

Chapter 7

MECHANICAL VENTILATION AND SMOKE CONTROL SYSTEMS

7.1. AIR-CONDITIONING & MECHANICAL VENTILATION SYSTEMS

7.1.1 General

- (a) Where air-conditioning system is provided in lieu of mechanical ventilation system during emergency, all the requirements specified in this Code for the mechanical ventilation system shall apply to the air-conditioning system.

(No illustration)

The term "air conditioning" has been defined by the American Society of Heating, Refrigerating, and Air Conditioning Engineers as:

"Air conditioning is the process of treating air so as to control simultaneously its temperature, humidity, cleanliness and distribution to meet the requirements of the conditioned space"

The use of air conditioning and mechanical ventilation systems will invariably, except for self-contained units, involve some use of pipe works for refrigerant/water circulation and ducts for air distribution and extraction.

The use of ducts present the inherent possibility of spreading fire, heat, gases and smoke throughout the building or the floors/areas served.

Where air conditioning system is designed to operate during fire emergency, it is to be emphasized that the system shall comply with all the relevant requirements for the mechanical ventilation system in this Code.

- (b) Construction of ductwork

Ducts for air-conditioning and mechanical ventilation systems shall be constructed in compliance with the following requirements:

- (i) All air-conditioning or other ventilation ducts including framing thereof, shall be constructed of steel, aluminium, glass-fibre batt or mineral-wool batt or other approved material.
- (ii) All air-conditioning or other ventilation ducts shall be adequately supported.
- (iii) Duct lining & coverings

Duct covering and lining should be non-combustible.

However, if it is necessary to use combustible material, it shall:-

- * when tested in accordance with methods specified in this Code, have a surface flame spread rating of not lower than Class 1, but in areas of building where Class 0 flame spreading rating is required for the ceiling construction under this Code, a Class 0 rating for the covering and lining materials shall be required;
- * when involved in fire generate a minimum amount of smoke and toxic gases; and
- * be at least 1.0m away from a fire damper.

(iv) Flexible joint and connection

Materials and installation of all flexible joints and connections shall be in accordance with SS CP 13 Code of Practice for Mechanical Ventilation and Air-conditioning in Buildings.

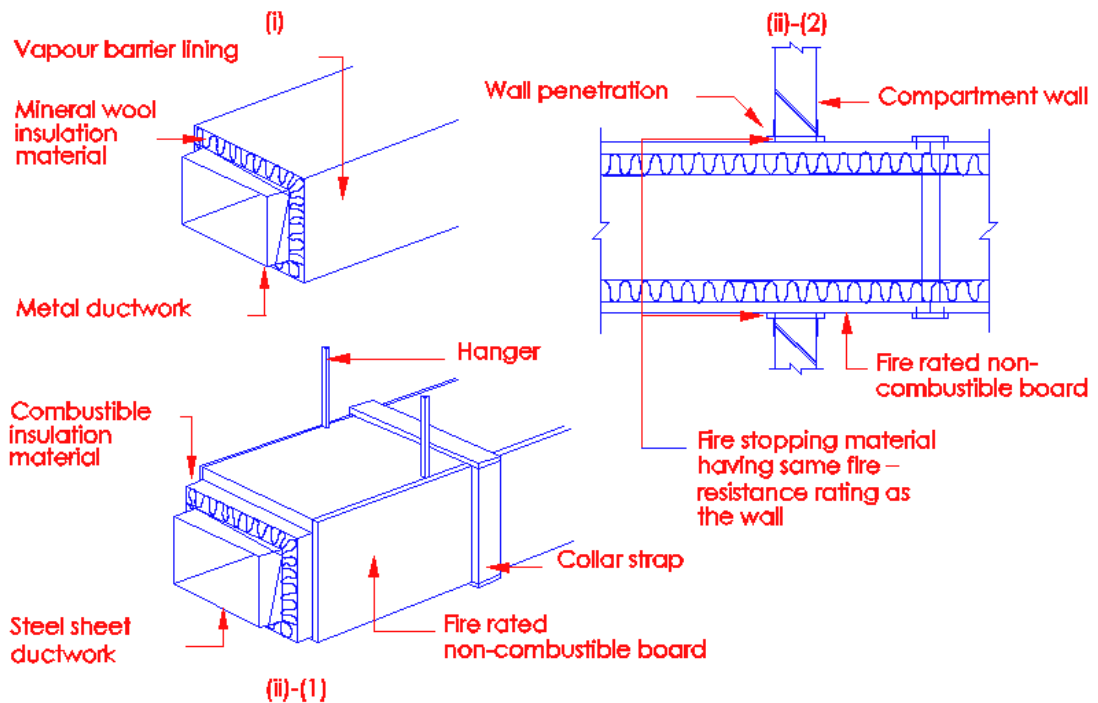

Diagram 7.1.1(b)

Minimum Class 1 for insulation material/barrier lining and adhesives. Where ceiling construction requires class 0, covering and lining insulation material shall also be class 0. Where combustible material is used for the insulation of the duct, it shall be kept at least 1000mm away from a fire damper in order to prevent premature closing of the damper arising from a fire from the combustible insulation material. For flexible joints and connections, which are combustible, there is a need to limit the length of the joints and connection to max. 250mm and 400mm respectively. Please see clause 1.2.35 in Volume 1 for illustration.

7.1.1 (c) Pipework insulation

Insulation for pipework associated with the air-conditioning and mechanical ventilation systems shall comply with the following requirements:

- (i) Insulation material for pipework together with vapour barrier lining and adhesives shall when tested in accordance with the methods specified in this Code, have a surface flame spread of not lower than Class 1 but in areas of buildings where Class 0 flame spread is required for the ceiling construction under this Code, a Class 0 rating for the insulation material shall be required.

- (ii) Plastic and foam rubber insulation

Notwithstanding the requirements of sub-clause (c)(i), the use of plastic and foam rubber insulation materials of a lower classification may be permissible if:

- * the material is the self-extinguishing type to the satisfaction of the Relevant Authority;
- * the insulation material is covered by or encased in a metal sheath or hybrid plaster or other non-combustible cladding materials acceptable to the Relevant Authority.

provided that any opening in the element of structure or other part of a building penetrated by the pipework shall be effectively fire-stopped by replacement of the insulation material at the junction of penetration with fire resistant material having equal fire rating. Fire rated proprietary pipework system may be used if it is tested in the manner acceptable to the Relevant Authority.

Metal pipes with combustible insulation

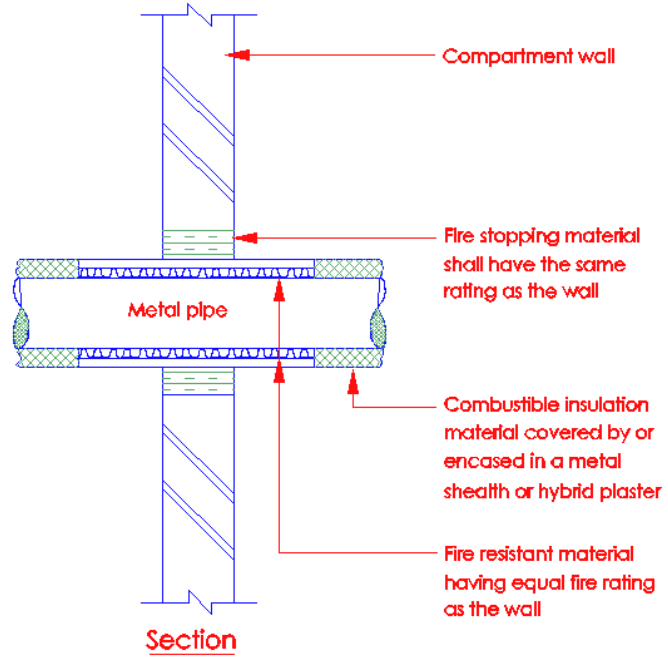

Diagram 7.1.1(c)-1

Metal pipes with non-combustible insulation

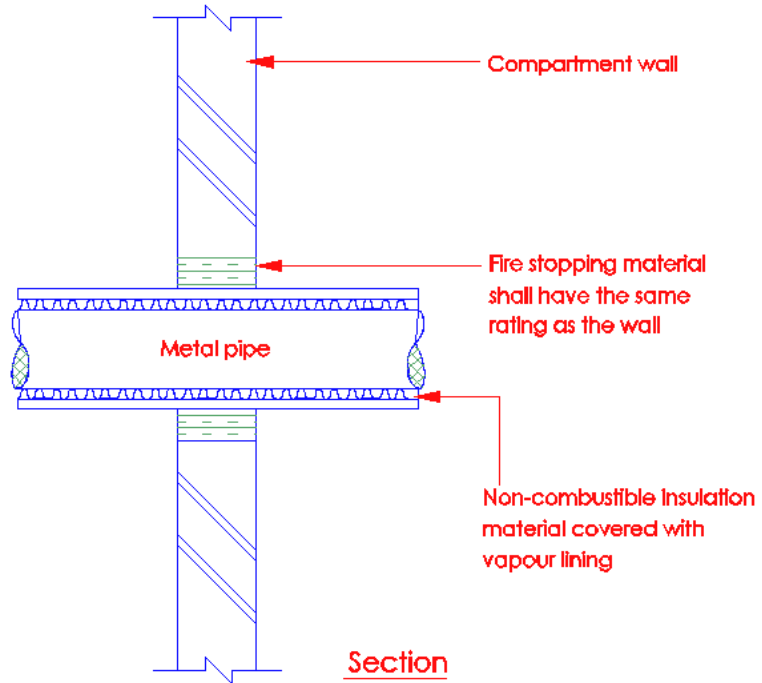
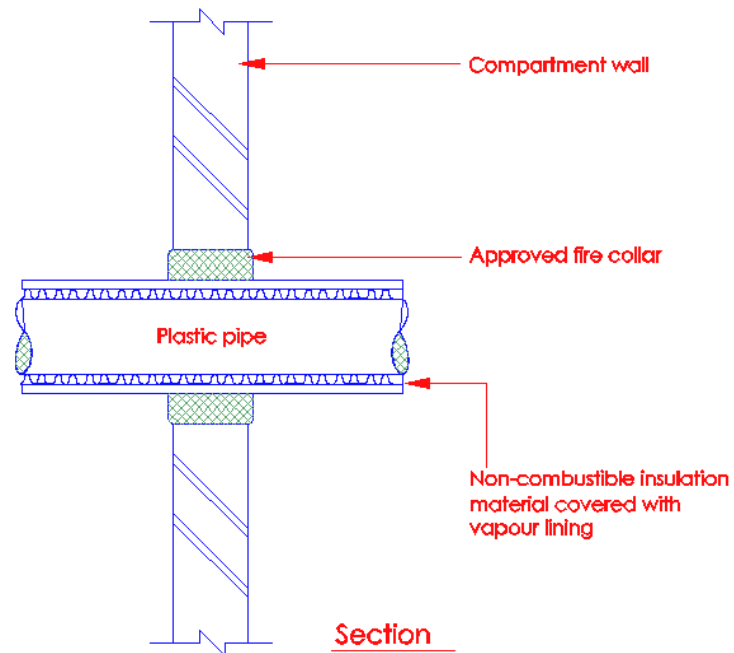

Diagram 7.1.1(c)-2

Plastic pipes with non-combustible insulation



Minimum class 1 for insulation material/barrier lining and adhesives. Where ceiling construction requires class 0, insulation material shall also be class 0. However, the use of 10mm to 15mm maximum diameter pipe works for split unit system would be considered as acceptable.

The use of fire collar shall be appropriate for the diameter of the PVC/UPVC pipe and shall be duly secured to the surface of the wall or floor with steel anchor bolts. See Table 3.9A of the fire code for the maximum nominal internal diameter of pipes.

(d) Duct enclosure

Enclosure of ducts shall comply with the requirements in sub-clause 3.8.9(a).

(No illustration)

A protected shaft used for the enclosure of services shall comply with the following:

- (a) *The protecting structure for protected shaft containing kitchen exhaust duct and mechanical ventilation ducts serving areas specified in Cl. 5.2.1(g)(i) to (iii) and (h) which pass through one or more floor slabs shall be constructed masonry. Such shaft shall be completely compartmented from the rest of the shaft space containing other ducts or any other services installations.*

Note: CL.5.2.1(g) –

- (i) exit staircases and exit passageway*
- (ii) smoke-stop lobby and fire fighting lobby*
- (iii) areas of refuge within the same building*

Cl.5.2.1(h) –

- (i) emergency generator*
engine driven fire pump

- (e) Ductwork through smoke-stop or fire fighting lobbies

Ventilation ducts should not pass through smoke-stop or fire fighting lobby. Where unavoidable, the part of the ventilation duct within the lobby shall be enclosed in construction with fire resistance rating at least equal to that of the elements of structure. Such construction shall be in masonry. If other form of fire resisting construction is used, fire damper shall be fitted where the duct penetrates the lobby enclosure.

Ventilation ducts are routed from The AHU Rooms directly into the office space

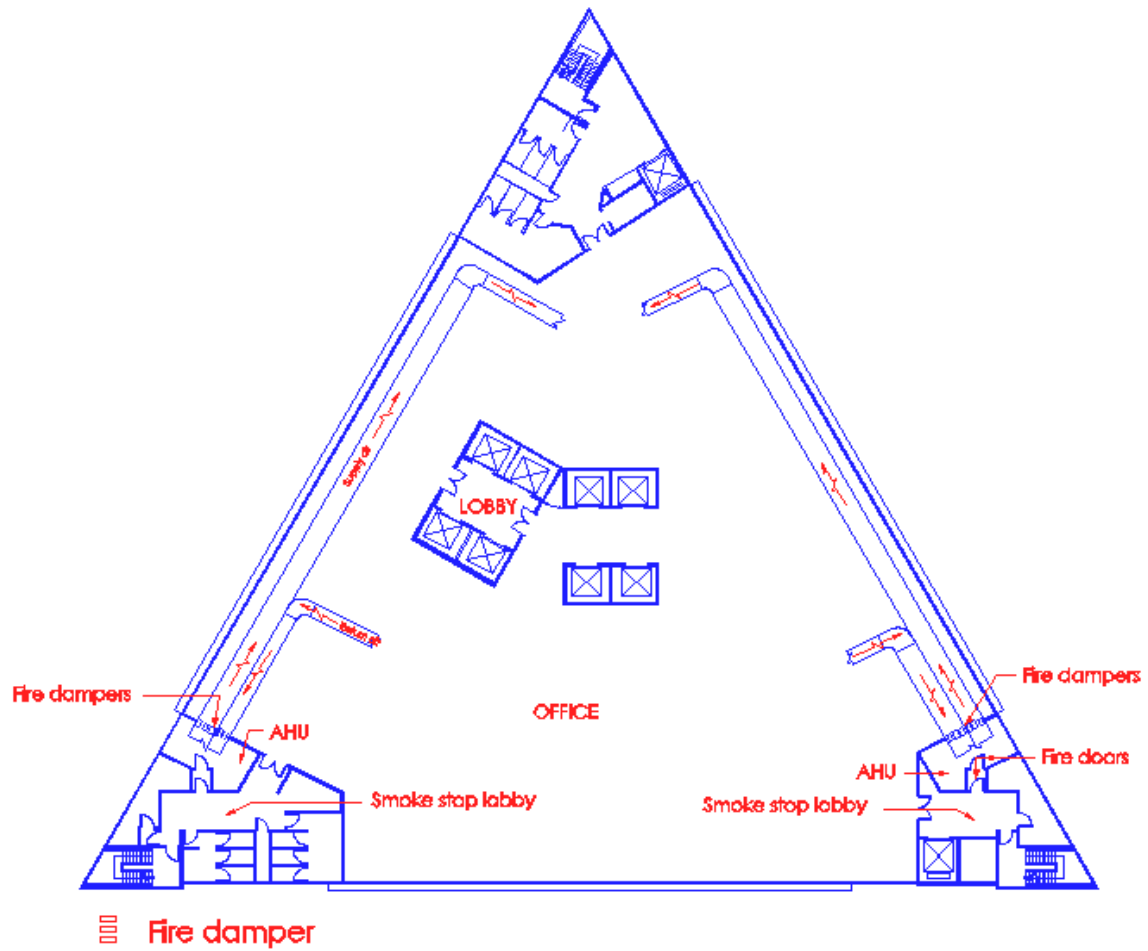

Diagram 7.1.1(e) - 1

With proper pre-planning, ventilation ducts are routed directly from the AHU rooms to occupancy areas, thus avoiding the routing through the protected lobby.

Ventilation ducts are routed along protected lobby

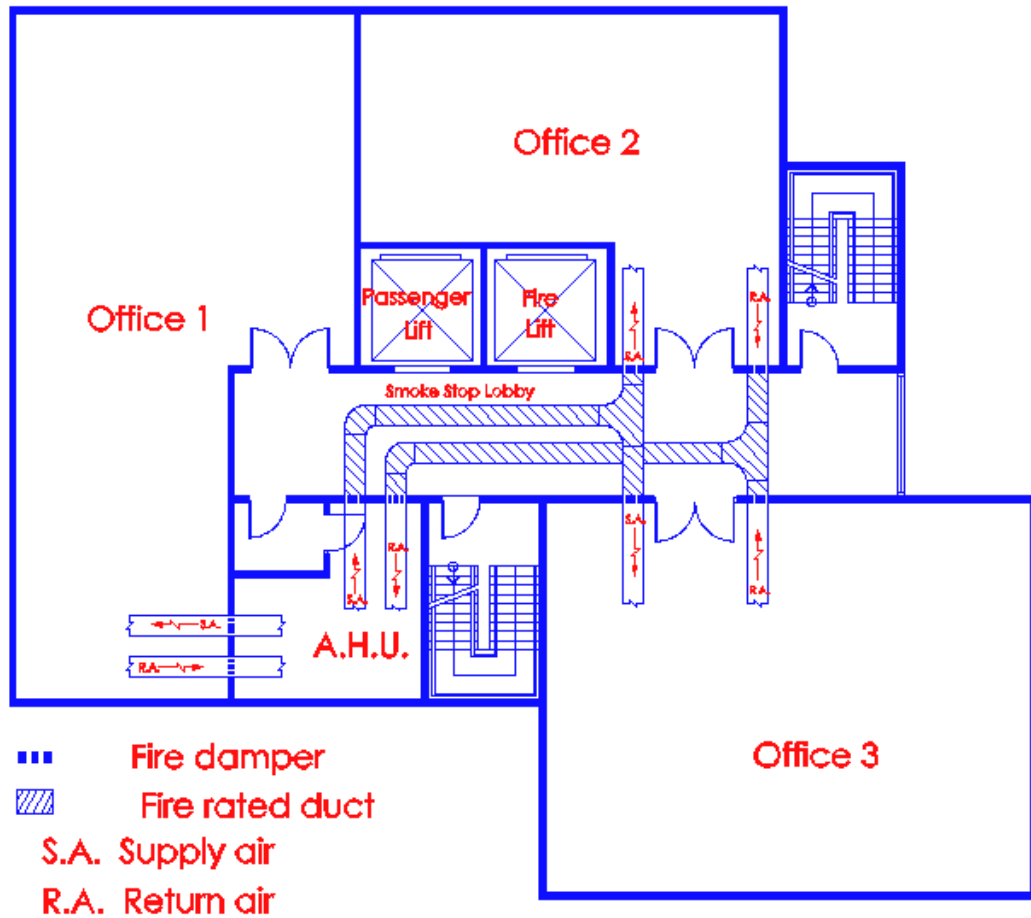

Diagram 7.1.1(e)-2

Ventilation ducts are routed along the Smoke Stop Lobby to serve Office 2 & 3. Routing the ventilation ducts through the fire lift or smoke stop lobbies should be avoided. "Unavoidable situations" where ventilation ducts were routed through the fire lift or smoke stop lobbies referred to existing building where physical constraints existed making it difficult to route the ventilation duct through other spaces other than the lobby area.

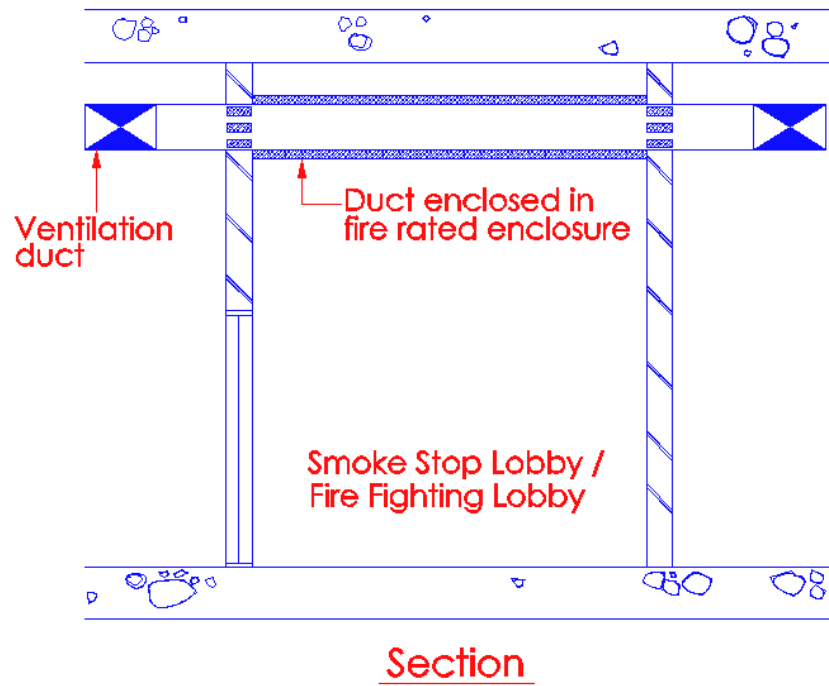
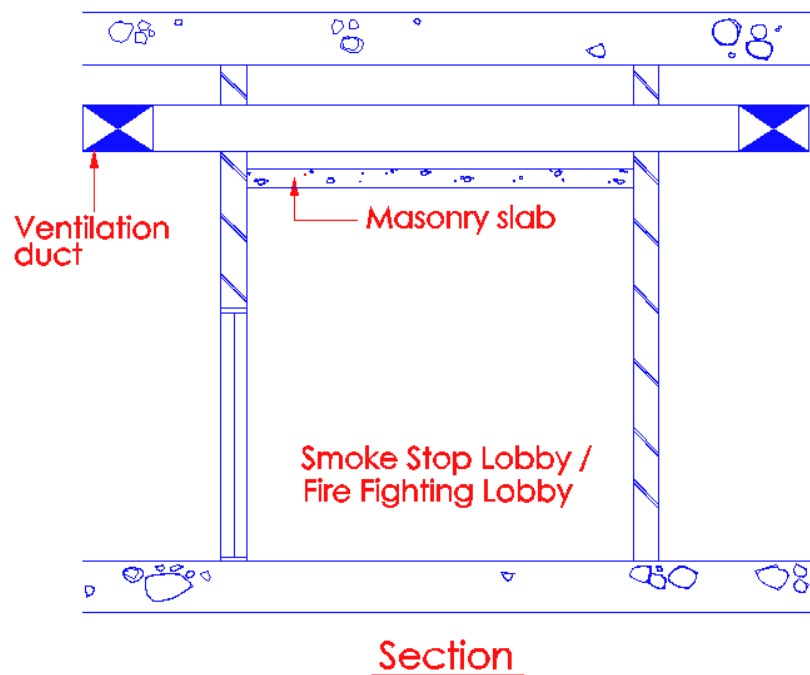

Diagram 7.1.1(e)-3

In addition to providing fire rated enclosure to the duct within the lobby, fire damper is fitted where the duct penetrates the lobby enclosure. Should a fire penetrates the fire damper, it still be contained within the duct.



The omission of fire damper to the duct where it penetrates the lobby enclosure is acceptable if a masonry slab is constructed below the duct to act as compartment ceiling. The masonry slab over the lobby completes the compartmentation, thus making the lobby a safe area.

(f) Plenum

A concealed space between the ceiling and floor above it, ceiling and roof, or raised floor and structural floor of a building may be used as a plenum provided that-

(i) The concealed space contains only:

- * mineral-insulated metal-sheathed cable, aluminium-sheathed cable, copper-sheathed cable, rigid metal conduit, enclosed metal trunking, flexible metal conduit, liquid-tight flexible metal conduit in lengths not more than 2 m, or metal-clad cables;
- * electric equipment that is permitted within the concealed spaces of such structures if the wiring materials, including fixtures, are suitable for the expected ambient temperature to which they will be subjected;
- * other ventilation ducts complying with sub-cl. (b);
- * communication cables for computers, television, telephone and inter-communication system;
- * fire protection installations;
- * pipes of non-combustible material conveying non-flammable liquids.

(ii) The supports for the ceiling membrane are of non-combustible material.

Return air plenum in ceiling space

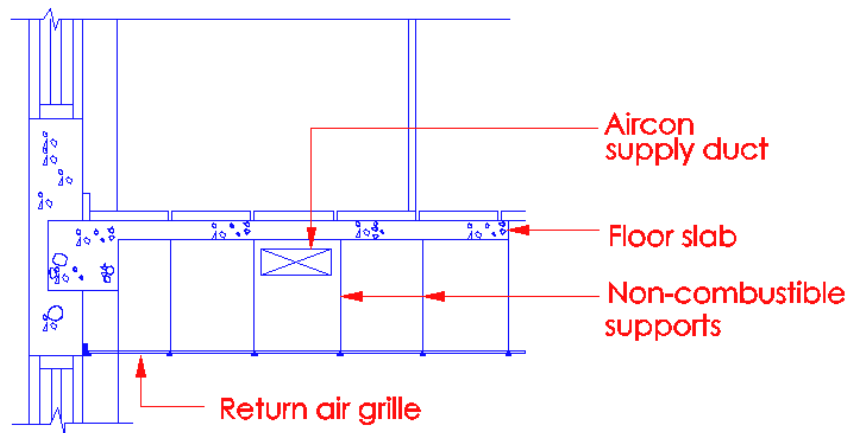

Section

Diagram 7.1.1(f)-1

Return air plenum in concealed space below raised floor

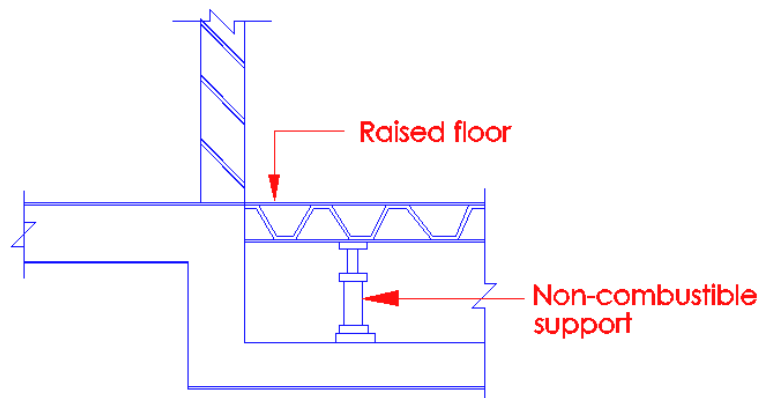

Section

Diagram 7.1.1(f)-2

A fire occurring in the concealed space would be difficult to detect. The smoke and heat could quickly spread beyond the origin of fire in the concealed space.

To restrict the unseen spread of smoke and heat in concealed spaces, additional fire safety requirements are imposed under f(i) and (ii).

(g) Separating walls

No air conditioning or ventilation ducts shall penetrate separating walls.

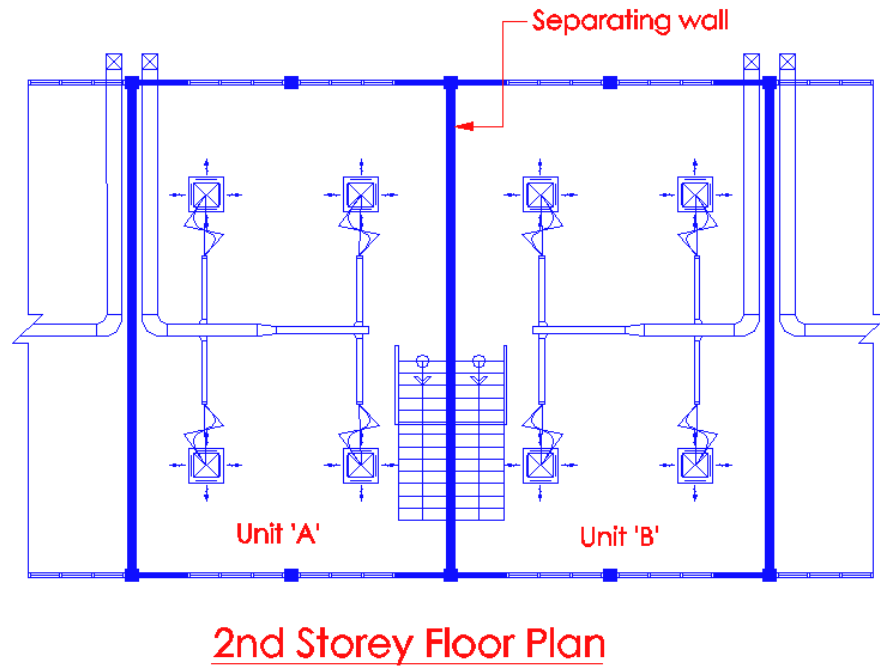

Diagram 7.1.1(g)

In terrace shophouses, the separating walls are also compartment walls, hence, there should be no sharing of air-con ducts.

In Commercial Complexes where shops/offices are located, the separating wall that separates one shop or office unit from another is not treated as compartment wall, as such, the requirement that air-con duct should not penetrate the separating wall should not apply.

(h) Provision of Fire Dampers

(i) Ventilation ducts which pass directly through a compartment wall or compartment floor shall comply with the following -

- * where the ventilation duct does not form a protected shaft or is not contained within a protecting structure, the duct shall be fitted with a fire damper where it passes through the compartment wall or compartment floor;

- * where the ventilation duct forms a protected shaft or is contained within a protecting structure, the duct shall be fitted with fire dampers at the inlets to the shaft and outlets from it.

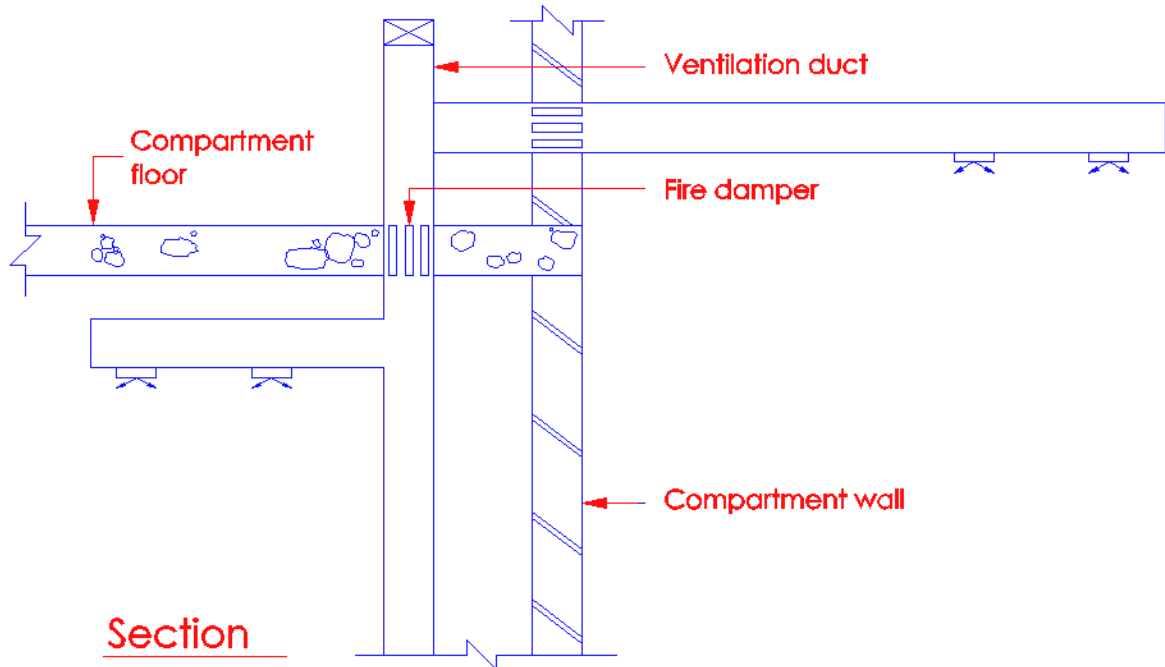

Diagram 7.1.1(h)(i)-1

Exposed ventilation duct is not fire rated. Fire damper is provided where it passes through the compartment floor or wall to prevent fire spread from compartment to compartment via the duct.

Exposed ventilation duct located outdoor shall be weather proof type. Fire rating the duct is not required.

Ventilation duct contained
Within protected shaft

Ventilation duct forms
A protected shaft

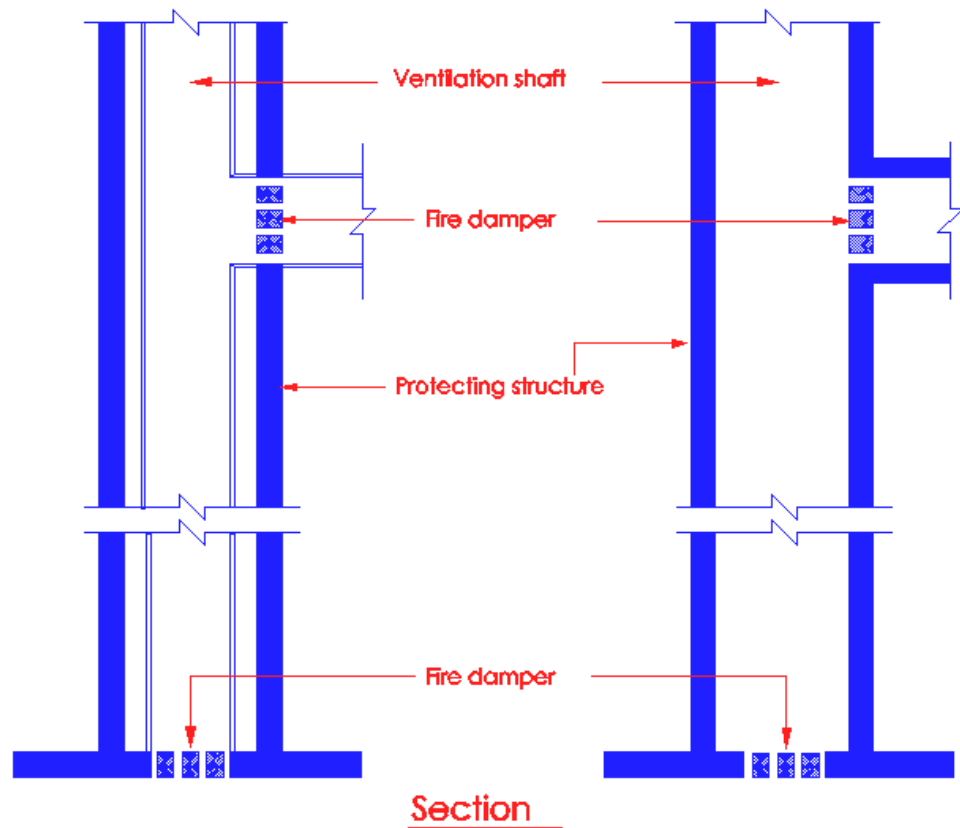

Diagram 7.1.1(h)(i)-2

To prevent fire spread from compartment to compartment via the duct, fire damper shall be provided at the inlets to the exhaust air shaft and outlets from supply air shaft.

The dampers shall be properly secured to the protecting structure or protected shaft to prevent any displacement.

Fire dampers are provided to inlets of exhaust air shafts
and outlets of supply air shaft

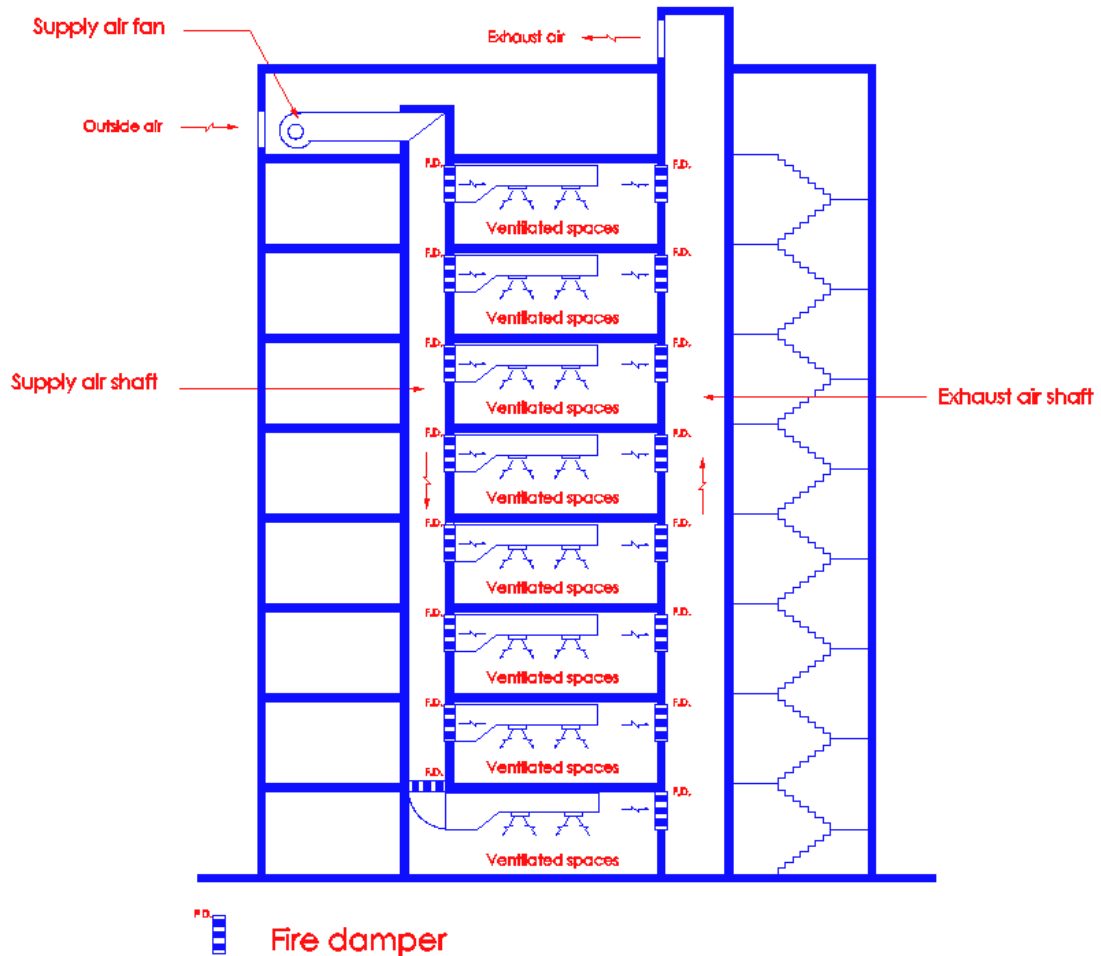

Diagram 7.1.1(h)(i)-3

(ii) Provision of fire dampers not required

Conditions under which fire dampers are not required to be fitted in openings of compartment walls and floors shall be in accordance with SS CP 13 Code of Practice for Mechanical Ventilation and Air-conditioning in Buildings.

Clause 6.4.5.3 of SS CP 13 allows the omission of fire dampers at openings in fire resisting walls when:

- (a) the opening has a horizontal supply branch duct passing through it and has a cross sectional area not greater than 0.02m^2 and is located at a height not greater than 1.2m above floor level and at distance not less than 6m from other similar unprotected opening; and
- (b) the opening is located at the wall of a return-air shaft which is fire rated and maintained at a negative pressure at all times and that air is discharged into the shaft through a sub duct of non-combustible material.

Normal direction of air flow downwards

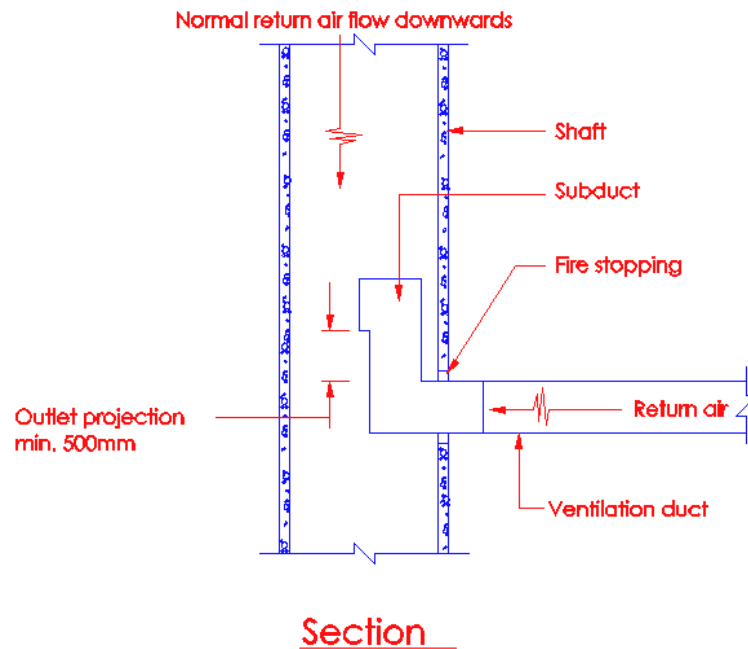

Diagram 7.1.1(h)(ii)

A subduct is an entry piece intended to prevent back flow (venturi effect) of air or products of combustion into non-fire affected compartments. It shall be manufactured from steel of 2mm minimum thickness or be otherwise constructed to have the same fire resistance rating as that required for the shaft.

An acceptable alternative material is reinforced concrete integral with the reinforced concrete shaft. If the above designs are to be adopted, QPs shall comply fully with the requirements listed under CL.6.4.5.3 of SS CP13 and full details shall be given on plan for approval.

- (h) (iii) Fire dampers shall not be fitted in the following locations:
- * openings in walls of a smoke extract shaft or return air shaft which also serves as a smoke extract shaft;
 - * openings in walls of a protected shaft when the openings have a kitchen exhaust duct passing through it; or
 - * anywhere in an air pressurising system;
 - * where explicitly prohibited in this Code.

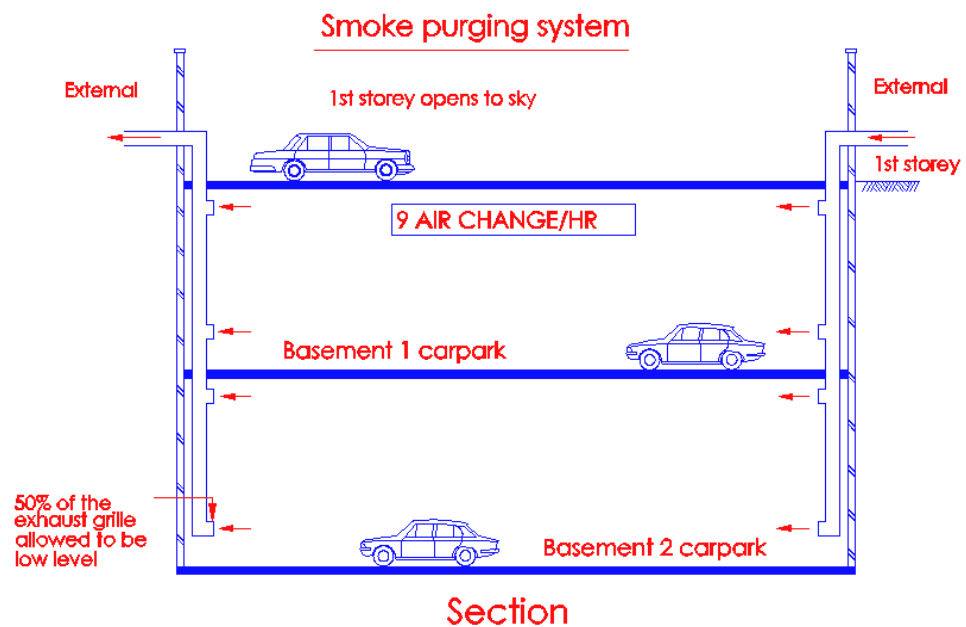

Diagram 7.1.1(h)(iii)

Fire dampers shall not be fitted in any of the smoke extract shaft. The smoke purging system would not be able to function effectively as the fire dampers when subjected to high temperature would close.

Smoke purging system is not intended for escape purposes but for dilution of smoke. Hence, there is no need to fire rate the duct works.

Fire dampers shall not be provided in the following locations:

- a) openings in walls of a protected shaft if such openings have a kitchen exhaust duct passing through them;
- b) anywhere in the supply duct work of air pressurising system to exit staircase; and
- c) anywhere in the supply and exhaust ducts serving fire pump room, generator room, fire command centre and flammable store.

- (iv) Where a fire damper is required by this Code to be installed in the airconditioning and mechanical system, its type, details of installation, connection of accessories, inspection door, etc. shall be in accordance with SS CP 13 Code of Practice for Mechanical Ventilation and Air-conditioning in Buildings. Construction of the fire damper shall comply with requirements in SS 333 Specifications of Fire Dampers.

(No illustration)

- (i) Fire resisting floor-ceiling and roof-ceiling

- (i) The space above a suspended ceiling which forms part of a fire-rated floor ceiling or roof-ceiling construction shall not contain ducting unless ducting was incorporated in a prototype that qualified for the required fire-resistance rating, in which case the ducting shall be identical to that incorporated in the tested prototype.

Ducting above fire rated ceiling or roof ceiling construction

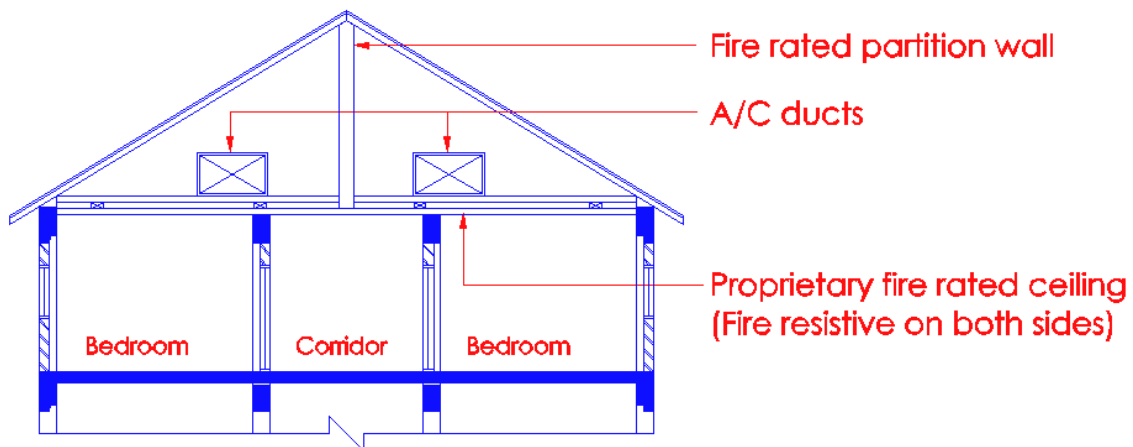

Diagram 7.1.1(i) - 1

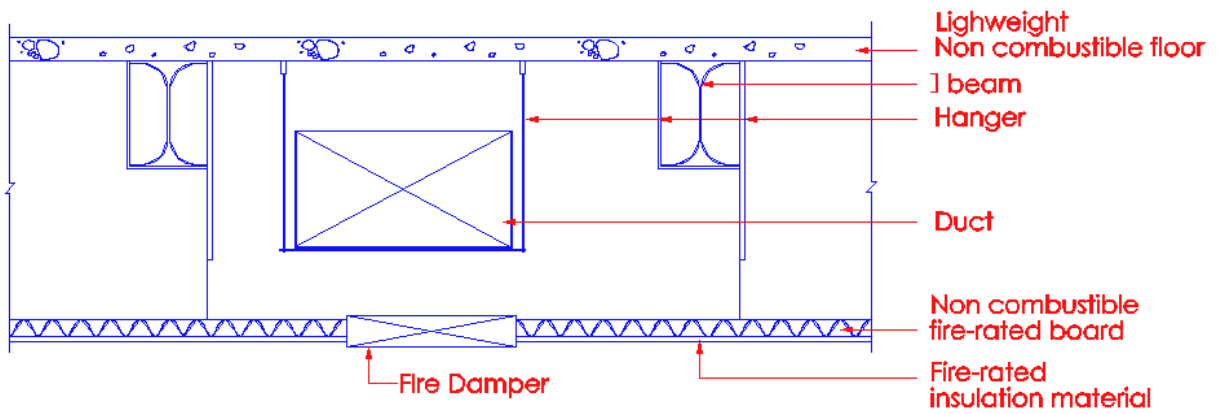

Diagram 7.1.1(i) – 2

Mechanical ventilation ducts are not permitted to be located in the concealed space of fire rated floor ceiling or roof ceiling assembly, unless such ducts are included in the prototype that was tested for the required fire resistance rating. The type of ducting within such ceiling or roof spaces as well as details of openings in such ceiling shall be identical to that incorporated in the tested prototype.

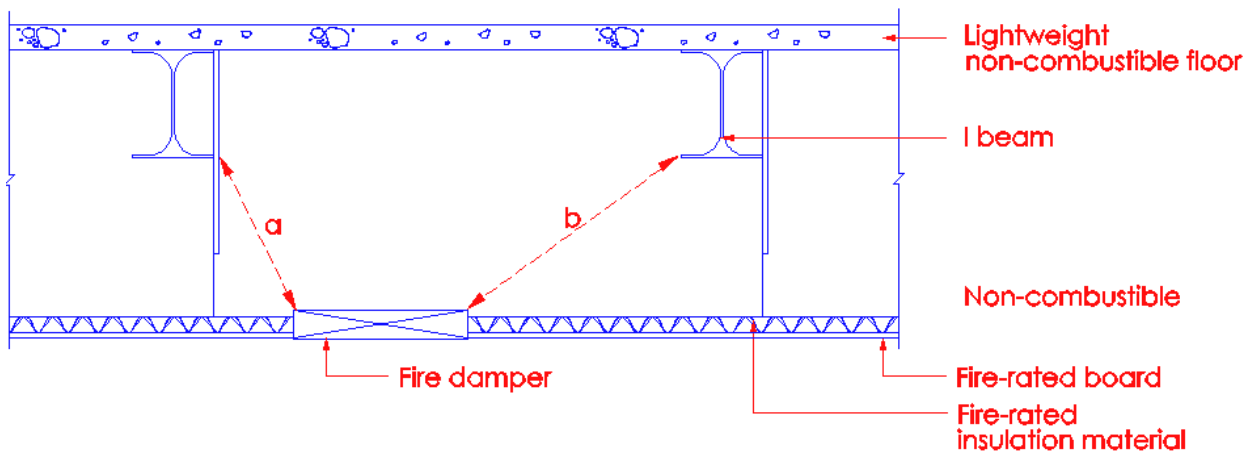

Diagram 7.1.1(ii)

- * Area of opening to be protected by fire damper shall not be greater or larger than that in the prototype test panel.
- * Total area of openings in the ceiling to each compartment shall not be greater than that of the prototype test panel.
- * The opening for fire damper may be relocated provided the proximity to structural member (a and b) eg. column, beams and structural walls is not less than that in the prototype test panel.

During a fire, the radiant heat from the fire damper would affect the performance of the structural members eg. I-beam in the ceiling space. Hence, the distance between any opening to any structural member shall not be less than that in the prototype test panel.

7.1.1(i)

(ii) Openings in the ceiling, including openings to enable the ceiling to be used as a plenum, shall be protected by fire dampers identical to those used in the tested prototype and such openings in the ceiling shall be so arranged that –

- * No opening is greater in area than that corresponding in the prototype test panel;
- * The aggregate area of the openings per unit ceiling area does not exceed that of the prototype test panel; and
- * The proximity of any opening to any structural member is not less than that in the prototype test panel.

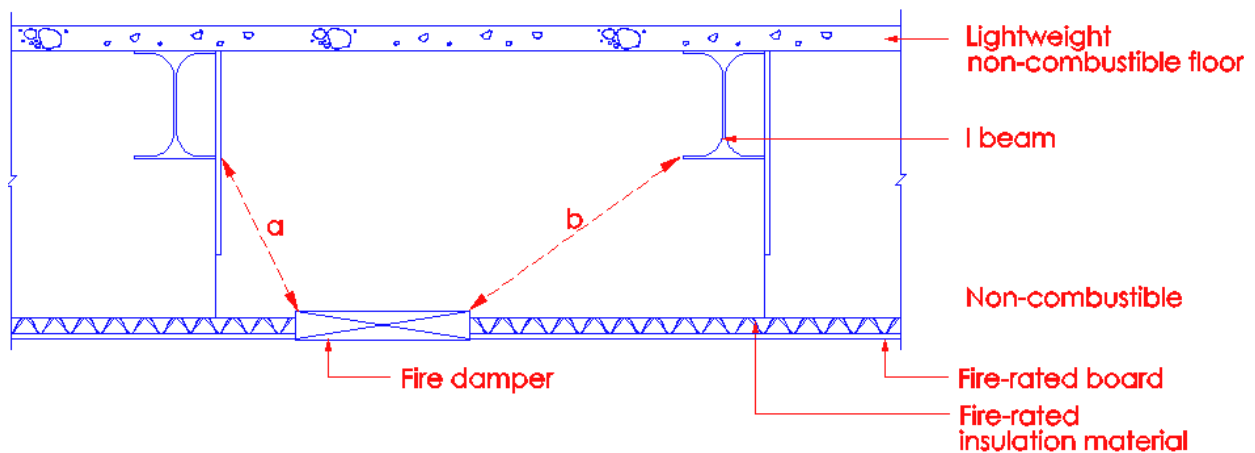

Diagram 7.1.1(ii)

- * Area of opening to be protected by fire damper shall not be greater or larger than that in the prototype test panel.
- * Total area of openings in the ceiling to each compartment shall not be greater than that of the prototype test panel.
- * The opening for fire damper may be relocated provided the proximity (a and b) to structural member eg. column, beams and structural walls is not less than that in the prototype test panel.

During a fire, the radiant heat from the fire damper would affect the performance of the structural members eg. I-beam in the ceiling space. Hence, the distance between any opening to any structural member shall not be less than that in the prototype test panel.

- * The opening (A & B) may be relocated within the ceiling area provided the proximity to structural member, eg. column, beams and structural walls is not less than that in the prototype test panel.

(j) Fire Rated Duct

- (i) Where proprietary fire rated materials are used to construct the fire rated duct, the fire rating of the fire rated shall have the same period of fire resistance as the wall or floor it penetrates.
- (ii) Proprietary fire rated duct shall be tested to BS 476 Pt 24 or equivalent and its usage be approved by the Relevant Authority.
- (iii) Running of non-fire rated duct and/or other building services above the proprietary fire rated duct should be avoided. When unavoidable due to physical constraints, the supports to such non-fire rated duct and/or other building services running above the proprietary fire rated duct shall be strengthened such that the tensile stress generated on the supports shall not exceed 10N/mm² and the non-fire rated duct and/or building services shall also be adequately protected to prevent collapse in a fire which will otherwise affect the stability of the proprietary fire rated duct below.

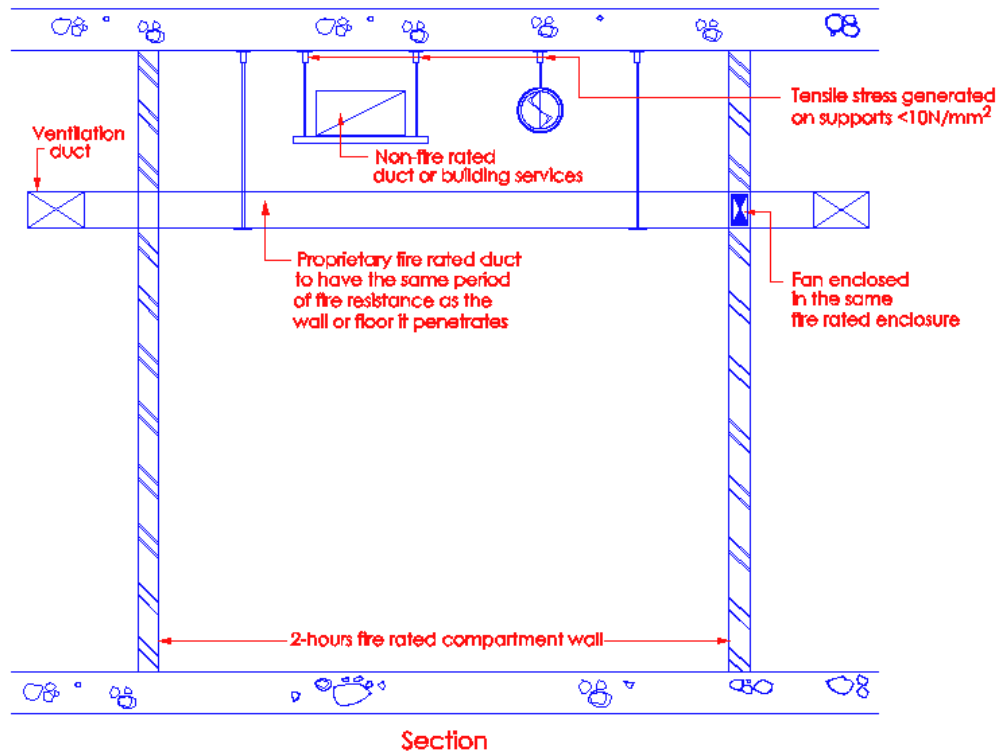

Diagram 7.1.1 (i) (iii)

- (iv) Fans forming part of a fire rated duct shall also be enclosed in the same fire rated enclosure.

(No illustration)

7.1.2 Air handling unit room

- (a) Air handling unit rooms

Rooms having no other usage than housing air handling equipment or package units, and their associated electrical controls are not regarded as areas of high risk. However, in situations where the air handling equipment serves more than one compartment, fire dampers shall be provided in air ducts at penetration through the compartment walls and floors to comply with the requirements in Cl.7.1.1 (h).

- (b) Smoke detectors

Smoke detectors of approved type shall be incorporated in the return air stream immediately adjacent to:

- (i) air handling units serving more than one storey or compartment; or
 - (ii) a single unit in excess of 15000m³/h; or
 - (iii) any AHU as may be required by the Relevant Authority.
- (c) The function of smoke detectors where required by this code is to initiate action to shut down the AHU automatically when the smoke density in the return-air has become unacceptable for recycling. Details of the requirements shall be in accordance with SS CP 13 Code of Practice for Mechanical Ventilation and Air-conditioning in Buildings.

An AHU serving 2 fire compartments

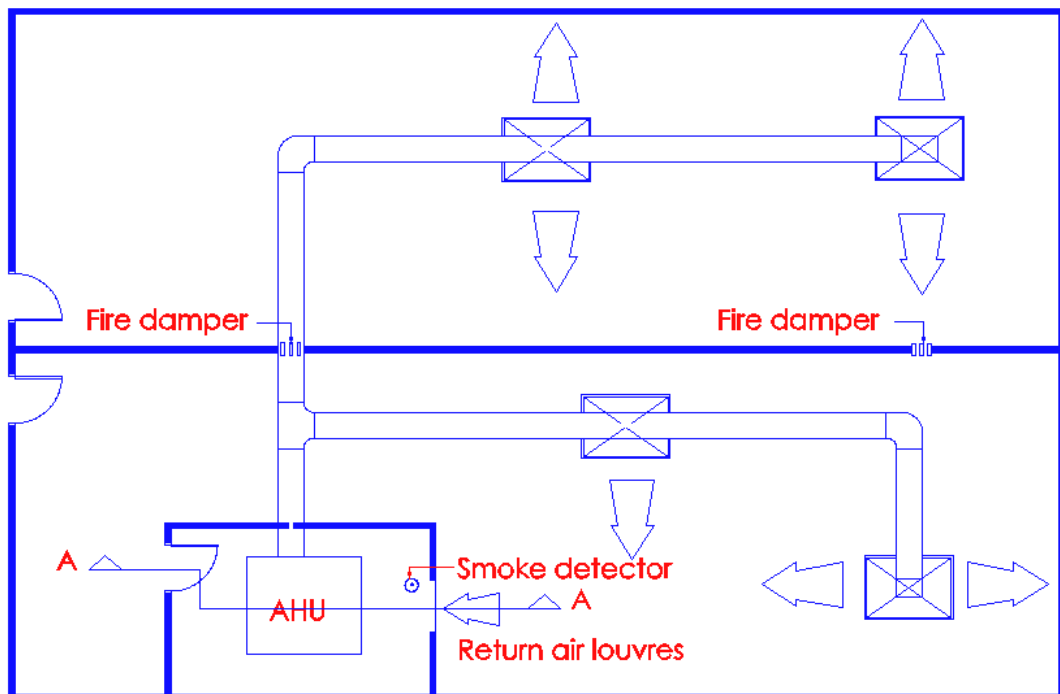
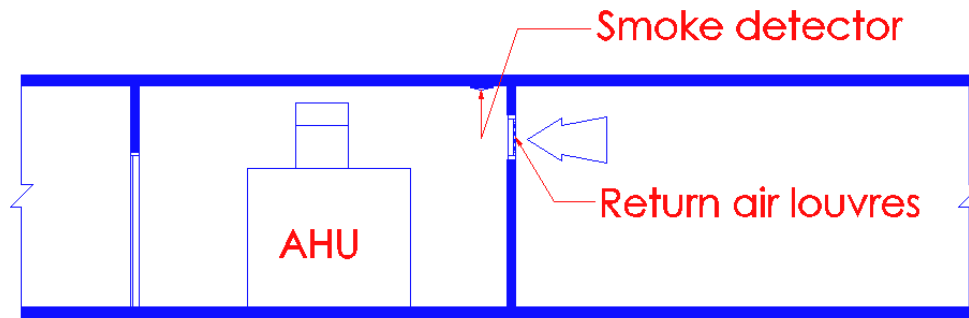

Diagram 7.1.2 - 1



SECTION A-A

Air duct penetrating a compartment wall being fitted with a fire damper

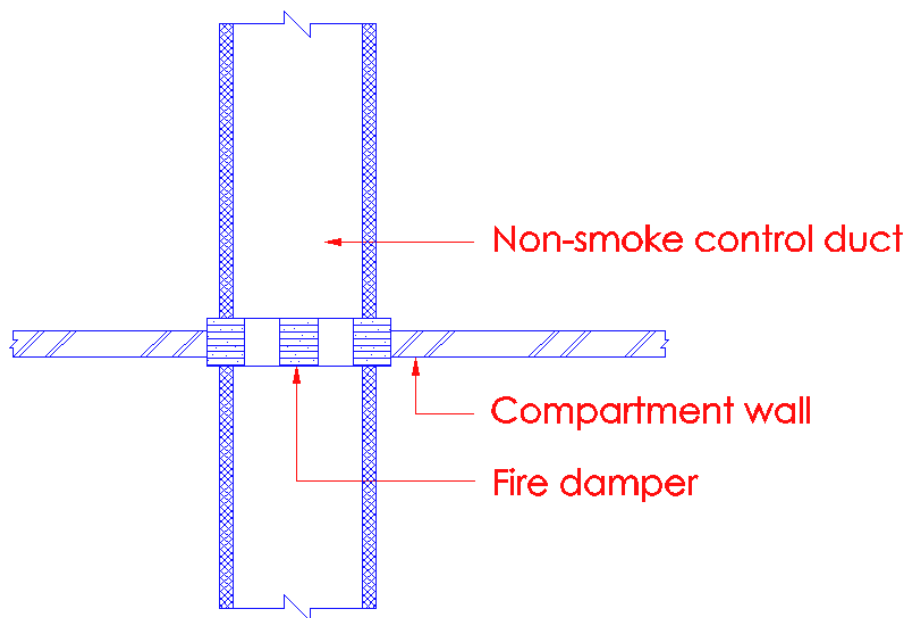

Diagram 7.1.2-2

To prevent the spread of smoke and flame from one fire compartment to another served by a single AHU, smoke detector shall be incorporated in the return air stream adjacent to air handling unit. The smoke detector is to initiate action to shut down the AHU automatically when smoke is drawn into return air system. The fire damper located in the fire compartment wall or floor where the air duct penetrated would only be activated by a fire in any of the compartment. The closing of the fire damper would prevent the spread of fire and, to some extent, the spread of smoke from one compartment to another.

7.1.3

Exits

- (a) Protected shaft of exits, smoke-stop lobbies, including its concealed space shall not be used for supply, exhaust or return air plenum of air handling systems.

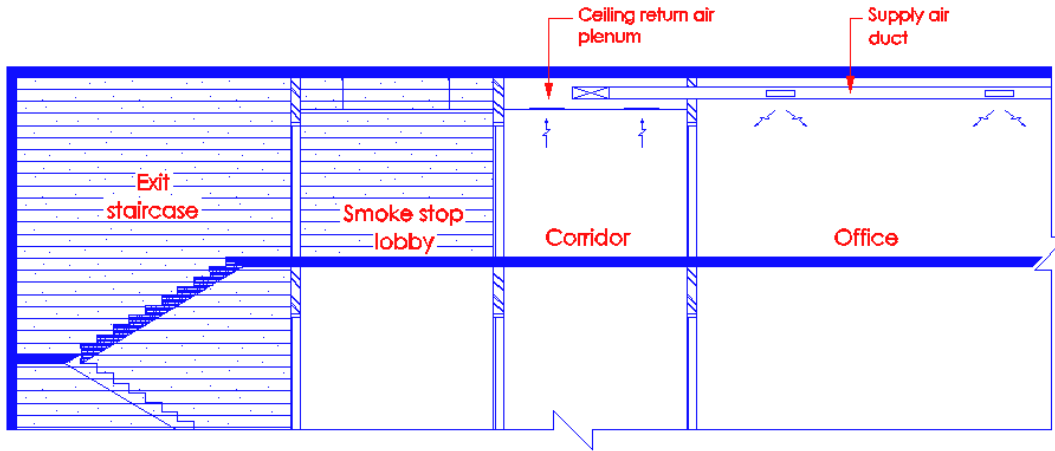

Protected spaces - shall not be used as air plenum. Concealed space of exits or smoke stop lobbies, such as concealed ceiling space or raised floor shall not be used as supply, exhaust or return air plenum of air handling systems.

Diagram 7.1.3(a)

The protection of these spaces as means of escape is important. They must not be used as air plenum by other systems.

7.1.3

- (b) Mechanical ventilation system for each exit staircase and internal exit passageway, if provided, shall be an independent system of supply mode only exclusive to the particular staircase, and it shall comply with the following requirements:
- (i) Supply air for the system shall be drawn directly from the external, with intake point not less than 5 m from any exhaust discharge openings.
 - (ii) For exit staircase serving more than 4 storeys, supply air shall be conveyed via a vertical duct extending throughout the staircase height and discharging from outlets distributed at alternate floor.

M/V to exit staircase and internal exit passageway

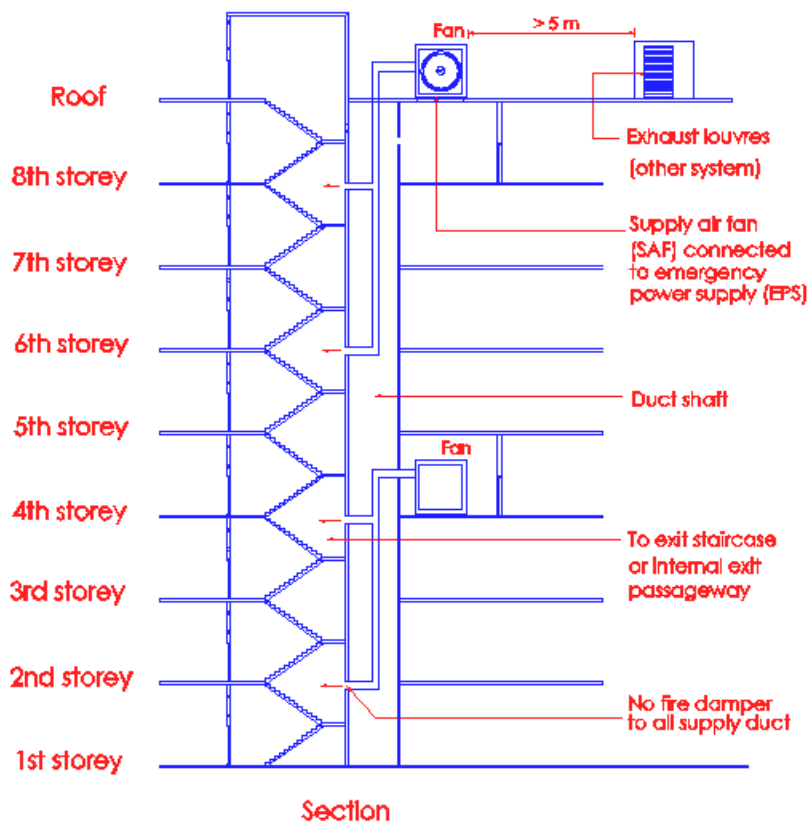

Diagram 7.1.3(b)(i)

There is a need to separate supply air fan from the exhaust louvres by at least 5m measured from the edge of the exhaust louvres housing. This is to prevent the possibility of smoke being drawn into the supply air shaft.

For maintaining uniformity of air distribution in the staircase it would be desirable to place the supply air outlet at every floor level, but should not be more than alternate floors. The supply air system to the staircase shall be an independent system as it is expected to operate during emergency to provide smoke free environment to serve occupants evacuating in the staircase.

- (iii) Where the supply air duct serving the exit staircase has to penetrate the staircase enclosure, the portion of the duct where it traverses outside the staircase shall be enclosed in masonry construction of at least the same fire resistance as the element of structure and it shall not be fitted with fire dampers.

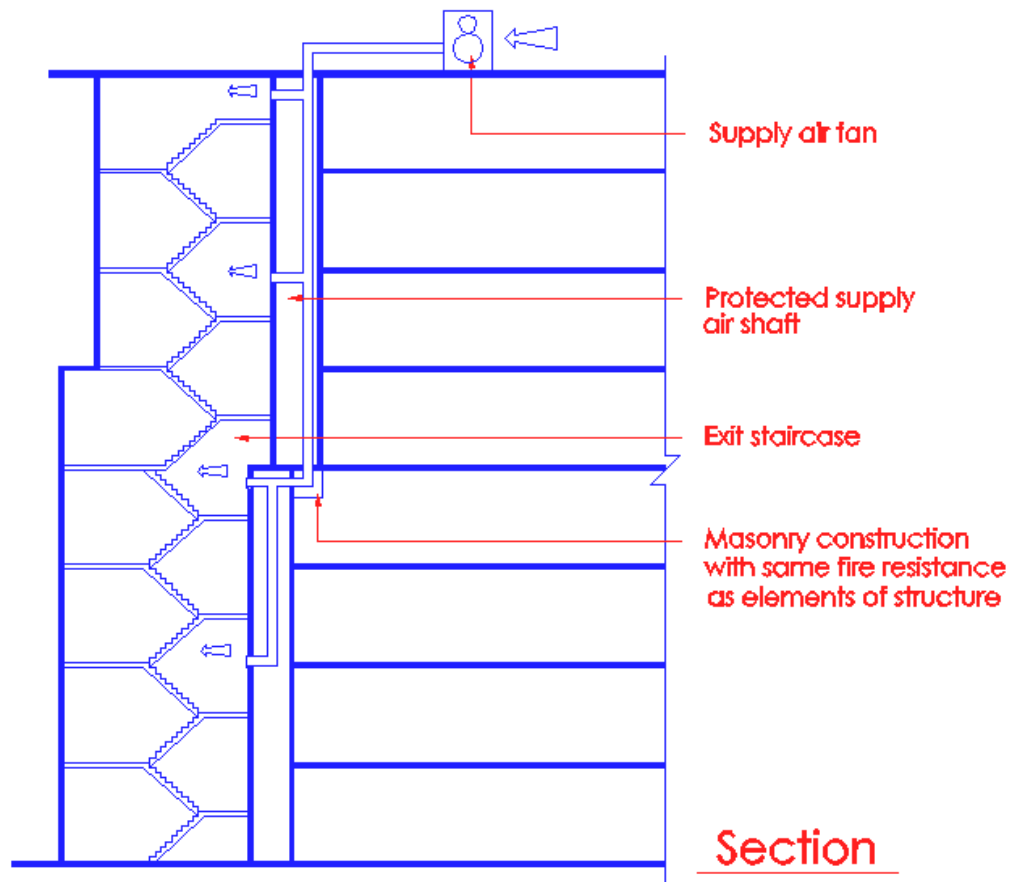

Diagram 7.1.3(b) (iii)

The supply air duct is considered as part of the exit staircase, as such that part of the duct, which traverses outside, shall be protected with masonry. As exit staircase is the means of escape, protecting it with masonry would ensure the durability of the shaft during fire situation.

As far as possible, the supply air duct should be located within the protected shaft, unless it is unavoidable.

7.1.4 Mechanical ventilated smoke-stop lobby and fire fighting lobby

Mechanical ventilation system for smoke-stop lobbies and fire fighting lobbies shall be a system exclusive to these lobbies, and it shall comply with the following requirements:

- (a) The ventilation system shall be of supply mode only of not less than 10 air changes per hour.
- (b) Supply air shall be drawn directly from the external with intake point not less than 5m from any exhaust discharge or openings for natural ventilation.

- (c) Any part of the supply duct running outside the smoke-stop or fire fighting lobby which it serves shall either be enclosed or constructed to give a fire resistance rating of at least 1 hr. The Relevant Authority may at its discretion require a higher fire resistance rating if the duct passes through an area of high fire risk.
- (d) The mechanical ventilation system shall be automatically activated by the building fire alarm system. In addition, a remote manual start-stop switch shall be made available to firemen at the fire command centre, or at the fire indicating board where there is no fire command centre. Visual indication of the operation status of the mechanical ventilation system shall be provided.

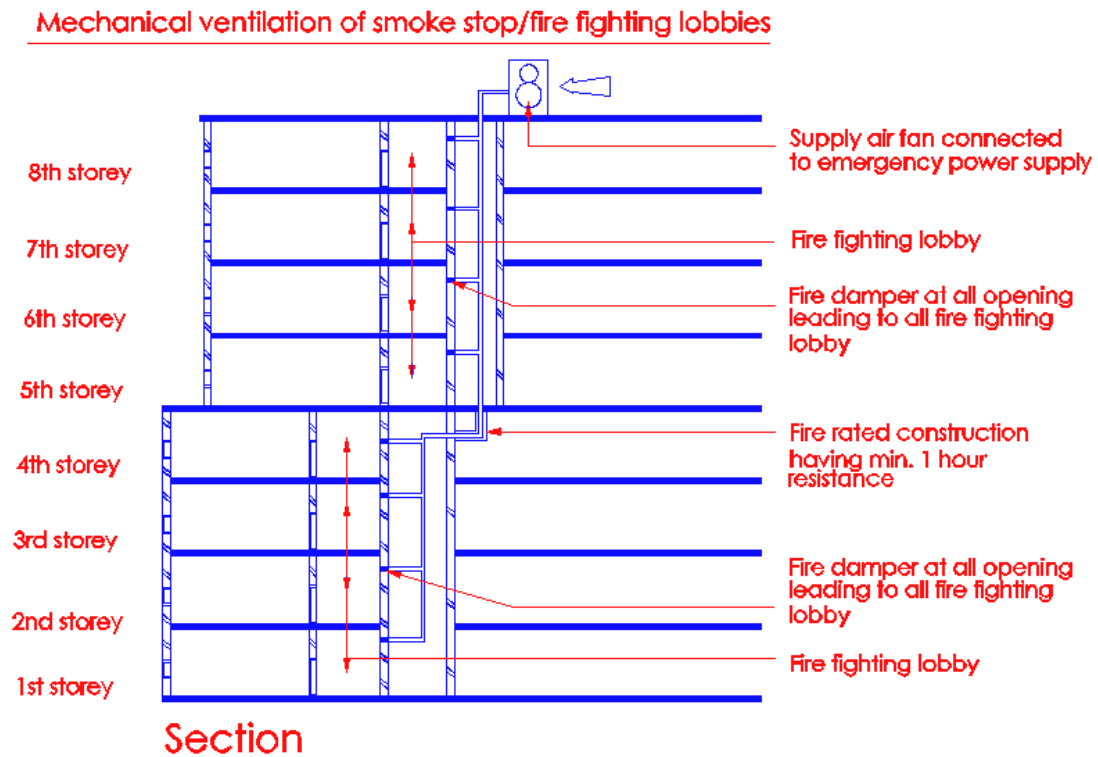

Diagram 7.1.4(c)

The above diagram shows that the supply air duct to the smoke stop lobbies or fire fighting lobbies is provided with fire damper where it penetrates the compartment wall of the lobby. This is to ensure that the floor to floor compartmentation is maintained.

The portion of the duct which traverse outside the protected shaft is enclosed in fire rated construction e.g. fire rated boards.

The main purposes of locating the manual start/stop switch with visual indication at the fire command centre, or at the main fire indicating board (FIB) where there is no fire command centre are:

- a) to allow fire fighting personnel to shut down the supply air system temporarily in the event that smoke is being drawn into the lobby through the outdoor air intake; and*
- b) to allow fire fighting personnel to activate the supply air system should the fire alarm system fail to automatically activate the supply air system.*

7.1.5 Engine driven fire pump and generator room

Where mechanical ventilation is installed to provide air for the operation of the following equipment, such system shall be independent of each other and any other system serving other parts of the building:

- engine driven fire pump;
- emergency generator;

- (a) Supply air shall be drawn directly from the external and its intake point shall not be less than 5 m from any exhaust discharge openings. Exhaust discharge shall also be direct to the external and shall not be less than 5 m from any air intake openings.

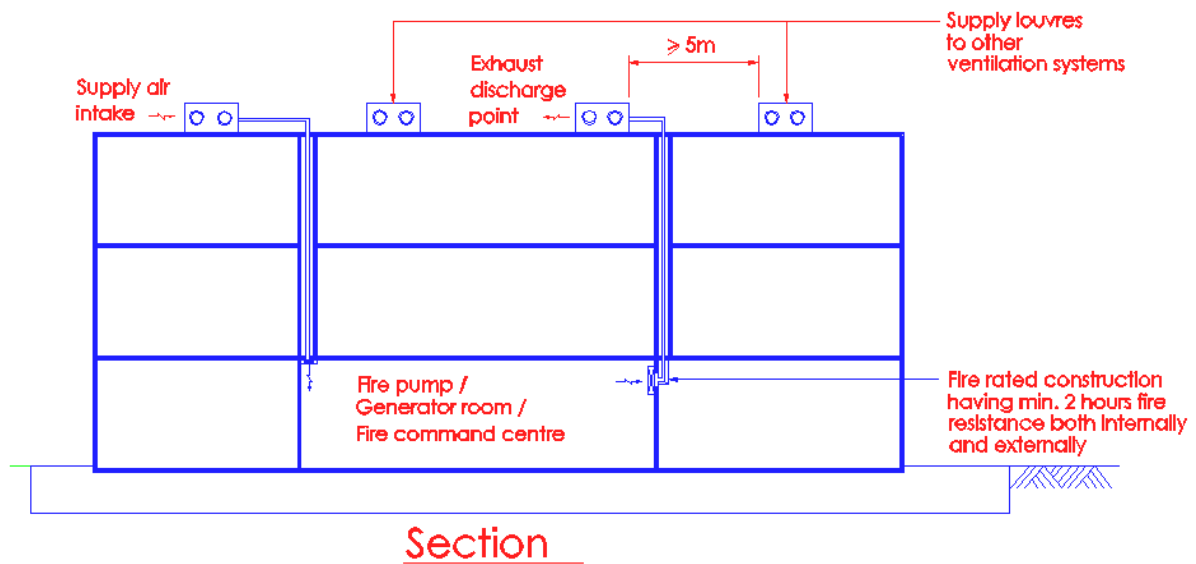

Fire pumps include sprinkler, wet riser, transfer pumps

Diagram 7.1.5(a)

The 5m clearance between supply and exhaust units refers to the horizontal distance. This is to prevent the recycling of exhaust air back into the building.

- (b) Where the corresponding ducts run outside the room they shall either be enclosed in a structure or be constructed to give at least the same fire rating as the room which they serve or that of the room through which they traverse, whichever is higher. The rating shall apply to fire exposure from both internal and external of the duct or structure. Where the duct risers are required to be enclosed in a masonry shaft, or dry wall complying with Cl. 3.8.9(a), they shall be compartmented from the rest of the shaft space containing other ducts or services installations.
- (c) No fire damper shall be fitted in either supply or exhaust duct required under this clause.

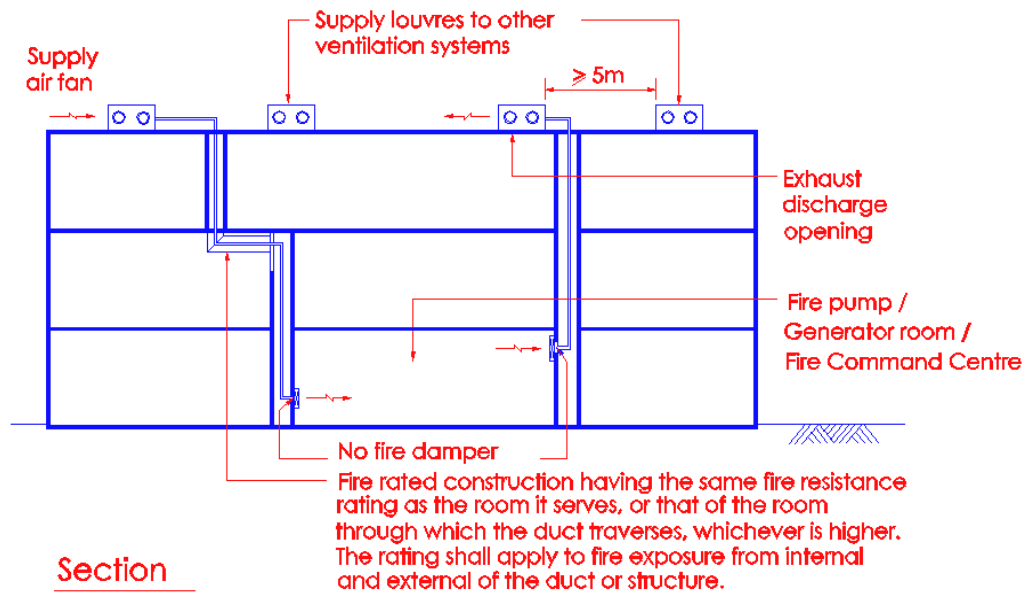
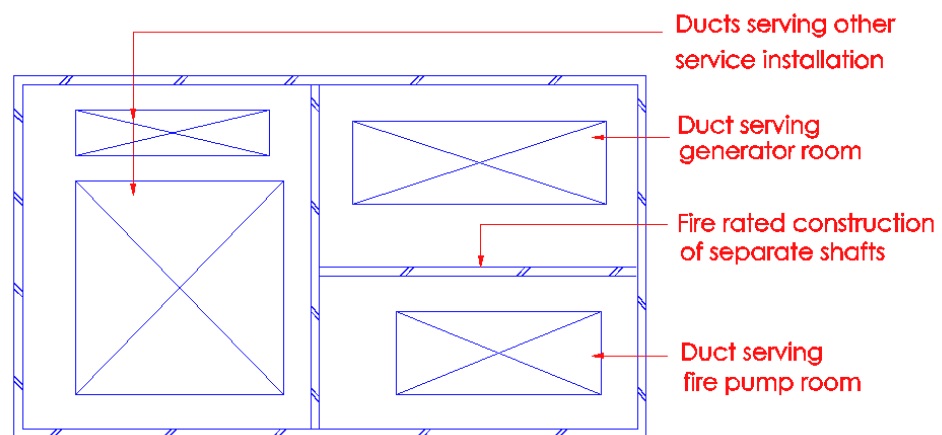

Diagram 7.1.5(b) - 1

The above diagram shows that the ducts that run outside the protected masonry shaft are enclosed in a structure or be constructed to give the necessary fire resistance rating.

However, for the riser ducts, which pass through one or more floors, they are required to be enclosed in fire rated shaft as required under Cl.3.8.9. This is to ensure that the riser ducts are properly protected.

The provision of fire damper to the supply and exhaust ducts is not permitted as the supply or exhaust system is required to function during emergency.



Plan of protected shaft

Diagram 7.1.5(b) - 2

As the mechanical ventilation system to generator room and fire pump room is independent of each other, the riser duct for each system shall be separately enclosed in a masonry shaft and compartmented from the rest of the shaft space containing other ducts or service installations.

- (d) Duct serving areas other than rooms housing equipment stated in this clause shall not pass through such rooms.

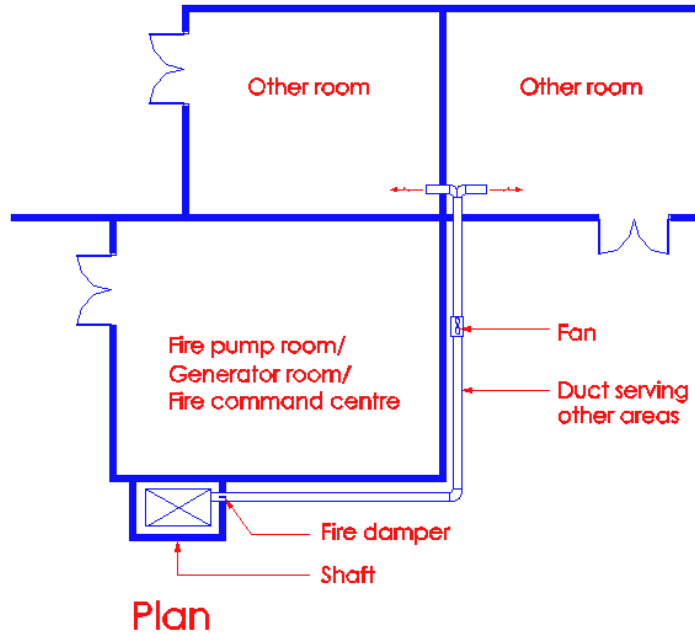

Diagram 7.1.5(d)

Ducts serving other areas shall not pass through the fire pump room, generator room and fire command centre. The above diagram shows that the ventilation duct is diverted to avoid traversing the aforesaid rooms.

7.1.6 Fire command centre

Where mechanical ventilation is required for the fire command centre, such system shall be independent of each other and any other system serving other parts of the building. It shall also comply with the following requirements:

- (a) Supply air shall be drawn directly from the external and its intake point shall not be less than 5m from any exhaust discharge openings. Exhaust discharge shall also be direct to the external and shall not be less than 5m from any air intake openings.

- (b) Where the corresponding ducts run outside the fire command centre, they shall either be enclosed in a structure or be constructed to give at least the same fire rating as the room which they serve or that of the room through which they traverse, whichever is higher. Where the duct risers are required to be enclosed in a masonry shaft, or dry wall complying with Cl. 3.8.9(e) they shall be compartmented from the rest of the shaft space containing other ducts or services installations.
- (c) No fire damper shall be fitted in either supply or exhaust duct required under this Clause.
- (d) Duct serving areas other than the fire command centre shall not pass through the room.

For illustration of the above see Cl.7.1.5(a) to (d)

7.1.7 Kitchen

- (a) *Mechanical exhaust system for the cooking area of a kitchen in a hotel, restaurant, coffee house or the like shall be independent of those serving other parts of the building. It shall also comply with the following requirements:*
 - (i) *The hood and ducts for the exhaust shall have a clearance of 500mm from unprotected combustible materials;*

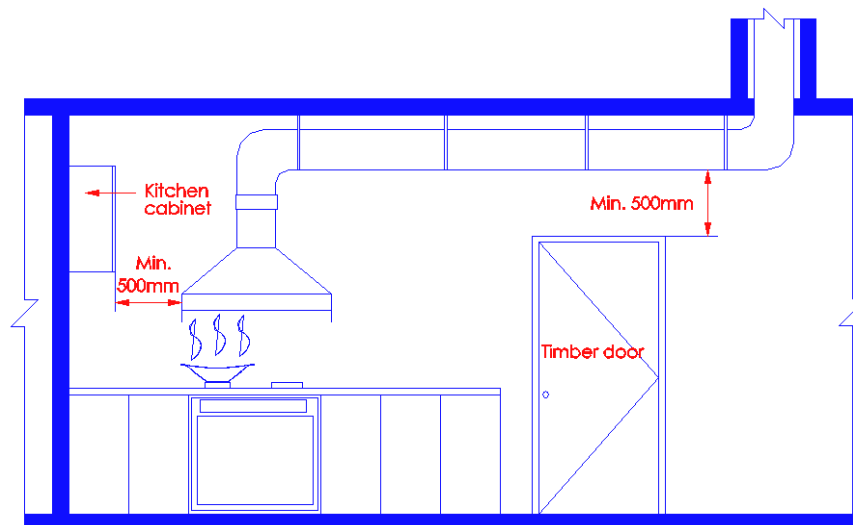

Diagram 7.1.7(a)(i)

The hood and duct should be separated from other combustible materials by a minimum horizontal clearance of 500mm to prevent ignition through heat radiation.

- (ii) The exhaust shall be discharged directly to the external and shall not be less than 5m from any air intake openings;
- (iii) The exhaust duct where it runs outside the kitchen shall either be enclosed in a structure or be constructed to give at least the same fire rating as the kitchen or that of the room it traverses, whichever is higher. The rating shall apply to fire exposure from both internal and external of the duct or structure. Where the duct riser is required to be enclosed in a protected shaft constructed of masonry or dry wall complying with Cl. 3.8.9(a), it shall be compartmented from the rest of the shaft space containing other ducts or services installations; and
- (iv) No fire damper shall be fitted in kitchen exhaust ducts.

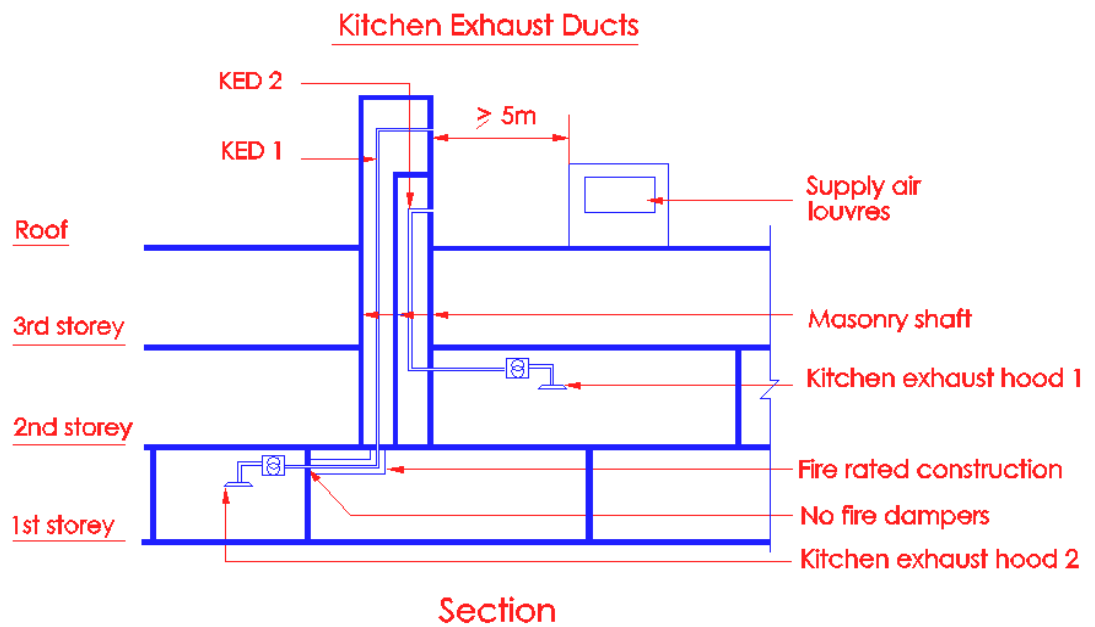
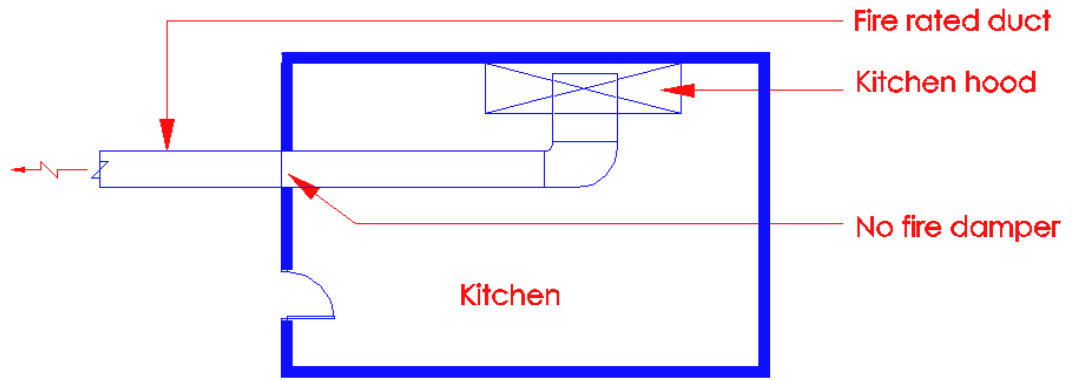

Diagram 7.1.7(a) – 1



Plan

Diagram 7.1.7(a)-2

Horizontal run of the exhaust duct outside the kitchen shall be fire rated with minimum 1-hour fire resistance rating. The 1-hour fire resistance shall be applicable to the inside and outside of the duct. The capacity of exhaust fan shall be in accordance with CP 13.

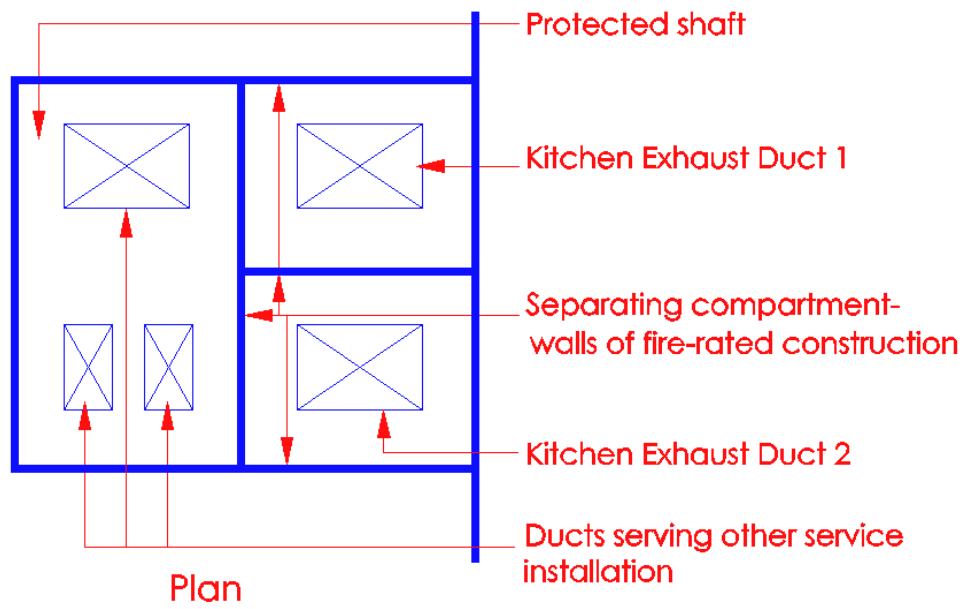

Plan

Diagram 7.1.7(a)-3

The protecting structure for protected shaft containing kitchen exhaust duct that pass through more than one or more floors shall be of masonry construction.

To eliminate the risk of fire spreading from one compartment to another through burning grease within the duct system, a separate exhaust system is required for each hood located in separate compartments.

Fire dampers are not permitted within the duct system. The effectiveness of fire dampers is questionable as accumulation of grease would jam the operation of the fire damper and the grease on the downstream side would likely ignite before the fire damper closes. There is also the possibility of false operation and closure other than in a fire situation that could have serious consequences.

In any case, the continued running of the exhaust system during a fire involving the cooking equipment or in the compartment would not aggravate the situation.

7.1.8 Rooms involving use of Flammable and Explosive Substances

- (a) Mechanical ventilation system where required for rooms which involve the use of flammable and explosive substances shall be independent from those serving other parts of the building. It shall comply with the following requirements:
 - (i) Ventilation system shall consist of exhaust and supply part with a rate of 20 air-change per hour or any other rates acceptable to the Relevant Authority. The exhaust shall be direct to the external and shall not be less than 5m from any air intake openings;
 - (ii) Where such ducts run outside the room they shall either be enclosed in a structure or be constructed to give at least the same fire rating as the room which they serve or that of the room through which they traverse, whichever is higher. The rating shall apply to fire exposure from both internal and external of the duct or structure. Where the duct risers are required to be enclosed in a protected shaft, constructed masonry or dry wall complying with Cl. 3.8.9(a), they shall be compartmented from the rest of the shaft space containing other ducts or services installations;
 - (iii) No fire damper shall be fitted in either supply or exhaust duct required under this Clause; and
 - (iv) Duct serving other areas shall not pass through rooms involving use of flammable and explosive substances.

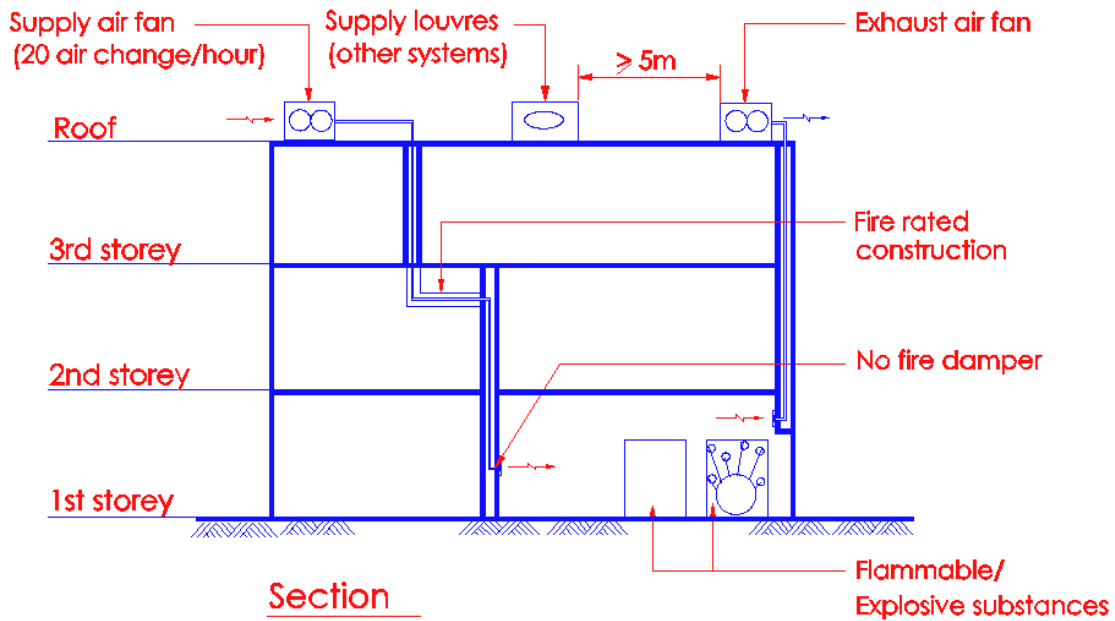

Diagram 7.1.8-1

The exhaust system (without fire damper) is required to operate efficiently to remove any gaseous or flammable vapour from the room.

Flammable/explosive materials shall not be kept or stored in the building. Small quantity of diesel oil (700 litres) would be permissible in generator room. The following requirements are applicable :

- (a) Where the flammable vapour being removed is heavier than air,
 - (i) at least one air outlet shall be located at a point near a wall, and no higher than 300mm from the floor, and
 - (ii) at least one air inlet shall be located near the opposite wall, no lower than 300mm from the ceiling.
- (b) Where the flammable vapour being removed is lighter than air,
 - (i) at least one air inlet shall be located at a point near a wall, and no higher than 300mm from the floor, and
 - (ii) at least one air outlet shall be located near the opposite wall, no lower than 300mm from the ceiling.

Room with flammable vapour
being removed is heavier than air

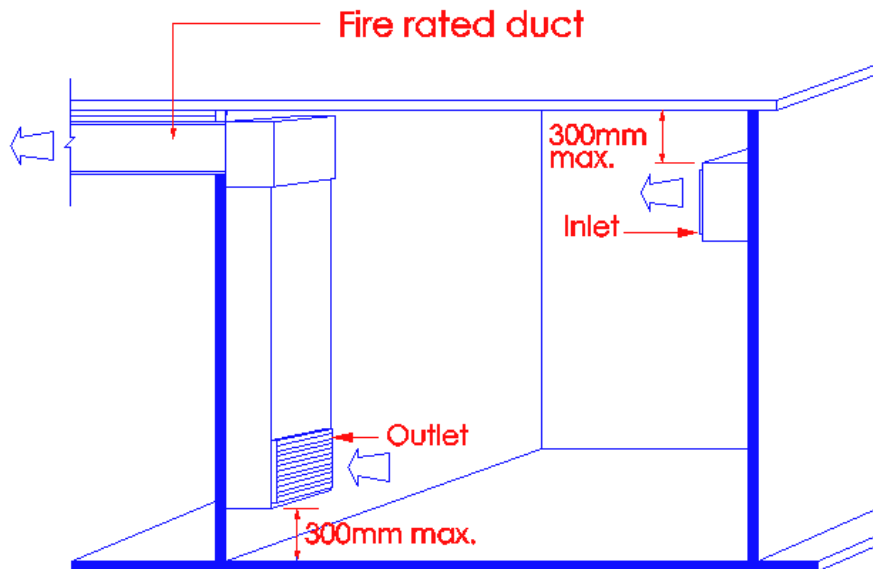

The flammable vapour is heavier than the air will be discharged via the exhaust system (without damper) as shown above.

7.2 PRESSURISATION FOR EXIT STAIRCASES

7.2.1 General

- (a) In any building of which the habitable height exceeds 24m, any internal exit staircases without provision for natural ventilation shall be pressurised to comply with the requirements in this Code
- (b) In a building comprising more than 4 basement storeys, exit staircase connected to fire fighting lobby in basement storeys shall be pressurised to comply with the requirements in this Code.
- (c) Pressurisation may be extended to smoke-stop lobby provided the pressurisation level complies with Cl.7.2.2(b).

Buildings exceeding 24m in habitable height

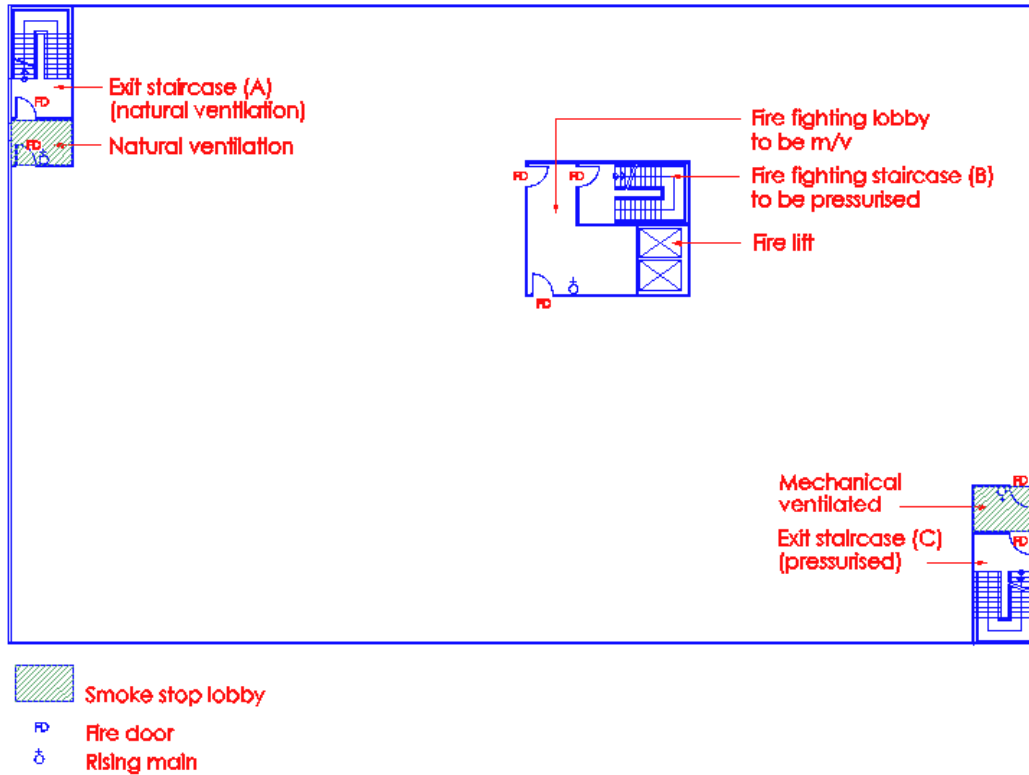

Diagram 7.2.1-1

Exit staircase (B) is pressurised as it is located within the floor space where natural ventilation can not be provided. Exit staircase (C), which is designed without provision for natural ventilation is pressurised.

Notwithstanding clause 2.2.13(c), smoke stop lobby is required to be provided to all internal staircases, without provision for natural ventilation, serving building exceeding the habitable height of 24m.

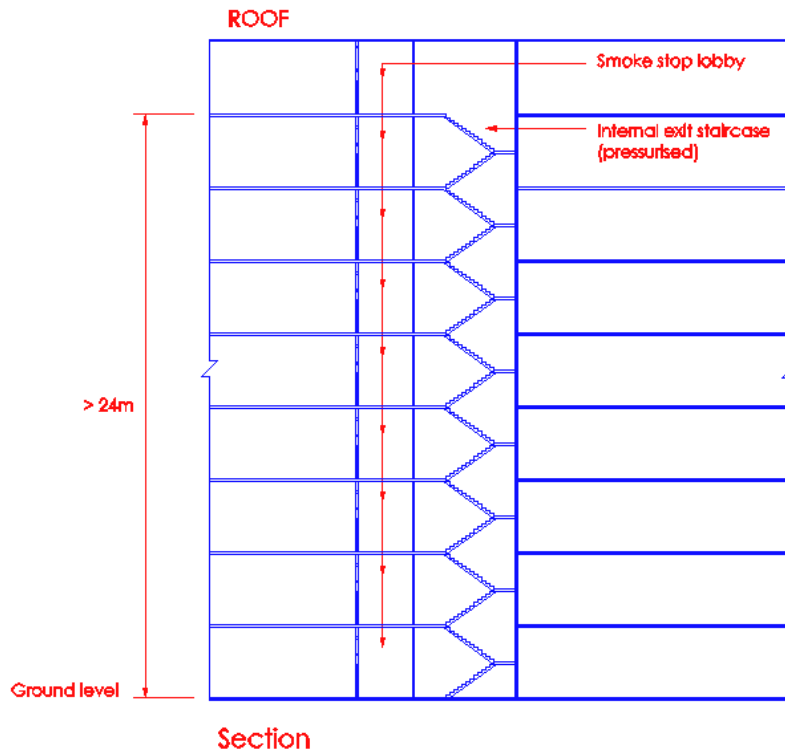

Diagram 7.2.1- 2

The above clause specifies that all internal staircases without provision for natural ventilation of building having more than 24m in habitable height, shall be provided with pressurisation notwithstanding that smoke stop lobby is provided. Smoke stop lobby if mechanically ventilated is to be provided with supply air of at least 10 air change per hour during fire mode. There shall be no exhaust duct extracting air out from the smoke stop lobby.

The need of a dedicated pressurisation system for each exit staircase is to prevent failure of one system affecting all exits. Air supply to the exit staircase must be obtained from outside the building to minimise the risk of contamination from smoke resulting from a fire in the building.

Ductwork associated with the discharge of air throughout the staircase may be located within the staircase itself, otherwise it must be protected in a masonry shaft.

To achieve the required air flow velocity on any storey, air supplied by the system should be evenly distributed throughout the height of the staircase by ductwork with outlets not located more than two storeys apart. Relief air grilles (pressure relief dampers) could be used for pressure control thereby minimising periods of excessive force to open doors of the staircases. Variable speed fans with pressure relief damper can be accepted as alternative arrangement.

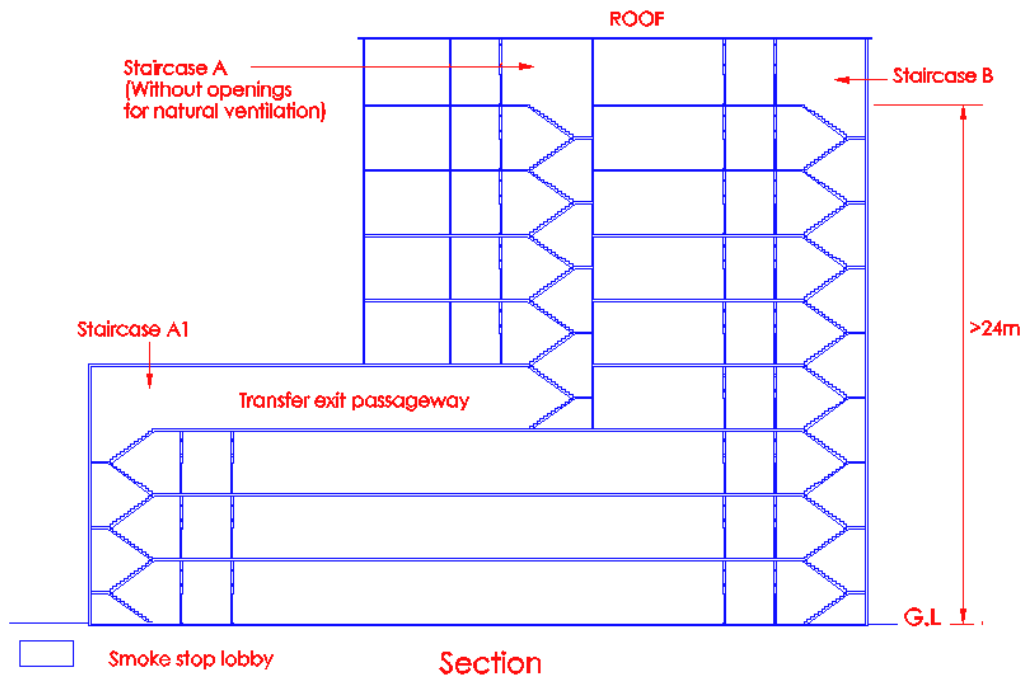

Diagram 7.2.1-3

Staircase A and transfer staircase A1 is considered as one single staircase sharing a common protected shaft. As staircase A is an internal staircase without openings for natural ventilation, exceeding a habitable height of 24m, it is required to be provided with M/V and pressurisation. Since, staircase A1 is acting as a transfer staircase, it shall likewise be M/V and pressurised notwithstanding the fact it can be naturally ventilated through external openings. The transfer exit passageway, which connects staircases A and A1, should also be M/V and pressurised. It is not acceptable to have partial pressurisation to staircase A by introducing a door across the transfer passageway, such that staircase A1 is separated for the provision of natural ventilation. The reason is that by providing a door across the transfer passageway, it would impede the movement of occupants moving towards staircase A1. In this way, the evacuation process within the whole shaft of staircase A would be slowed down.

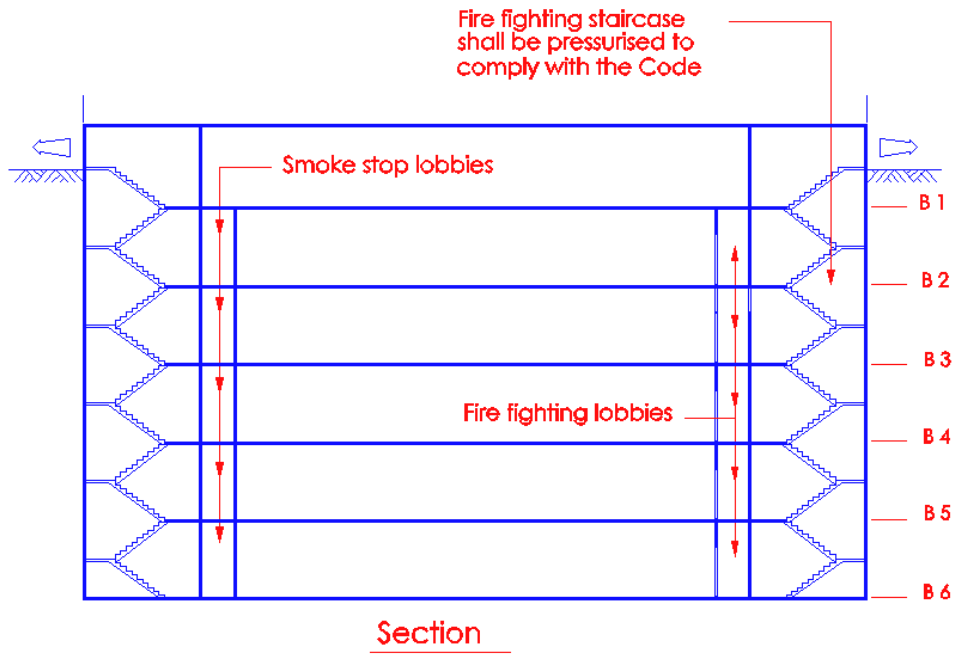

Diagram 7.2.1- 4

In a building comprising more than 4 basement storeys, the exit staircase designated as fire fighting staircase shall be pressurised.

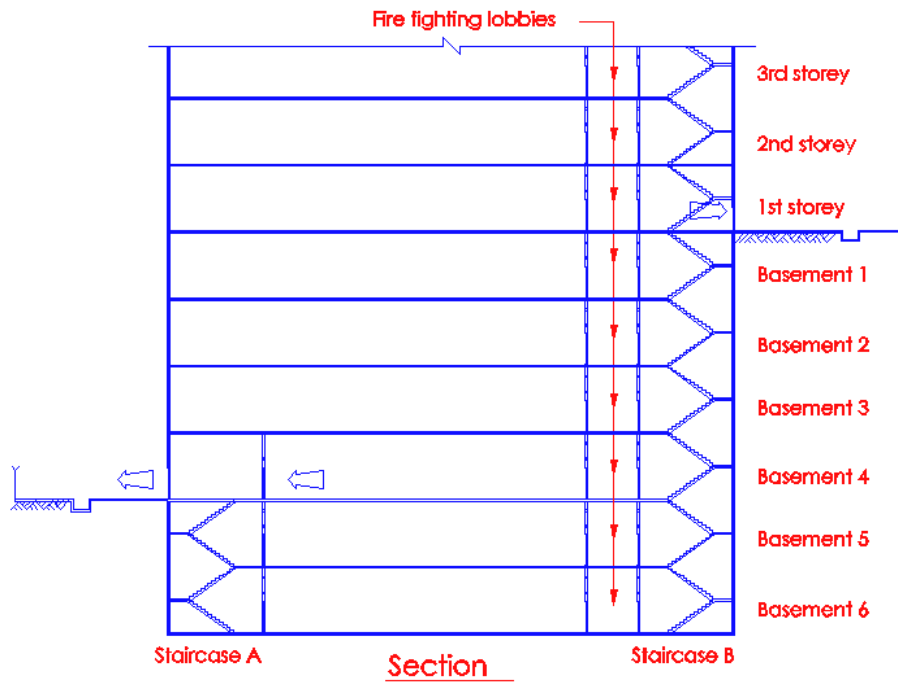

Diagram 7.2.1-5

Owing to the difference in ground levels, staircase B is serving more than 4 basements and is therefore designated as a fire fighting staircase complemented with a fire fighting lobby at each storey.

7.2.2 Pressurisation Level

- (a) When in operation, the pressurisation system shall maintain a pressure differential of not less than 50 pa between the pressurised exit staircase and the occupied area when all doors are closed.
- (b) Where a pressurisation system is extended to the smoke stop lobby, the pressure gradient shall be such that the pressure at the exit staircase shall always be higher.
- (c) The force required to open any door against the combined resistance of the pressurising air and the automatic door-closing mechanism shall not exceed 110 N at the door handle.

(a) Maintaining pressure differential

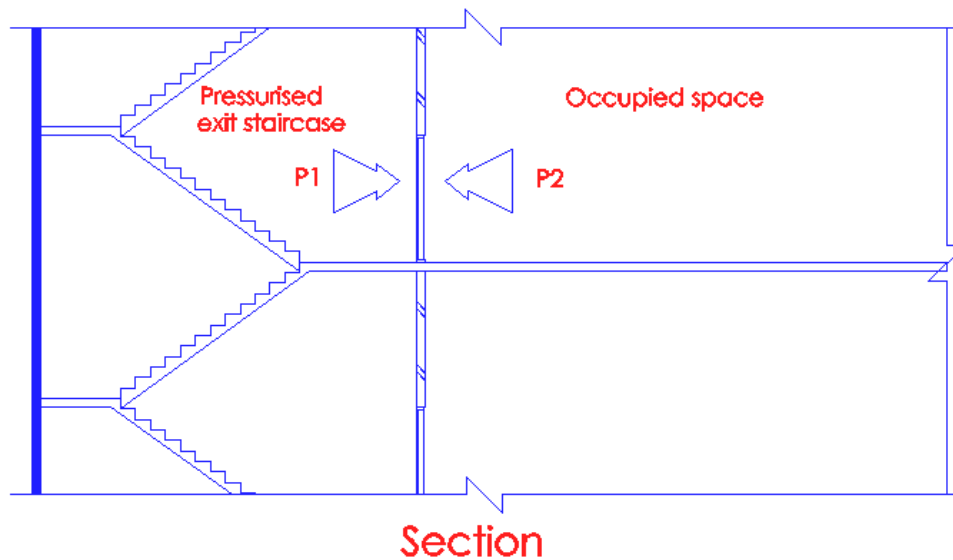

P1 = Pressurisation system pressure
P2 = occupied area pressure
 $P1 - P2 > 50 \text{ pa}$
Pressure P1 is greater than P2 in occupied space

Diagram 7.2.2(a)

(b) Pressure gradient

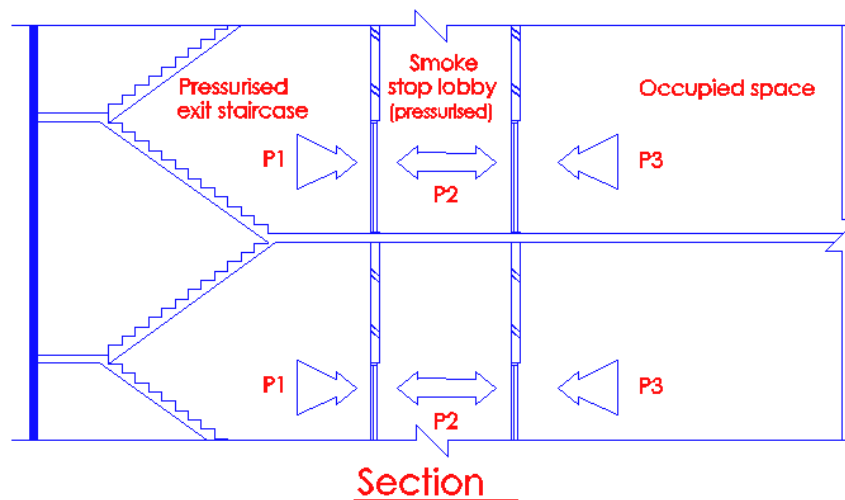

P1 = Pressurisation system pressure
 $P1 > P2 > P3$
 $P1 - P3 > 50\text{pa}$
 Pressure P1 in staircase is greater than pressure P2 in smoke stop lobby,
 P2 is greater than pressure P3 of occupied space

Diagram 7.2.2(b)

Where the smoke stop lobby is pressurised, the pressure gradient shall be such that the pressure at the exit staircase is always higher.

(c) Force required to open door

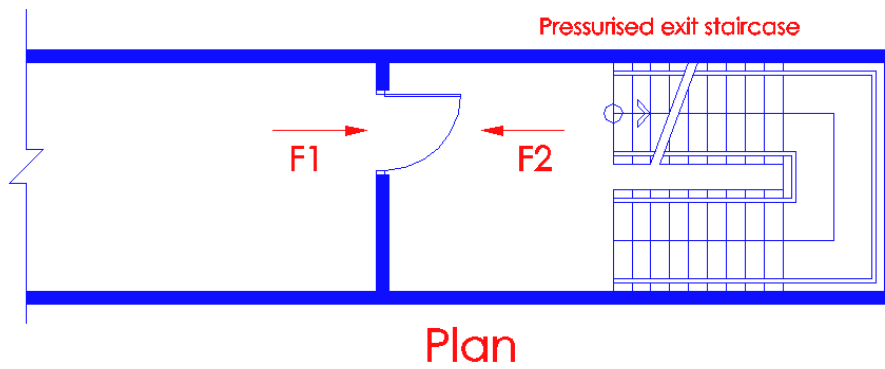

F1 = Force to open door
 F2 = Pressurising force

Diagram 7.2.2(c)

Measurement of the force required to open a stair door can be simply carried out by using a force-measuring in the push or pull mode eg. a spring balance. The maximum force permitted to open a door in accordance with this Code is 110 N. This equates to a force of 11.2 kilograms.

Lever operated latch sets are probably the easiest to measure. Simply hook the spring balance over the lever handle and depress same to unlatch the door, whilst taking care not to exert any push/pull force in doing so. To take a reading, slowly and steadily pull the spring balance and read the scale as the door just starts to open.

7.2.3 Egress velocity

When in operation, the pressurisation system shall maintain an airflow of sufficient velocity through open doors to prevent smoke from entering into the pressurised area. The flow velocity shall be attained when a combination of two doors from any two successive storeys and the main discharge door are fully open. Magnitude of the velocity averaged over the full area of each door opening shall not be less than 1.0m/s.

Air flow velocity through open door to prevent smoke from entering into the pressurised staircase

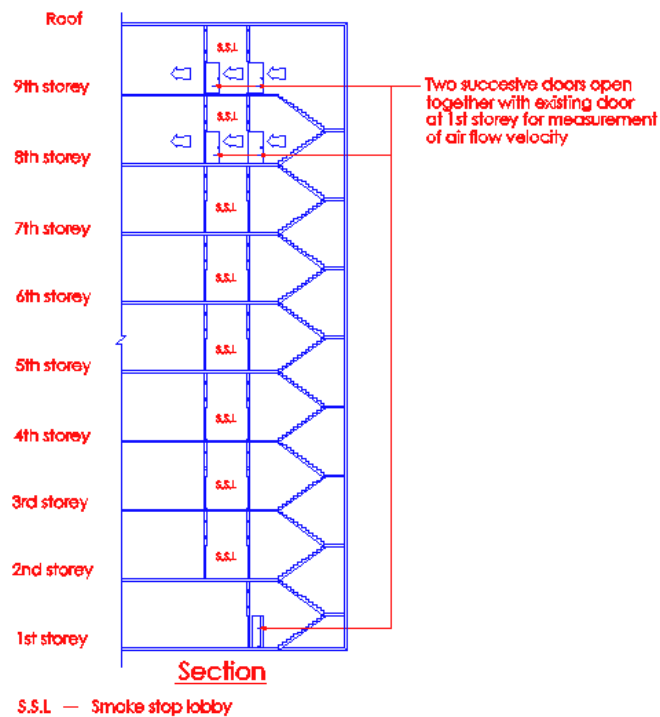

Diagram 7.2.3-1

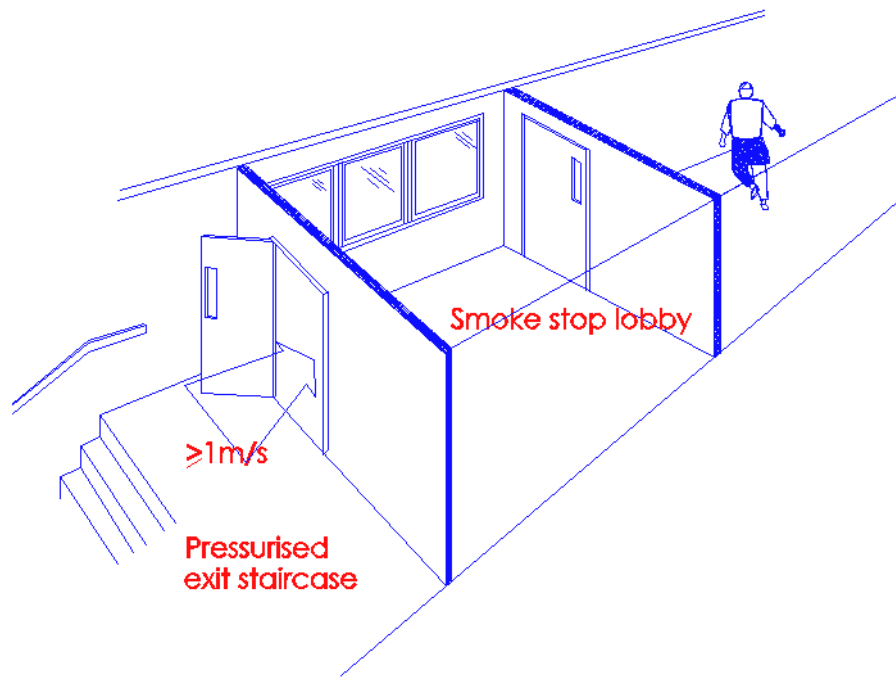

Diagram 7.2.3-2

The air flow velocity measurement through an open door of a pressurised staircase is taken from the entrance of any of two successive doors held open together with its exiting door at the 1st storey. The resulting value of its airflow velocity through the open door shall not be less than 1m/s.

Tests conducted by the Commonwealth Scientific and Industrial Research Organization (CSIRO) have demonstrated that air flows in excess of 0.8m/s through a door will minimise the spread of smoke against the direction of flow. A minimum air flow rate of 1m/s has therefore been adopted. This air flow must be maintained across the doorway providing egress from the fire-affected storey into the staircase during a fire. Initially, building occupants from both the fire floor and the floor above the fire floor will evacuate the building and, depending on the fire situation, this may be simultaneous operation.

The requirement for two floor doors and the 1st storey door (opening into the exterior) to be open the same time has two applications :

- (i) *When the fire fighters arrive and use the staircase for fire fighting operations, hose connection to the landing valves located on a floor would be carried out. Initially hose will be run from the floor below up the staircase and onto the fire floor hence a minimum opening of two doors is involved.*

- (ii) All required exit staircases must be usable at the same time as either fire fighters or evacuating occupants will be using any of them to exit at the 1st storey door to the street or external safe open area. Thus the final exit door would remain in the open position at all times.

7.2.4 Leakages

- (a) The rate of supply of pressurised air to the pressurised areas shall be sufficient to make up for the loss through leakages into the unpressurised surroundings.
- (b) Adequate relief of leaked air out of the occupied area shall be provided to avoid a pressure build-up in this area. The relief may be in the form of perimeter leakages or purpose-built extraction systems.

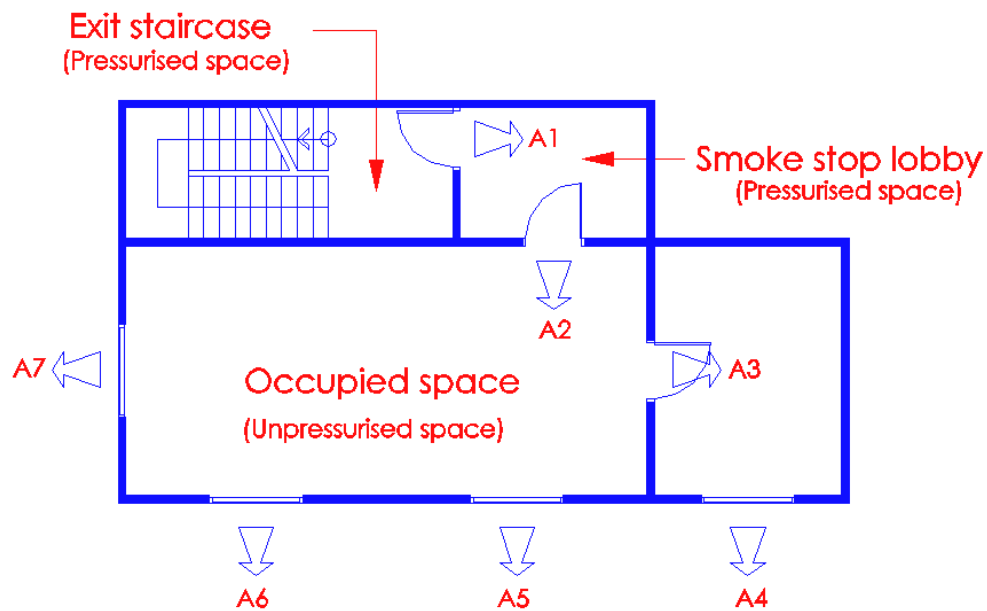

Diagram 7.2.4

Pressurised air could leak through areas such as gaps around doors, windows, other ventilation openings and other places where air will escape.

In the above diagram, pressurised air from the exit staircase leaks into the smoke stop lobby (A1) and occupancy areas (A2 & A3).

To avoid a pressure built-up in the occupancy area, adequate measures shall be taken to allow air leakage, e.g. thru windows A4 to A7. A pressure build-up would create difficult in opening the doors to the occupancy area.

The following are possible ways in which the escape of pressurizing air can be achieved:

- (a) by window leakage;

- (b) *by specially provided vents at the building periphery;*
- (c) *by the provision of vertical shaft;*
- (d) *by mechanically operated extraction.*

7.2.5 Distribution of Pressurising Air

- (a) The number and distribution of injection points for supply of pressurising air to the exit staircase should ensure an even pressure profile complying with Cl.7.2.2.
- (b) The arrangement of the injection points and the control of the pressurisation system shall be such that when opening of doors or other factors cause significant variations in pressure difference, condition in Cl.7.2.2 should be restored as soon as practicable.

Not Acceptable

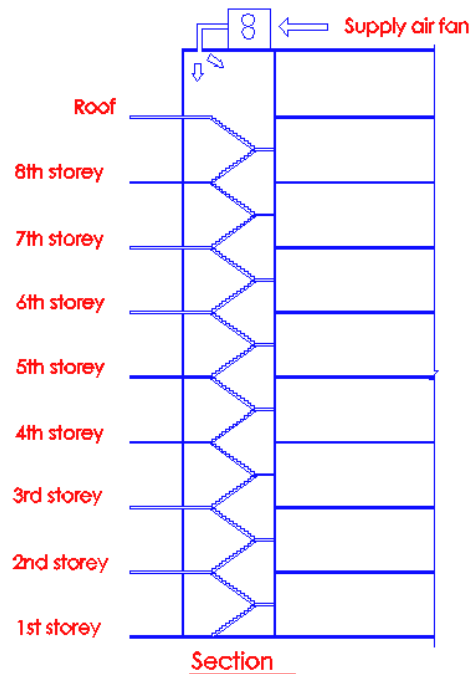

Diagram 7.2.5

The above installation is not acceptable as over pressurisation would occur at the upper portion of the staircase. Supply air to the staircase should be well distributed by a vertical supply duct, preferably serving all the levels of the staircase.

An example of an arrangement showing good distribution of supply air can be seen in diagram 7.2.6.

7.2.6 Equipment

- (a) All the equipment and the relevant controls associated with the pressurization system shall be so designed and installed to ensure satisfactory operation in the event of and during a fire.
- (b) Supply air for pressurization system shall be drawn directly from the external and its intake shall not be less than 5m from any exhaust discharge openings.

- (c) The pressurisation system shall be automatically activated by the building fire alarm system. In addition, a remote manual start-stop switch shall be made available to firemen at the fire command centre, or at the fire indicating board where there is no fire command centre. Visual indication of the operation status of the pressurisation system shall be provided.

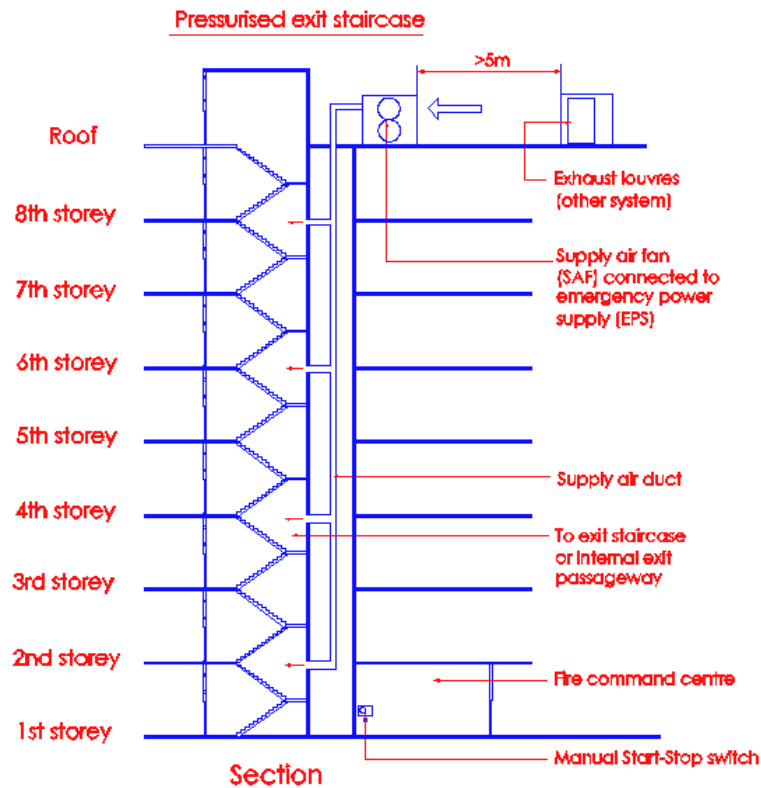

Diagram 7.2.6

The "start-stop" switch is required to be provided in the Fire Command Centre, or FIB where there is no FCC. The rationale is to provide the fire fighters greater ease and better control in operating the supply air fan to the staircase.

This arrangement, facilitate the supply air fan to be shut from the designated remote "start-stop" location. The supply air fan can then be restarted anytime when required.

7.3 PRESSURISATION OF INTERNAL CORRIDORS IN HOTELS

7.3.1 Pressurisation of internal corridors in hotels

Where internal corridors in hotels are required to be pressurised in compliance with Cl. 2.7.1(c), the pressure within such corridors shall be higher than that in the guest rooms and the pressure within the internal exit staircases higher than that of the corridors.

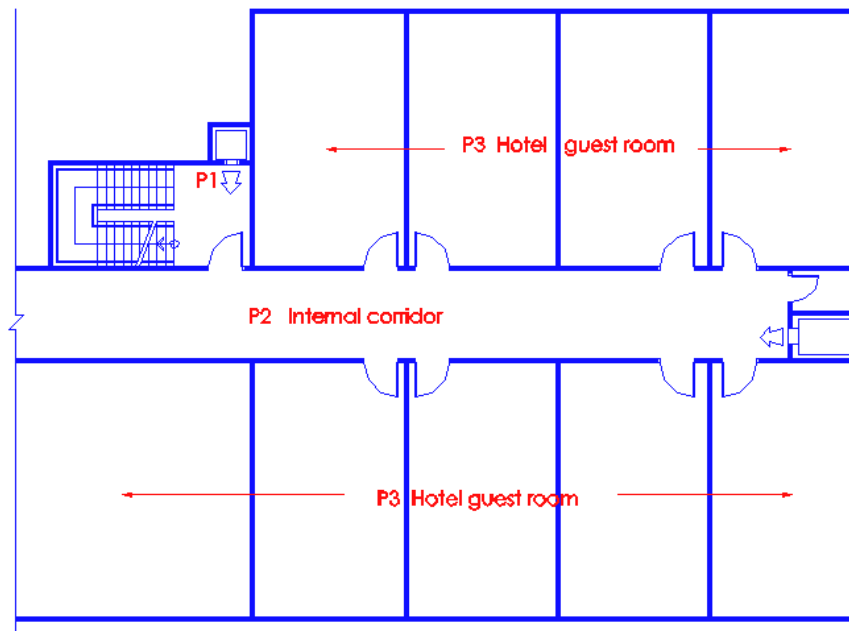

Diagram 7.3.1

Provision of pressurization to the internal corridor would help to check the migration of smoke from any of the guest rooms. The pressure gradient shall be such that :
 $P1 > P2 > P3$

Acceptable – Diagrams 7.3.1-2 to 7.3.1-6

More than 4 storey – (Internal staircase)

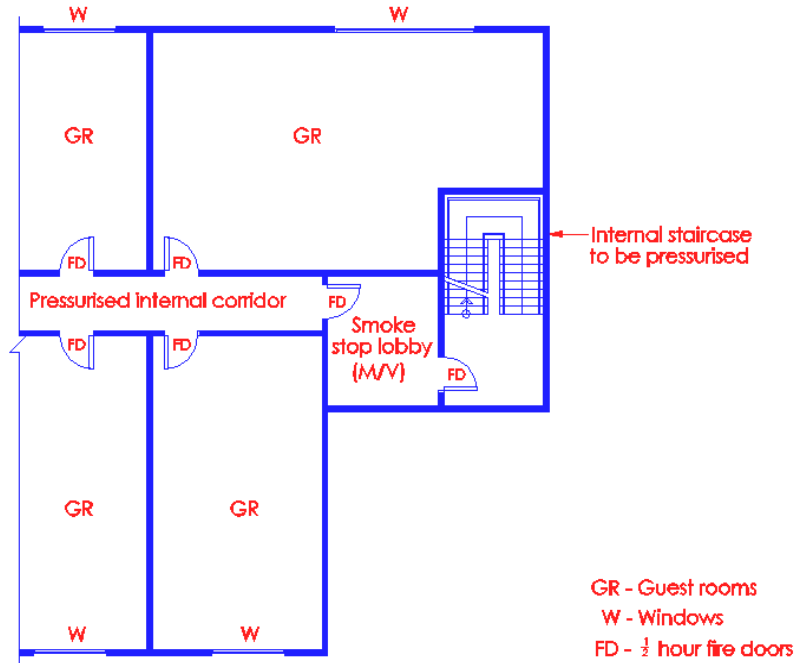

Diagram 7.3.1-2

The above diagram illustrates a mechanical ventilated smoke stop lobby and an internal staircase to be pressurised accordingly. The pressure gradient shall be such that the pressure at the exit staircase shall always be higher.

More than 4 storey – (External staircase)

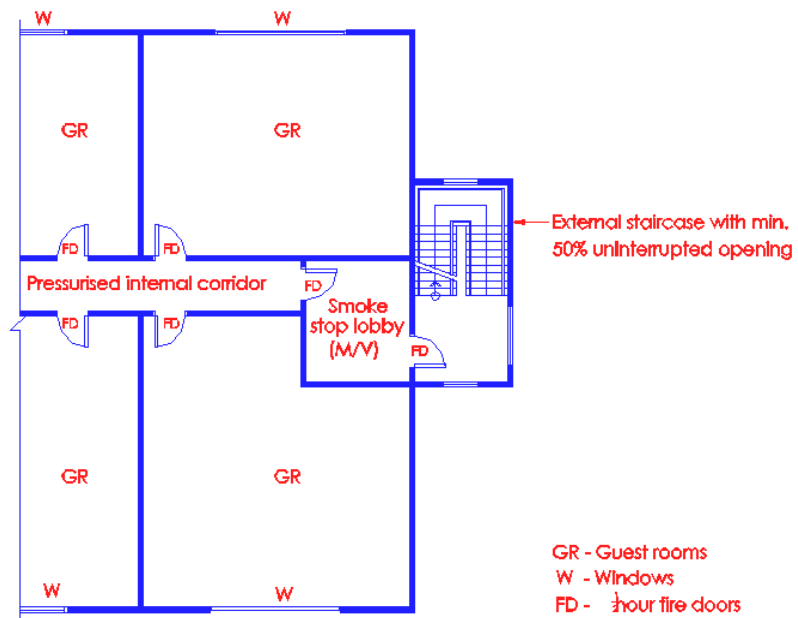

Diagram 7.3.1 – 3

The smoke stop lobby shall be provided with mechanical ventilation and the staircase shall be treated as an external staircase. The external staircase shall be provided with uninterrupted openings having minimum 50% of the staircase plan area.

More than 4 storey – (External staircase)

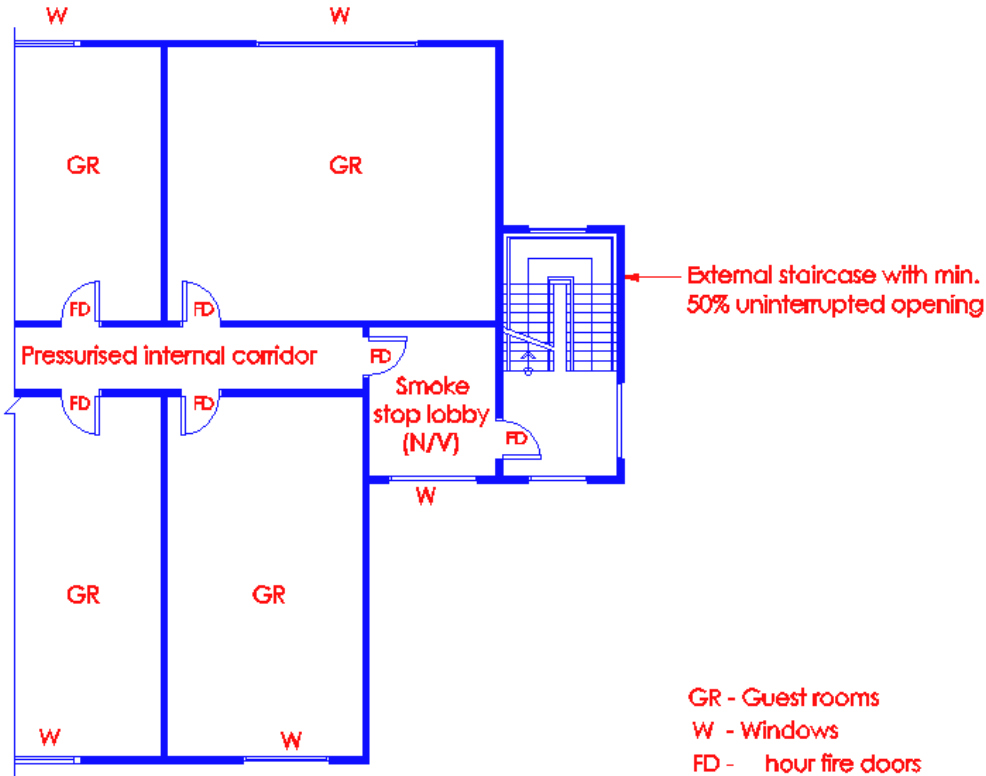

Diagram 7.3.1-4

The above diagram illustrates a naturally ventilated smoke stop lobby and external staircase. The smoke stop lobby shall be provided with minimum 15% external openings. The external staircase shall be provided with uninterrupted openings having minimum 50% of the staircase plan area.

Not more than 4 storey – (External staircase)

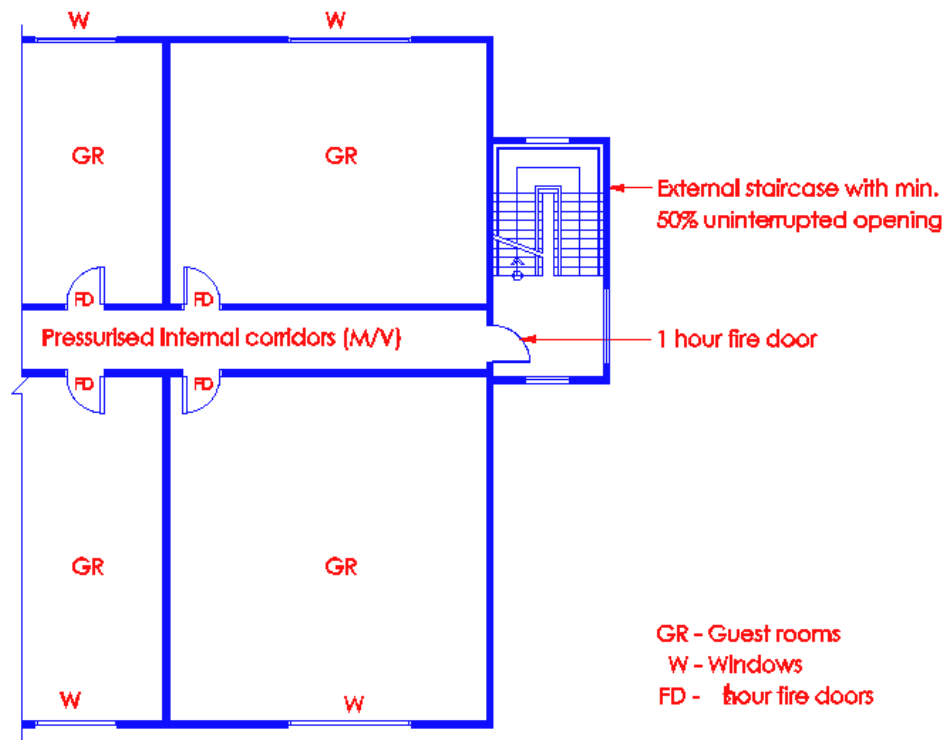

Diagram 7.3.1-5

The internal corridor leading to the exit should be via a minimum 1 hour fire resistance door. The external staircase shall be provided with uninterrupted openings having 50% of the staircase plan area.

Not more than 4 storey – (Internal staircase)

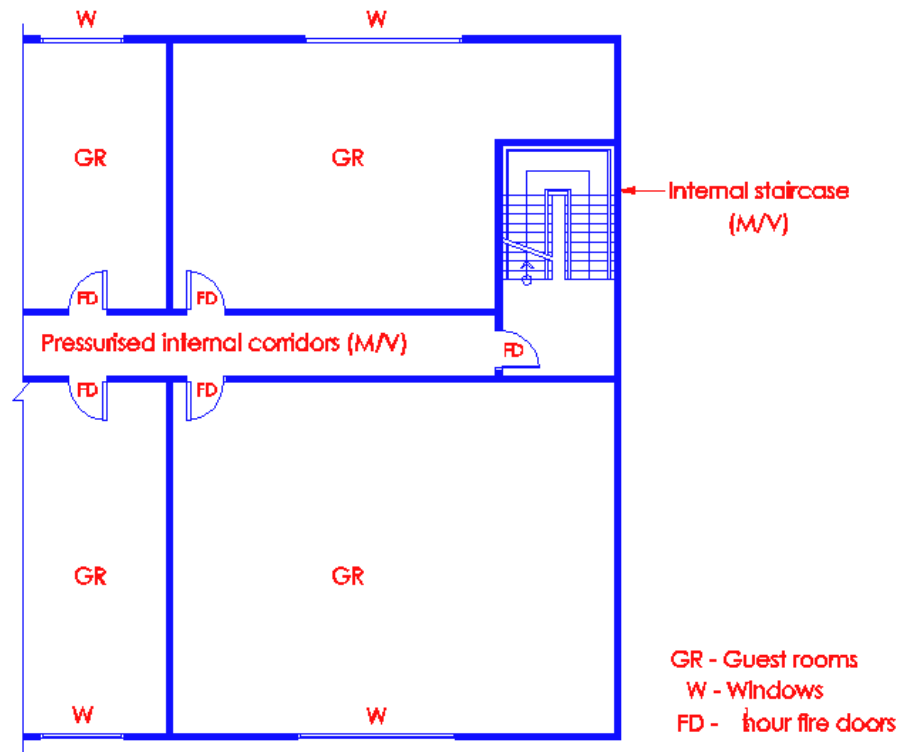

Diagram 7.3.1- 6

In the above diagram, the provision of smoke stop lobby is not required by virtue of its height under cl. 2.2.13. The staircase is an internal staircase, as such it shall be pressurised to have a higher pressure differential than the internal corridor.

Not more than 4 storey

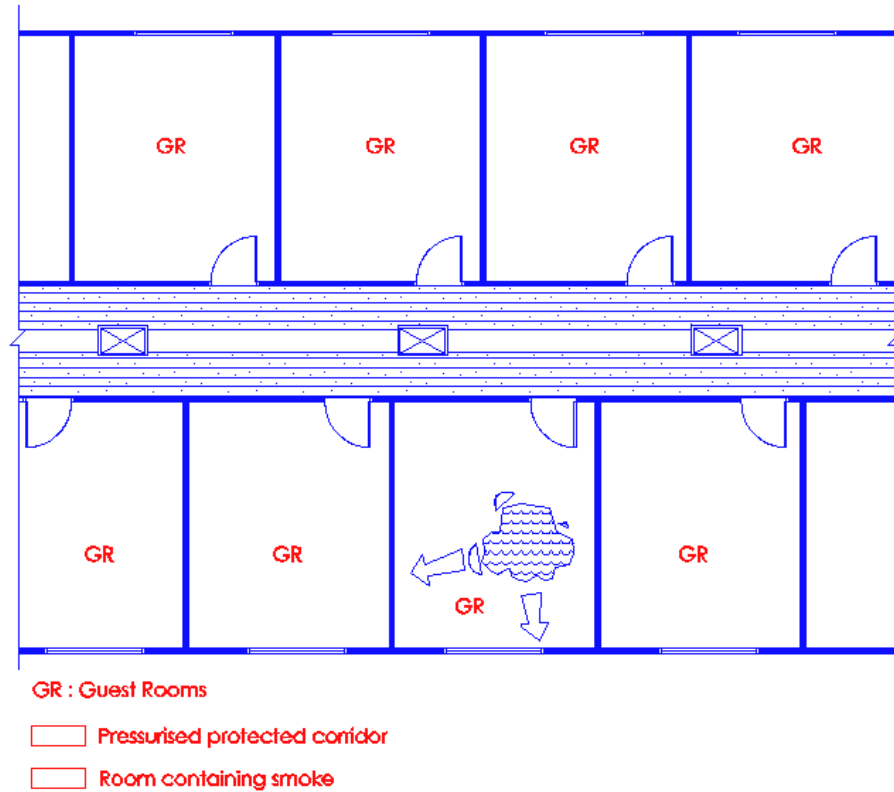

Diagram 7.3.1-7

The above diagram shows a simple pressurisation system suitable for small hotels. It consists of fans, which are connected to smoke sensitive device so that they operate in fire emergency. The corridor shall be provided with pressurisation to maintain a positive pressure. The power and capacity of the fan is calculated after evaluation of air leakage factors, so that an adequate pressure differential can be developed between the corridor and the guestrooms.

For effective pressurisation, there must be sufficient leakage through the external envelope of the building so that the pressure in the fire room will not reach the same pressure level with the pressure in the protected corridor.

For rooms, including guestrooms without external windows, automatic vent to reduce the pressure build up within the rooms must be provided.

7.4 BASEMENT SMOKE CONTROL SYSTEM

7.4.1 Scope

- (a) Where the total aggregate floor area of all basement storeys does not exceed 1900sq m, smoke vents in accordance with Cl.7.4.2 shall be provided.

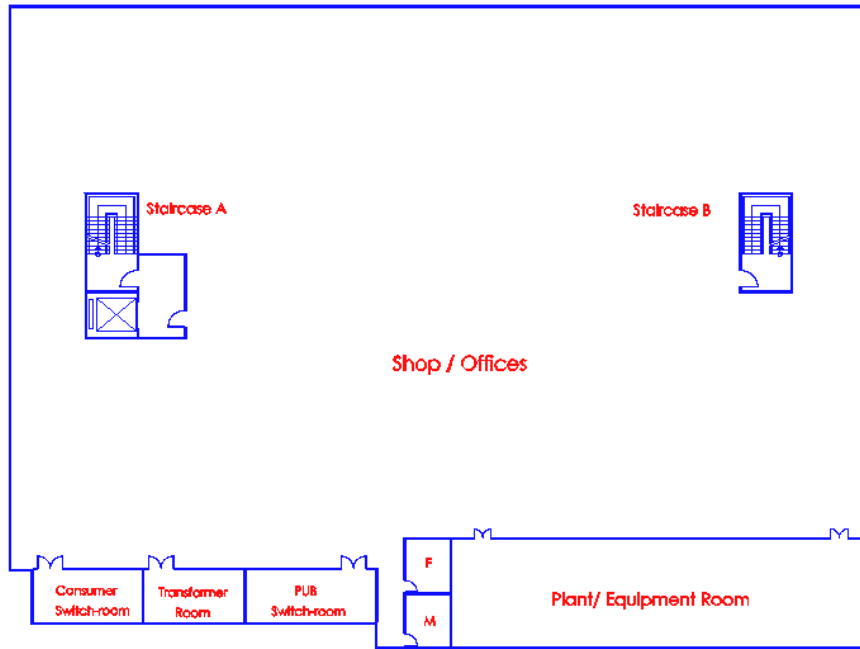

Basement 1

Diagram 7.4.1(a)-1

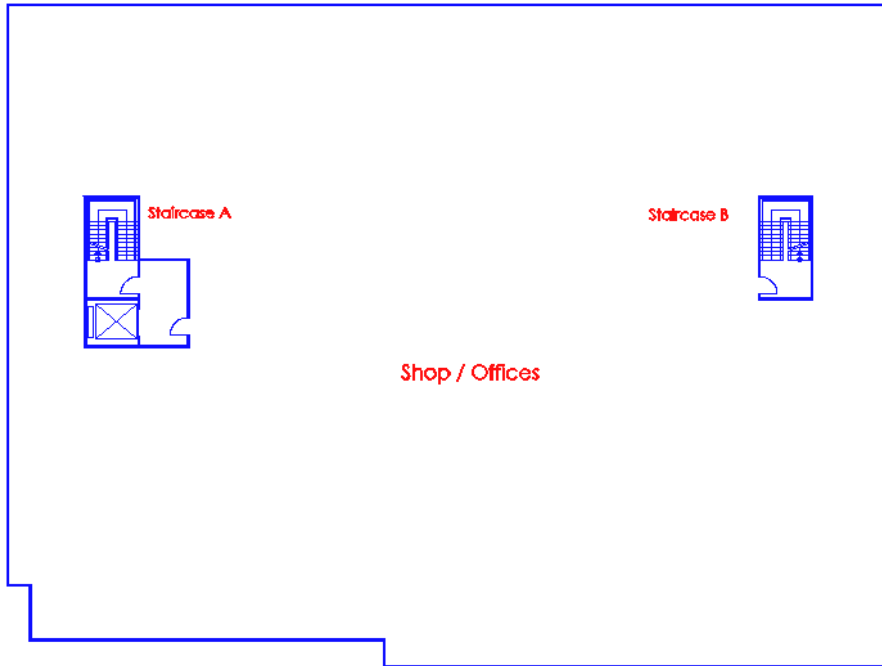

Basement 2

Diagram 7.4.1(a)-2

Total aggregate floor area of basement storeys = Area of shop/offices Basement 1 & 2 + staircases + services area (TAS, Transformer room etc) + plant/equipment room of basement 1.

- If total aggregate area $<1900\text{m}^2$ (smoke vents shall be provided - see clause 7.4.2).

If total aggregate area $>1900\text{m}^2$ (engineered smoke control system is required). See also clauses 7.4.1(b)(ii) & (iii).

- (b) Where the total aggregate floor area of all basement storeys exceeds 1900sq m , engineered smoke control system that complies with the requirements stipulated in Cl.7.4.3 shall be provided for all parts of basement with the following exceptions:

- (i) Exception

Where the basement or a portion of the basement is used as carpark, Cl.7.1.9 can be adopted to the carpark provided it is compartmented from rest of the basement;

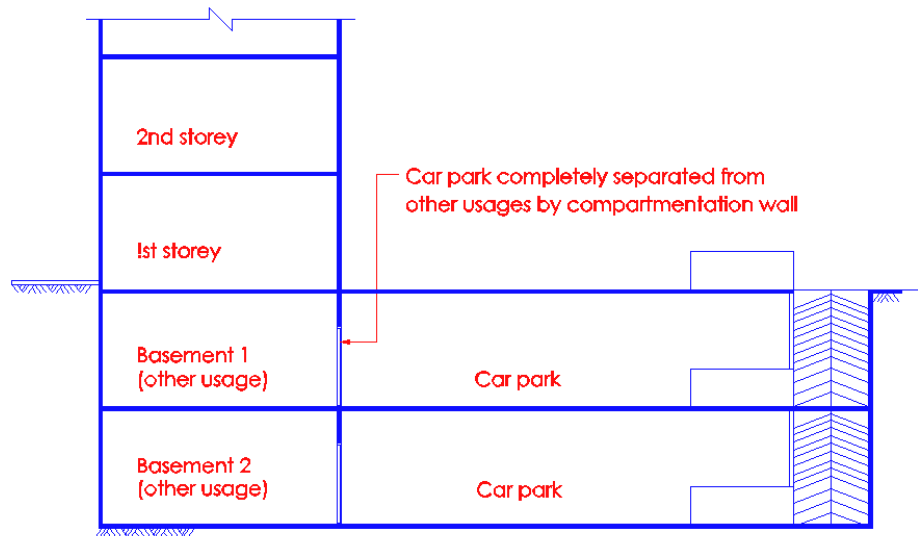
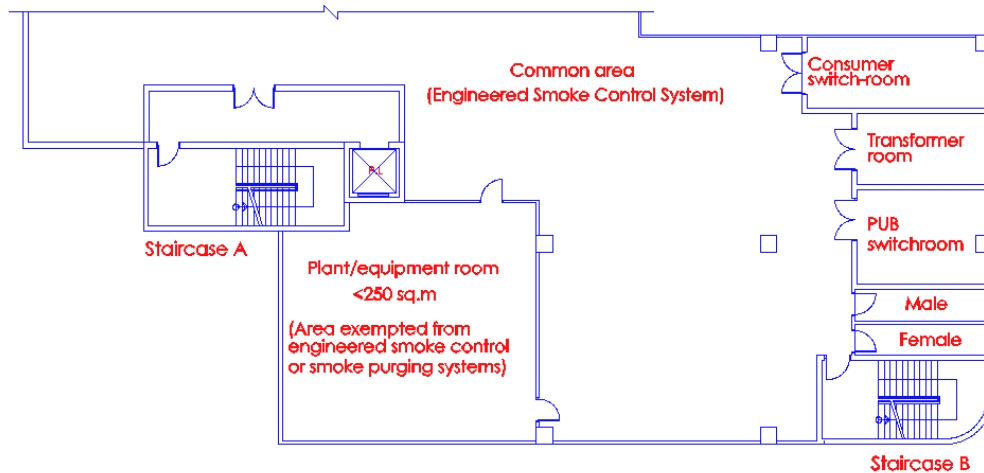

Diagram 7.4.1(b)(i)

If the total floor area of basements 1 & 2 (other usage + car park) $>1900\text{m}^2$, engineered smoke control is required to be provided in the basement storeys; except the car parking areas in basements 1 & 2 which need to be provided with smoke purging system under clause 7.1.9.

- (ii) Plant/equipment room with floor area not exceeding 250sq m and compartmented from rest of the basement, and provided with two doors for better reach in fire fighting operation.



Part plan of basement storey

Diagram 7.4.1 (b) (ii)

Where the plant/equipment room is not greater than 250m^2 , fire fighters can fight a fire in that room from its doorway. If the plant/equipment room is not larger than 100m^2 , one access door would be considered acceptable.

- (iii) Plant/equipment room with floor area exceeding 250sq m but not exceeding 1900sq m , smoke vents in accordance with cl.7.4.2 or smoke purging system of at least 9 air-change per hour shall be provided.

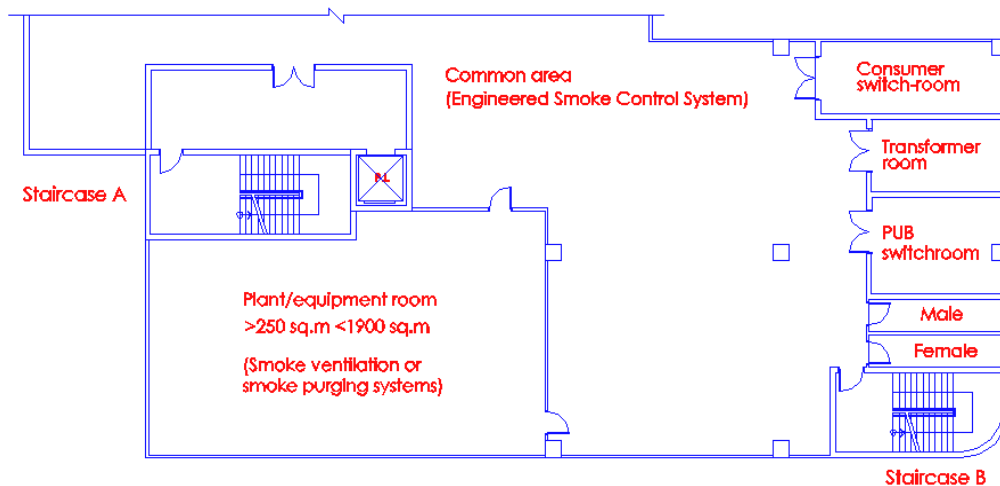

Part plan of basement storey

Diagram 7.4.1 (b) (iii)

Where floor area of the plant/equipment room is in excess of 250m², but not exceeding 1900m², provision of smoke vents in accordance to Cl.7.4.2 or smoke purging system in accordance with Cl.7.1.9 would be acceptable. Also, for a plant room in excess of 1900m², the provision of either engineered smoke control system or smoke purging system is acceptable.

Subclause (iii) is meant to grant relaxation over the general requirement as service rooms are usually of low occupancy load. Common corridors serving multiple plant rooms/service rooms may be pressurised. Common areas outside the plant rooms/service rooms should be provided with engineered smoke control system.

- (iv) Service areas such as laundries, office, storeroom and workshops (restricted to staff only) which are compartmented, smoke venting provision in accordance with Cl.7.4.2 or smoke purging system of at least 9 air-change per hour may be acceptable for those areas in lieu of the engineered smoke control system, Automatic fire alarm/extinguishing system in accordance with table 6.4A shall be provided where required.

Basement Floor Plan

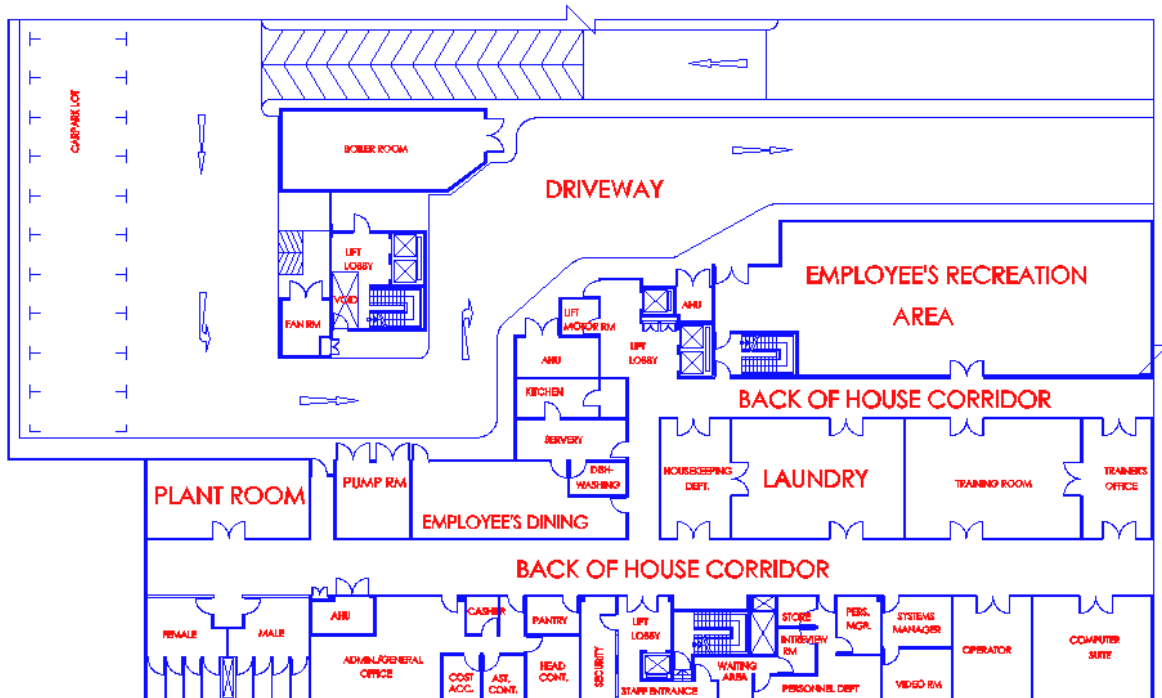

Diagram 7.4.1(iv)

The above clause is mainly applicable to hotel building. Service area such as laundries, offices, stores and workshops are restricted to staff only shall be compartmented. The total area of these compartments shall not exceed 1900m². (per storey basis) Each compartment shall be provided with smoke venting or smoke purging system.

7.4.2 Smoke vents

Smoke vents shall be adequately distributed along perimeter of basement and their outlets shall be easily accessible during fire fighting and rescue operations. Installation shall comply with the following requirements:

- (a) The number and their sizes shall be such that the aggregate effective vent openings shall not be less than 2-½ per cent of the basement floor area served.
- (b) The vent outlets if covered under normal conditions shall be openable in case of fire.
- (c) The position of all vent outlets and the areas they serve shall be suitably indicated adjacent to such outlets.
- (d) Where ducts are required to connect the vent to outlets, the ducts shall either be enclosed in structure or be constructed to give at least 1 hour fire resistance.
- (e) Separate ducts and vent outlets shall be provided for each basement storey.

Basement occupancies smoke vents

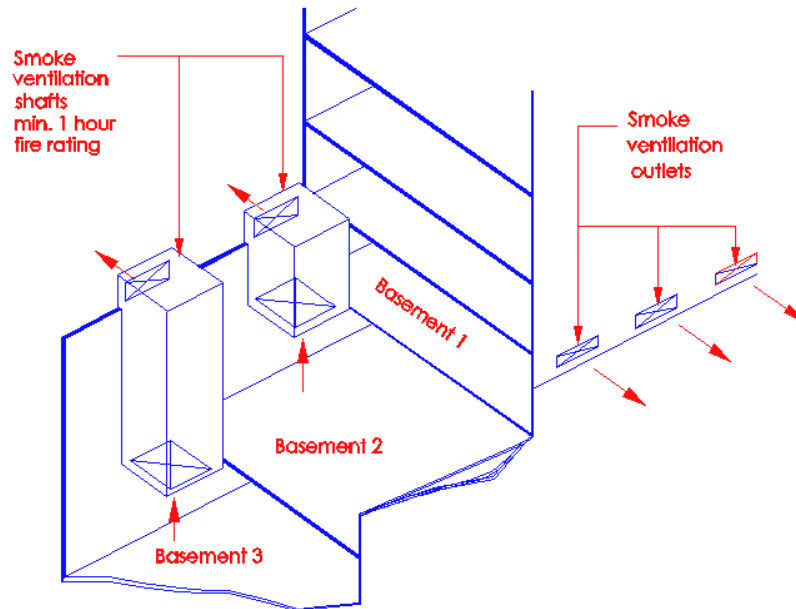

Diagram 7.4.2

- smoke ventilation shafts which are extended through storeys above, shall be enclosed with walls having minimum 1 hour fire resistance
- Separate smoke ventilation shafts and outlets shall be provided for each basement storey.
- Smoke venting outlets shall be so arranged that a through draught can be created. The outlets shall be evenly and strategically located so that they can serve the general spaces in the basement and not be hidden in rooms.
- Outlets covered by stalled boards, or approved type pavement lights shall be readily openable/breakable.
- The positions of all smoke vent outlets and the basement level or areas they serve shall be suitably indicated on the external face of the building adjacent to such outlets. Smoke vents and pavement glass blocks serving only one basement storey need not be indicated by signages.

7.4.3 Engineered smoke control

Where engineered smoke control system is required, it shall be provided as specified in Cl.7.6.

(See clause 7.6)

7.5 Smoke Control System

7.5.1 A smoke control system specified in Cl.7.6 shall be provided where:

- (i) The requirements for compartmentation specified in Cl. 3.2.1 and 3.2.4(a) and (b) are relaxed under the conditions in Cl. 3.2.6 for 'Atrium spaces' in a building; and
- (ii) The total floor area of any compartment in a building or part of a building exceeds 5000 sq.m.

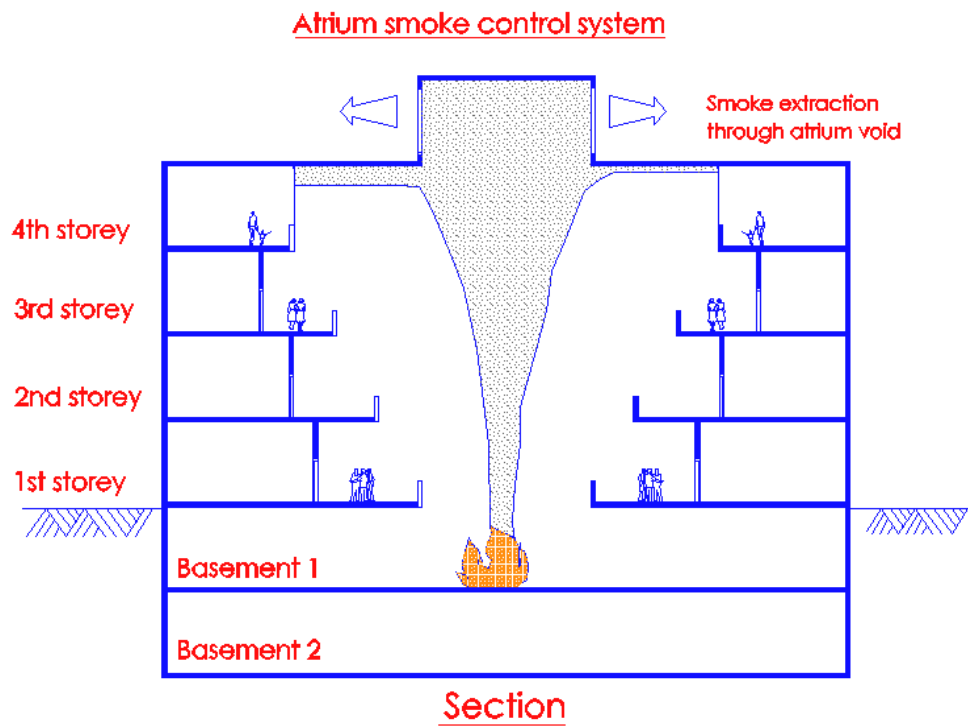

Diagram 7.5.1

Where the Relevant Authority is satisfied that the following relaxations can be allowed, an engineered smoke control system shall be provided :

- a) the compartment size having the floor area and cubical extent greater than as provided for under Table 3.2A;
- b) the compartment height of atrium is connecting more than 3 storeys below the habitable height of 24m;
- c) the compartment height of atrium is connecting more than single storey above the habitable height of 24m.

The Qualified persons should consult SCDF(FSSD) to seek consent before making any plan submission.

Where more than 3 storeys are interconnected and when the size is relaxed with the provision of atrium smoke control system, only the first basement is allowed to form part of the upper storey.

7.6 ENGINEERED SMOKE CONTROL SYSTEM

7.6.1 The engineered smoke control system shall be in the form of a smoke ventilation system by natural or mechanical extraction designed in accordance with:

- (a) BR 186 - Design principles for smoke ventilation in enclosed shopping centres; and
- (b) BR 258 - Design approaches for smoke control in atrium buildings; or
- (c) Other acceptable standards.

(Note: BR 186 and 258 are reports published by the Fire Research Station, Building Research Establishment, Borehamwood, Herts WD62BL).

(No illustration)

BR186 and BR258 and subsequent revisions/amendments have been adopted as acceptable design guides for engineering smoke control systems. Other acceptable standards such as NFPA 92A may be adopted, taking into consideration that the basic requirements of smoke control system in the Fire Code should be strictly complied with. In the case of differences in requirement between BR186/258 and NFPA 92A, e.g. classification of fire size, the clear height of smoke layer base, the Qualified Persons should consult FSB to determine which requirement to adopt before building plan submission. Other acceptable standards referred to from time to time will be evaluated and QPs will be informed through SCDF (FSSD's) circulars.

7.6.2 Sprinkler system

The building to be provided with smoke ventilation system shall be sprinkler protected.

(No illustration)

The main reason that sprinkler system must be provided is to help to control the fire size so that the amount of smoke generated could be kept in manageable size. The sprinkler head spacing in respect of both hazard and classification determines the size of a fire in terms of area and perimeter. The activation of sprinkler heads would, besides controlling the fire size, help to reduce the build-up of heat and flammable vapour, which can lead to flashover. Based on research, if the fire is not sprinkler controlled, the fire size could be unlimited and therefore, fire size could not be established.

7.6.3 Fire size

Capacity of the smoke ventilation system shall be calculated based on the incidence of a likely maximum fire size for a sprinkler controlled fire as recommended in the following table:

Occupancy (Sprinklered)	Fire Size	
	Heat Output (MW)	Perimeter of Fire (m)
Shops	5	12
Offices	1	14
Hotel Guest Room	0.5	6
Hotel Public Areas	2.5	12
Assembly Occupancy with fixed seating	2.5	12

(No illustration)

The above examples of fire sizes under sprinkler control fire are recommended by Fire Research Station.

7.6.4 Capacity of smoke ventilation system

The capacity of a smoke ventilation system shall be capable of handling the largest demand for smoke exhaust from the worst case scenario.

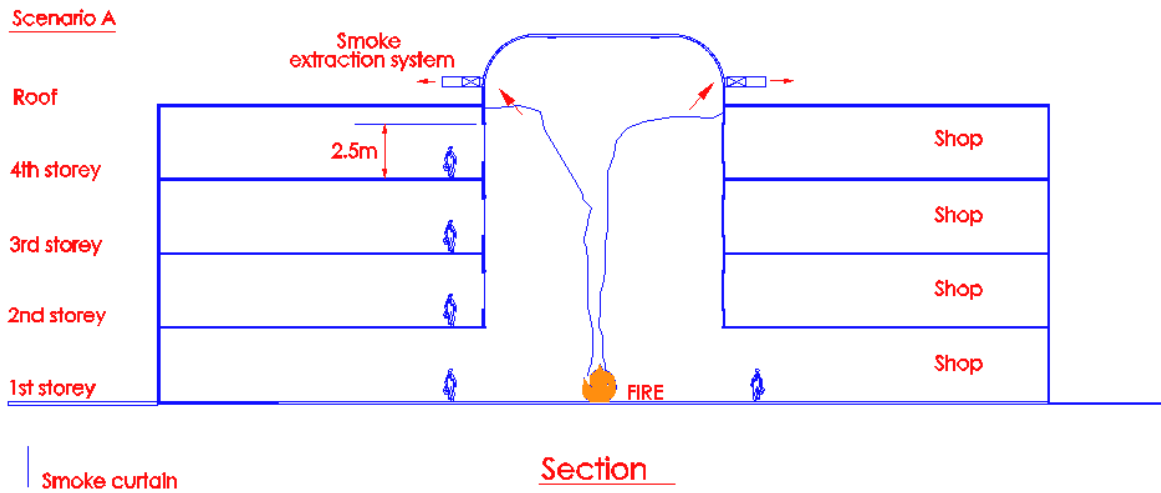

Diagram 7.6.4 - 1

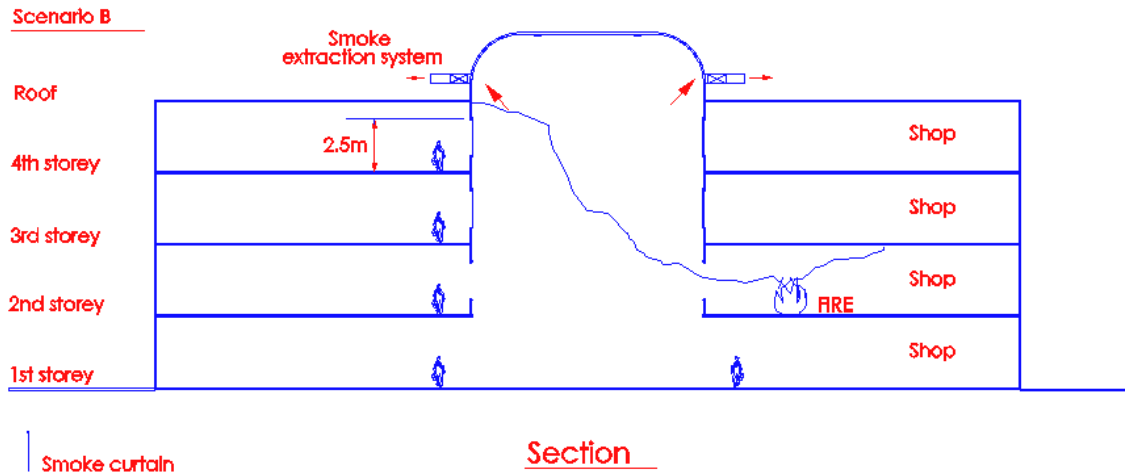

Diagram 7.6.4 - 2

The smoke generated from a fire at 2nd storey requires to travel two floors upwards to reach the smoke reservoir. The vertical smoke plume is shorter than a fire occupying at the atrium floor and therefore less entrainment of air.

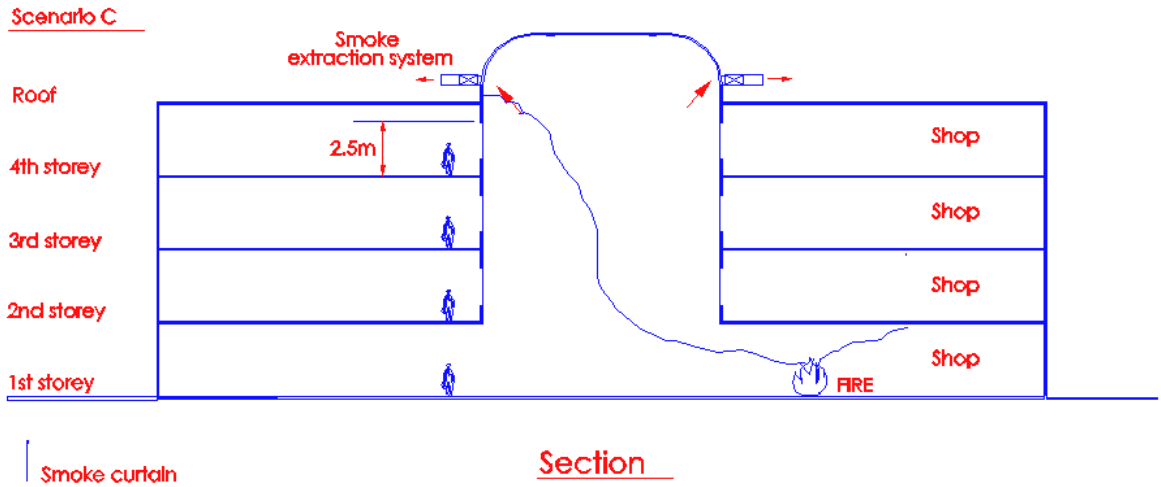

Diagram 7.6.4-3

The engineered smoke control system may be designed based on smoke control zones, provided the system is capable of handling the largest demand of smoke produced under the worst case scenario. The worst scenario would be scenario C where the fire size occurring at 1st storey as shown in the diagram above. As the smoke and hot gases rise through the upper levels, a very large quantity of smoke would be further generated through entrainment and greater cooling effect of smoke would occur.

7.6.5 Clear layer

The design smoke layer base shall be above the heads of people escaping beneath it. The minimum height shall be 2.5 m.

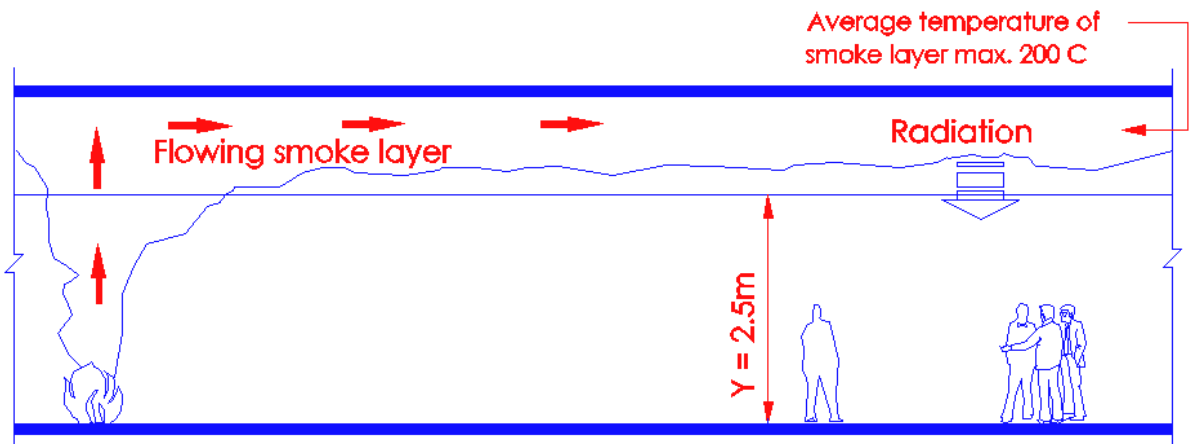

Diagram 7.6.5

The clear height below smoke layer (Y) = 2.5m minimum.

The main purpose is to permit occupants to evacuate in a clear breathable layer. The maintenance of this clear layer will aid the fire fighting operations. The lowest acceptable temperature of smoke layer to prevent loss of buoyancy is 18°C above ambient.

The radiation from the smoke layer which has temperature of more than 200°C may cause severe pain and discomfort to occupants escaping beneath it.

7.6.6 Smoke reservoir

Smoke reservoirs to prevent the lateral spread of smoke, and to collect smoke for removal shall be of non-combustible construction capable of withstanding smoke temperatures.

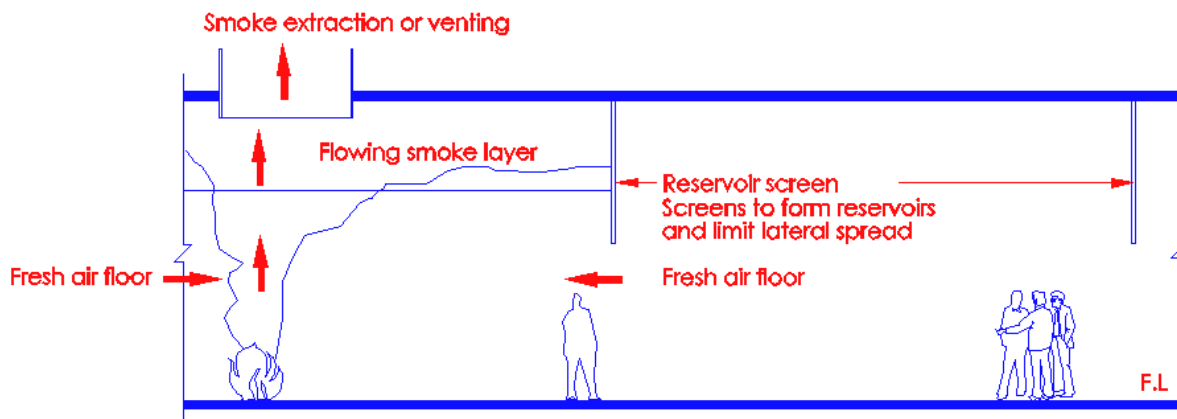

Diagram 7.6.6

Smoke reservoirs could be formed by using either the building's geometry or by using smoke curtains/shutters/non-combustible downstands, such as fire resisting boards, glazing. The screens, which extend downwards from the roof or ceiling to form the smoke reservoir, should be smoke tight. They should be resistant to the effects of the fire. The main reasons for restricting lateral spread of smoke by providing smoke reservoir are:

- a) to prevent smoke layer (because of mixing with cold air in the course of lateral travel) become relatively cool resulting in loss of buoyancy and lowering of smoke layer. This will result in roof vents being unable to expel the smoke efficiently. Smoke vents would be most effective if the temperature of the smoke layer is high and that the layer beneath the vent is quite deep, thus developing a reasonable pressure differential to act to expel the smoke through the vent; and
- b) to prevent damage or even ignition to combustible parts of ceiling lining or service components if hot smoke layers are allowed to spread uncontrolled over unlimited areas.

7.6.7 For cases where smoke is removed from the room of origin the smoke reservoir size for a smoke ventilation system shall not exceed:

- (a) 2000 sq m for natural smoke ventilation system.
- (b) 2600 sq m for mechanical smoke ventilation system.

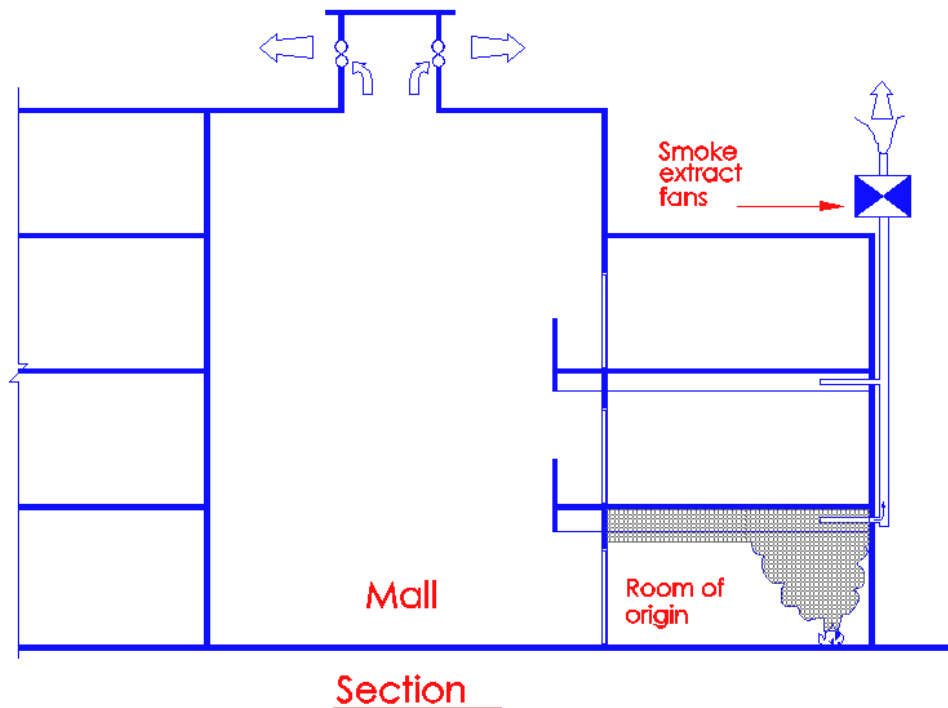

Diagram 7.6.7

Rooms of origin includes large shopping floor, rooms or spaces. In order to prevent excessive heat loss, the size of an individual smoke reservoir should not exceed the prescribed size. In the above diagram, the shop fronting the mall is provided with its own smoke control system. The reason for this is that if the smoke fills the large shop before entering the mall, then considerable cooling could have taken place making the smoke too cool to be disposed of by the smoke venting or extraction system. The result would be low-level smoking logging in the mall.

7.6.8 Removal of smoke from circulation or atrium spaces

For cases where smoke is removed from the circulation space or atrium space the smoke reservoir size for a smoke ventilation system shall not exceed :

- (a) 1000 sq m for natural smoke ventilation system.
- (b) 1300 sq m for mechanical smoke ventilation system.

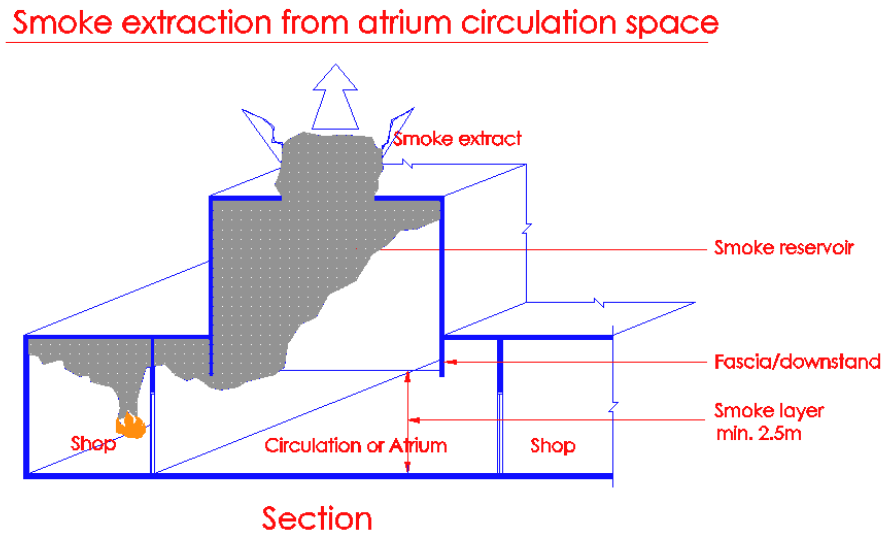
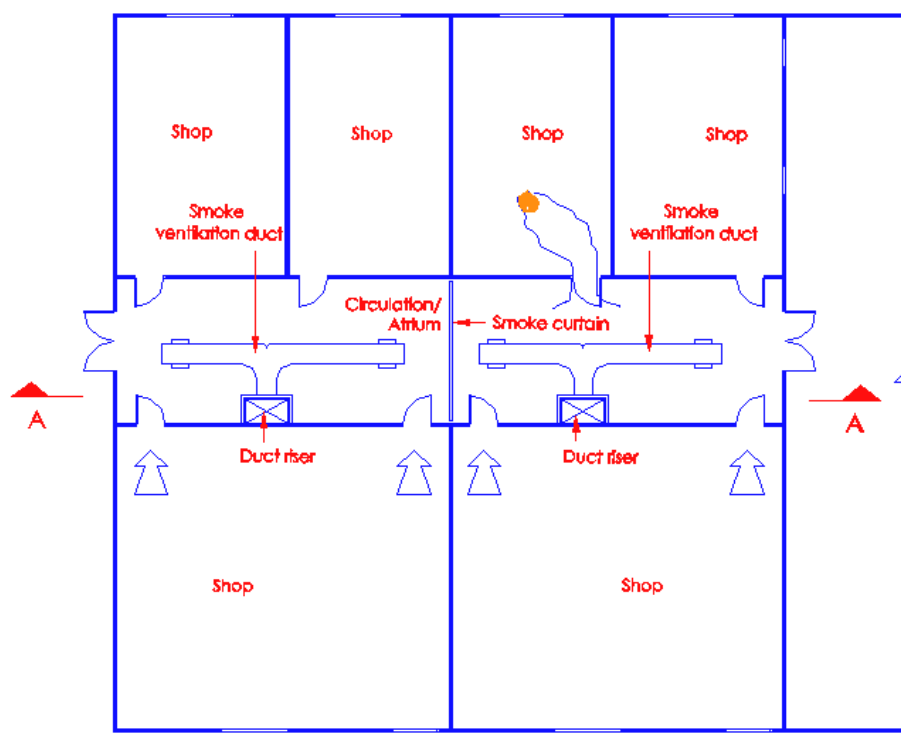
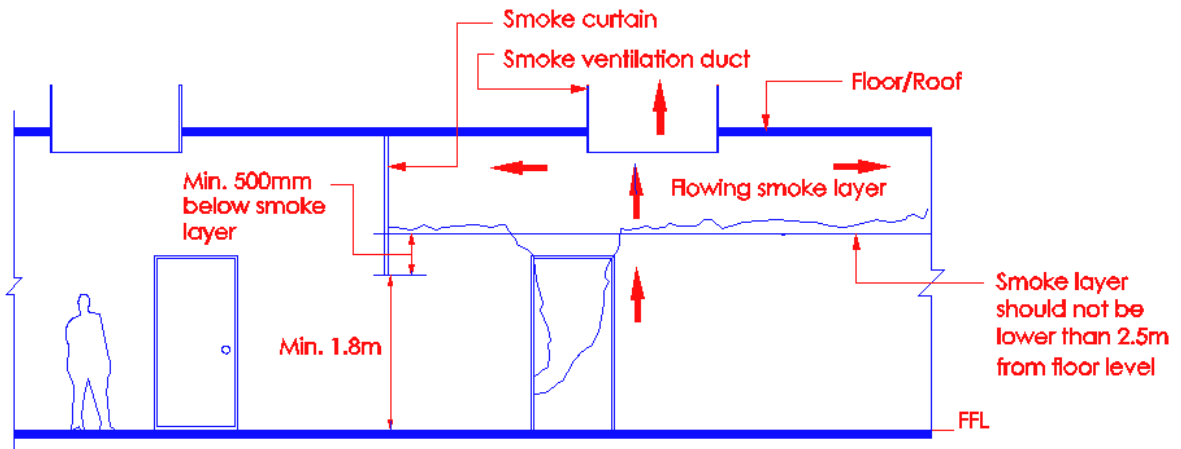

Diagram 7.6.8-1



Plan



Elevation A

For cases where smoke is allowed to spill into the circulation or atrium space before extraction takes place, the smoke reservoir sizes are halved. Individual smoke reservoir can be created for circulation or atrium space, subject to 1300m² for mechanical ventilation or 1000m² for natural ventilation.

The smoke reservoirs could be formed by using either the building's geometry or by using smoke curtains/shutters/non-combustible downstands.

The depth of any screen used for subdivision shall be taken into account. Screens should terminate at a minimum of 500mm below the smoke layer base, and shall be min. 1.8m above finished floor level.

The main reasons for restricting to smaller reservoir size as compared to smoke extraction from room of origin are:

- a) smoke from a fire leaves a shop and enters the smoke reservoir in the circulation or atrium space, it will encounter turbulence and greater mixing occurs which produces more smoke; and*
- b) the movement of smoke from shop into the circulation or atrium space would cause the smoke to lose heat to the surrounding structure through conduction and further loss occurring due to downward radiation. This movement would cause the smoke to lose some of its buoyancy.*

The circulation or atrium space serves as a means of escape for people escaping from the shop, before exiting to a safe area outside the building. The circulation or atrium space is therefore an additional stage to the escape route, which requires to be protected from the effects of fire and smoke.

7.6.9 Discharge of smoke into circulation/ atrium spaces

For cases where smoke is removed from the circulation space or atrium space, the rooms discharging smoke into the circulation space/atrium spaces shall either:

- (a) have a floor area of not exceeding 1000 sq m (for natural ventilation system) or 1300 sq m (for mechanical ventilation system) or
- (b) be subdivided such that smoke is vented to the circulation space or atrium only from part of the room with floor area not exceeding 1000 sq m (for natural ventilation system) or 1300 sq m (for mechanical ventilation system) that are adjacent to the circulation space or atrium. However, the remainder of the room needs to be provided with an independent smoke ventilation system(s).

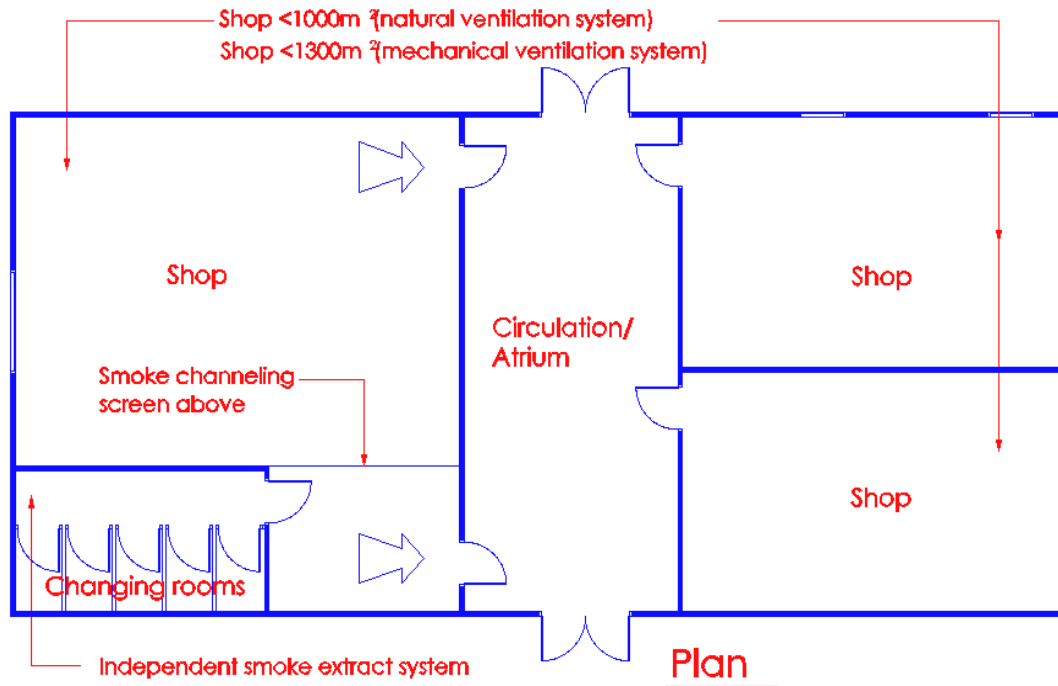

Diagram 7.6.9(a)-1

The main purpose of controlling the maximum floor area is to limit the distance to the circulation or atrium space as smoke and hot gases would tend to cool and lose their buoyancy if floor area becomes larger.

Where the shop units are not larger than 1000m² (natural ventilation in the circulation or atrium space) or 1300m² (with powered extraction in the circulation or atrium space), smoke from these units are allowed to discharge into the circulation or atrium space. If the units are larger than the sizes mentioned above, the smoke layer from a fire in any of these units would lose temperature to a great extent thereby losing its buoyancy as it would be controlled by sprinklers located within the units. In addition, the smoke layer would also lose some heat to the building structures. Thus, the venting of smoke layer into the circulation or atrium space becomes not effective, as cooling of smoke takes place leading to dispersal of smoke and smoke logging.

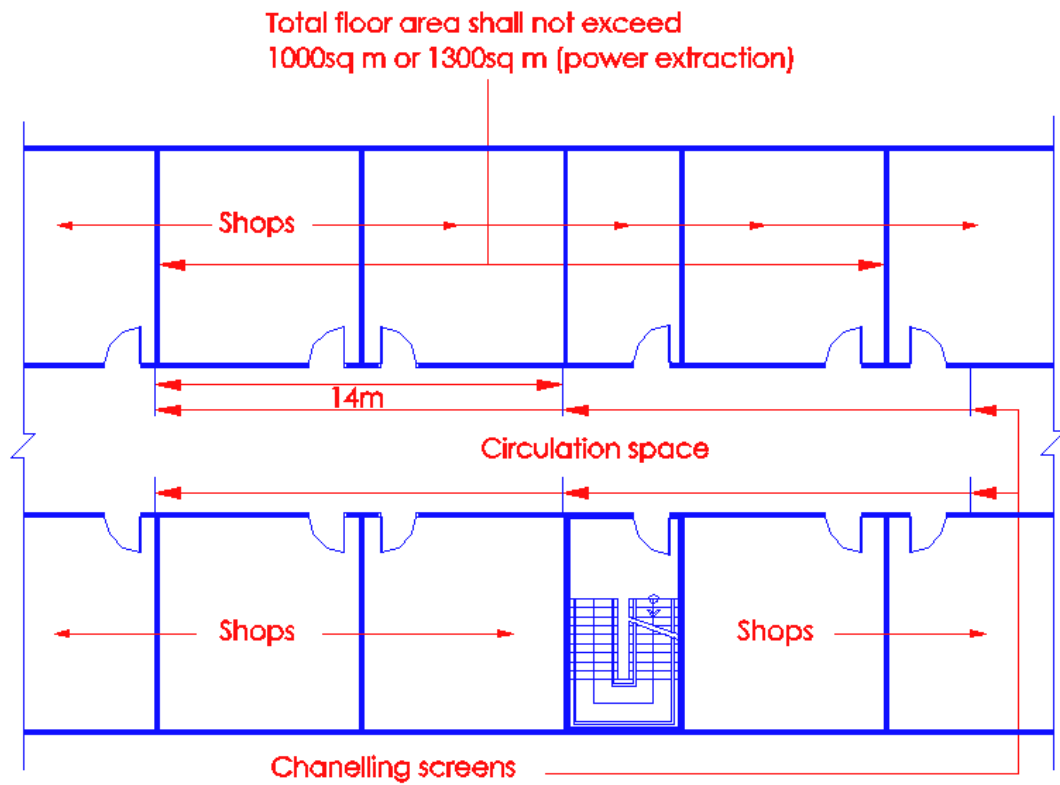
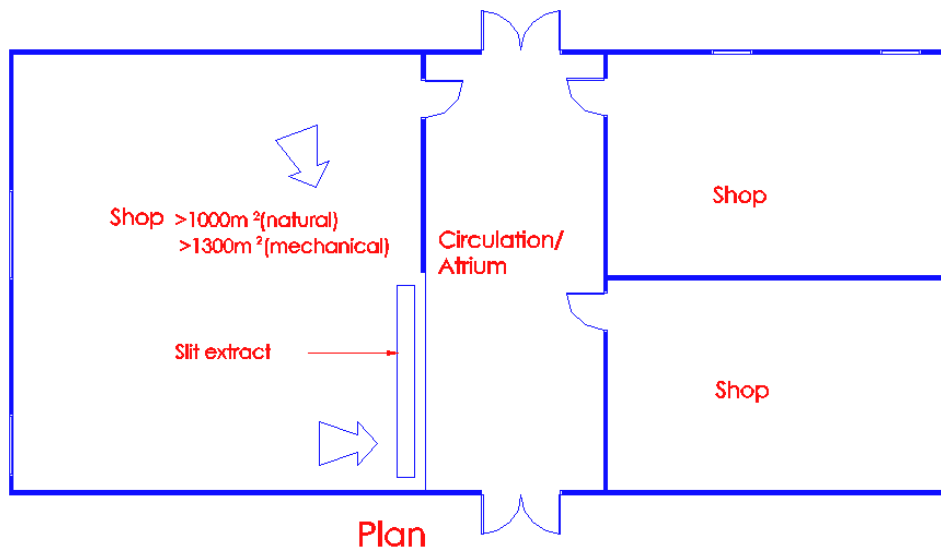

Diagram 7.6.9(a)-2

The combined floor area of multiple shops should not exceed 1000m² or 1300m² (power extraction) fronting circulation or atrium space. It is acceptable to use screen to channel the smoke from the shop into the circulation or atrium space, subject to maximum 14m separation between channel screens.



Where a large shop is extracted separately from the circulation/atrium space, it can have ceiling reservoirs up to twice the area permitted in the circulation/atrium space; 2000m² (natural ventilation system) or 2600² (mechanical ventilation system) as no smoke is allowed to spill into the circulation/atrium space.

7.6.10 Length of smoke reservoir

The maximum length of the smoke reservoir shall not exceed 60 m.

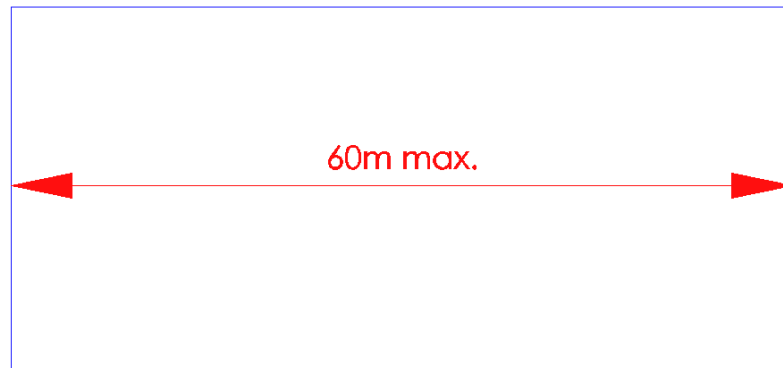

Rectangle shaped smoke reservoir

Figure 1

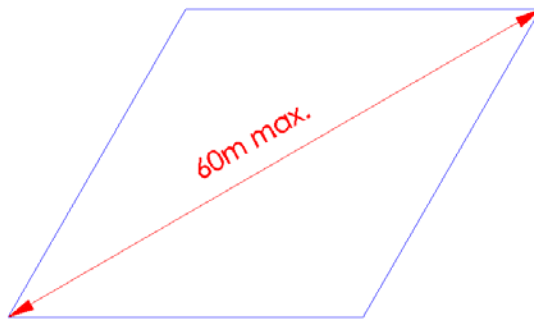

Rhombus shaped smoke reservoir

Figure 2

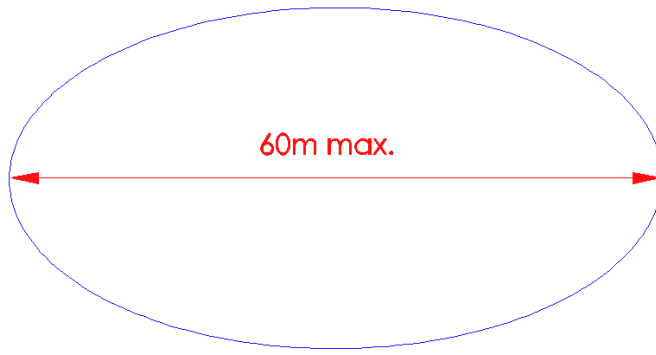

Oval shaped smoke reservoir

Figure 3

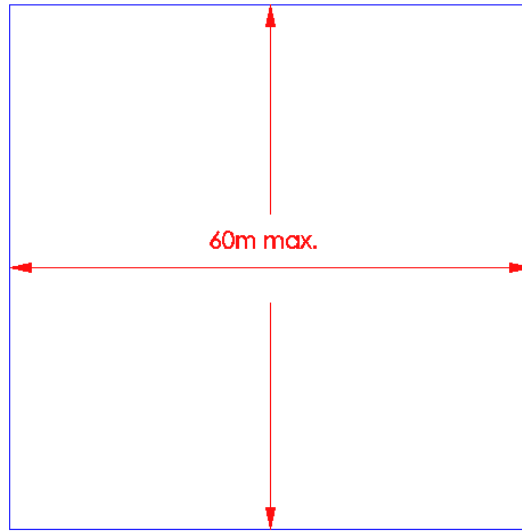

Square shaped smoke reservoir

Figure 4

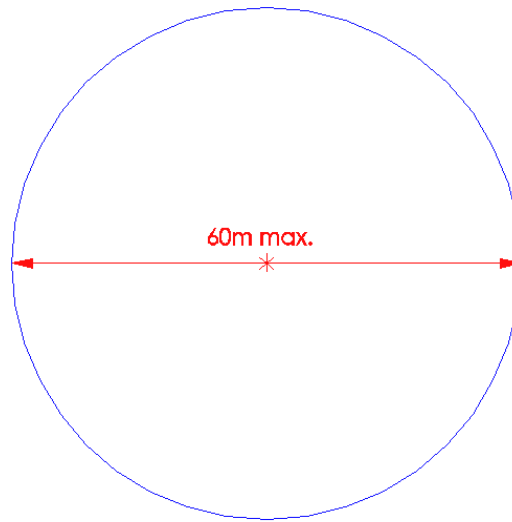

Circular shaped smoke reservoir

Figure 5

Smoke reservoirs can be formed of different shapes. In order to prevent smoke from excessive heat loss, the length of an individual smoke reservoir within a mall, atrium spaces shall not exceed 60m.

7.6.11 Stagnant regions

Adequate arrangement(s) shall be made in each smoke reservoir for the removal of smoke in a way that will prevent the formation of stagnant regions.

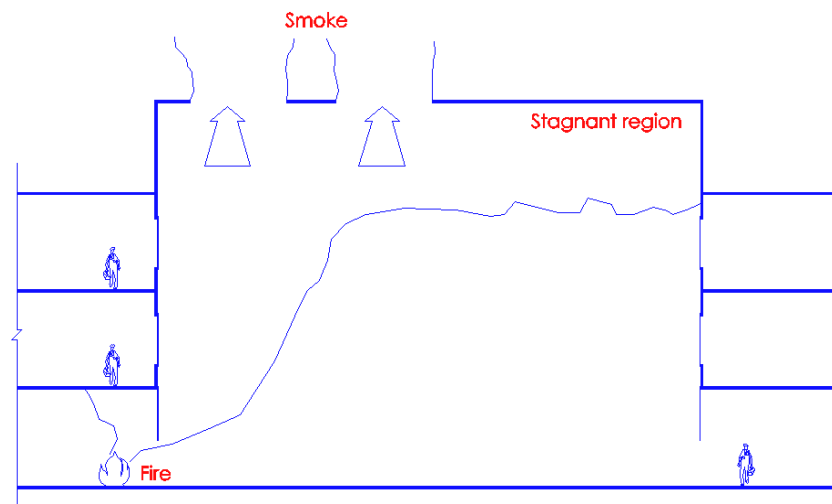

Diagram 7.4.11-1

A stagnant region occurred in a long smoke reservoir when venting or extraction is not properly distributed or when circulation/atrium or mall has a closed end.

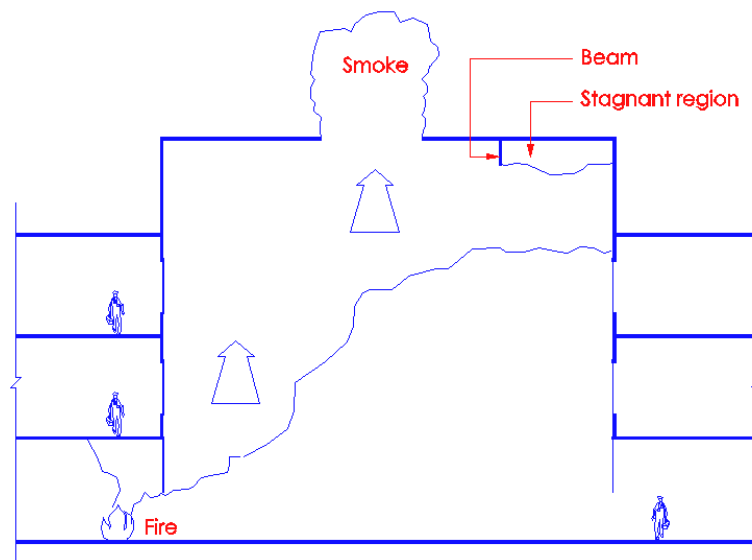

Diagram 7.4.11-2

A stagnant region could also be formed by physical obstruction in the smoke reservoir eg. beam. If a smoke layer is stagnant, it will cool down and will mix into the air below. If the air space under a smoke layer is stagnant, it will tend to fill up with hazy smoke of sufficient density to affect visibility. Venting or extraction should be well distributed in the smoke layer or smoke reservoir. The air inlets at low level should also be well distributed so that the air, which is being drawn in will purge as much of the low-level clear air as possible.

7.6.12 Maximum mass flow/ smoke layer temperature

Owing to practical limitation, a smoke ventilation system shall have:

- (a) a maximum mass flow not exceeding 175 kg/s; and
- (b) a minimum smoke layer temperature of 18°C above ambient.

(No illustration)

- (a) *It has commonly been found that very large exhaust rates, typically larger than about 175kg/s, would require large and heavy fans or ventilators. Large and heavy fans or ventilators when in operation would cause vibration problems to the building structures.*
- (b) *A minimum design temperature is required to maintain stability of the smoke layer. Smoke layers, which have temperatures approaching that of the replacement air will have a tendency to mix with this air rather than to float above it.*

The stipulated minimum design layer temperature is intended to be high enough to allow safe operation of the system for fires, which are smaller than the full design size.

7.6.13 Replacement air shall be by natural means drawing air directly from the external.

(a) Replacement air velocity

The design replacement air discharge velocity shall not exceed 5.0 m/s to prevent the escapees being hindered by the air flow.

(b) Distance from exhaust air discharge

Replacement air intake shall be sited at least 5 m away from any exhaust air discharge.

(c) Replacement discharge position

Replacement air shall be discharged at a low level, at least 1.5 m beneath the designed smoke layer, to prevent “fogging” of the lower clear zone.

(d) Siting of inlets

Where the inlet cannot be sited at least 1.5 m below the smoke layer, a smoke curtain or a barrier shall be used to prevent replacement air distorting the smoke layer.

(e) Where replacement air is taken through inlet air ventilators or doorways, devices shall be incorporated to automatically open such inlet ventilators and doors to admit replacement air upon activation of the smoke ventilation system.

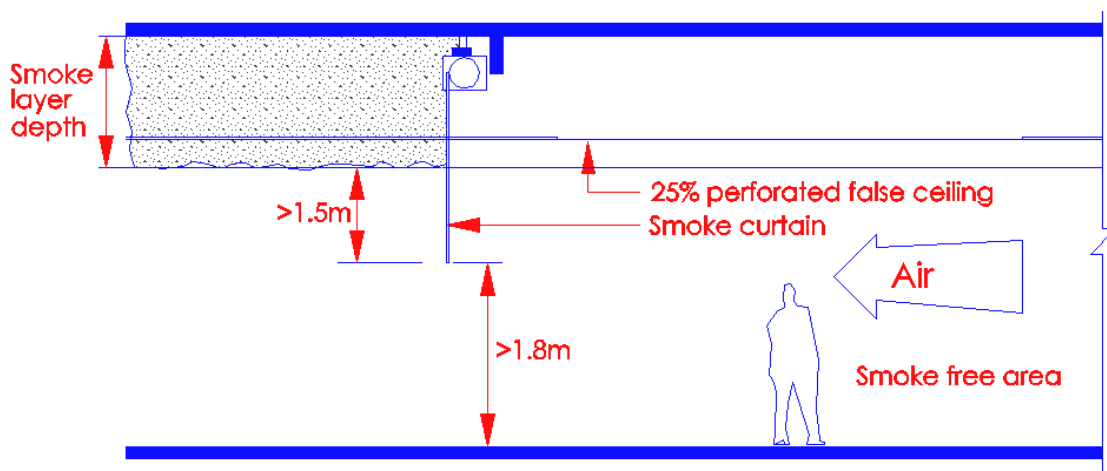

Diagram 7.6.13- 1

The use of fan-driven inlet air supply can give problems with mechanical extraction. This is because the warmed air taken out will have a greater volume than the inlet air. As the fire grows and declines, the mismatch in volume between the inlet air and the extracted fire warmed air will also change. This can result in significant pressure differences appearing across any doors on the escape routes. Hence, to avoid this "push-pull" effect, replacement air shall be drawn by natural means.

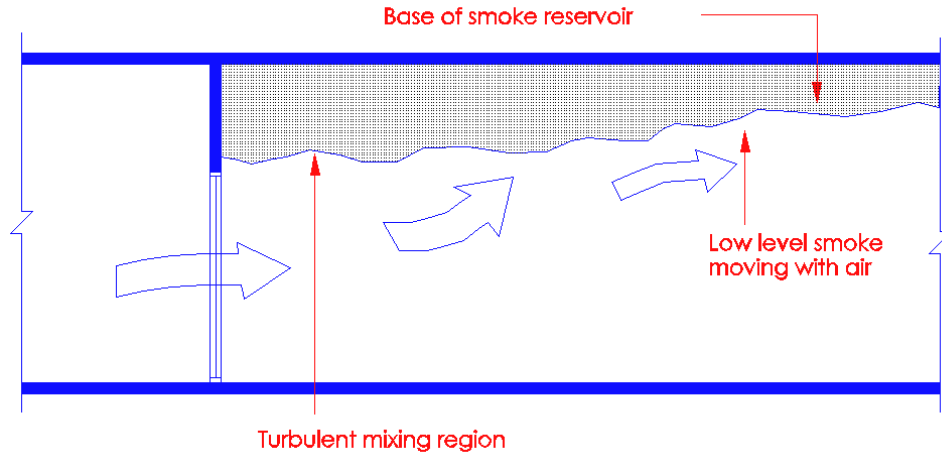

Diagram 7.6.13-2

The interaction between an air-inlet (e.g. a door) and a reservoir

A moving airstream in contact with a region of stationary air (or smoke, or gas) will have a lower pressure than the stationary air – this is the Venturi effect. Hence, a moving airstream will attract the stationary air towards itself. The force of attraction increases with increasing velocity of the airstream. In diagram 7.6.13 – 2, the clean airstream flowing through the door attracts the smoke towards itself. The smoke reservoir base follows the surface of constant pressure, and bulges downwards near the door. Unless the reservoir base is high enough above the door (at least 1.5m), the smoke base will come just below the top of the door.

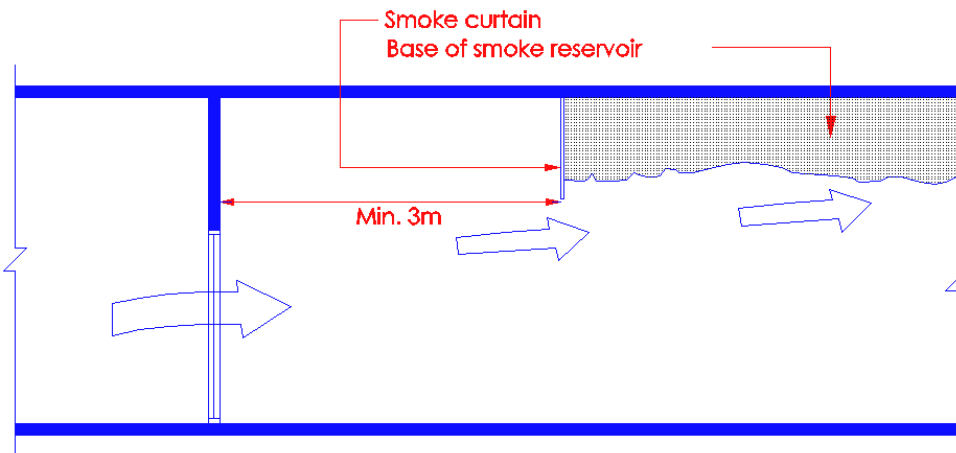

Diagram 7.6.13-3

Where inlets (e.g. door) cannot be sited at least 1.5m below the base of smoke layer, either a smoke curtain or a non-combustible horizontal screen could be used to prevent inlet air distorting the smoke layer. Diagram 7.6.13 – 3 shows a smoke-restraining curtain set back from the door. The curtain's bottom edge is higher than the door. The incoming air stream will increase in vertical section as it travels from the door to beneath the curtain, and so will slow down. There are fewer tendencies to pull down the smoke-base. There is less turbulence at the smoke/air interface mixing smoke into the air stream and any such mixed smoke is at a higher level. The curtain shall be more than 3m away from the door.

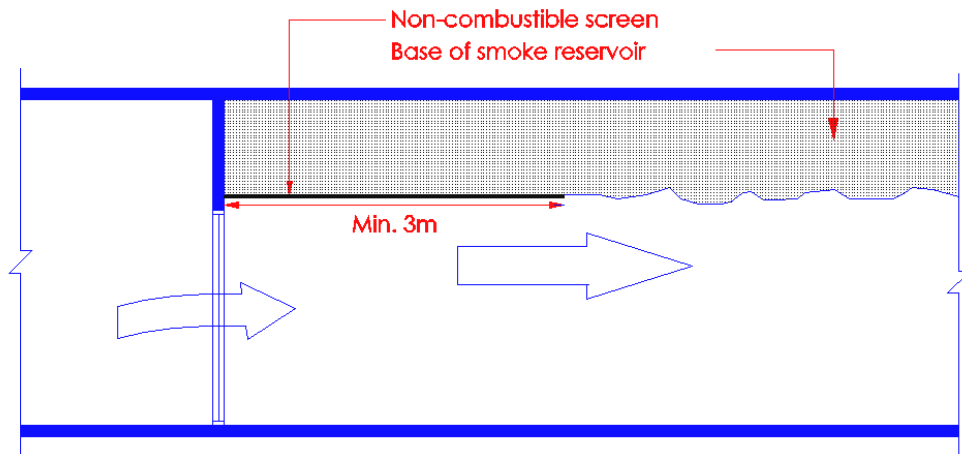

Diagram 7.6.13- 4

Using a horizontal non-combustible screen instead of a smoke curtain, which permits the same air expansion and gives the same results. The screen-edge should be more than 3m away from the door.

7.6.14 Perforated ceiling

For cases where the smoke reservoir is above the false ceiling, the ceiling shall be of perforated type with at least 25% opening.

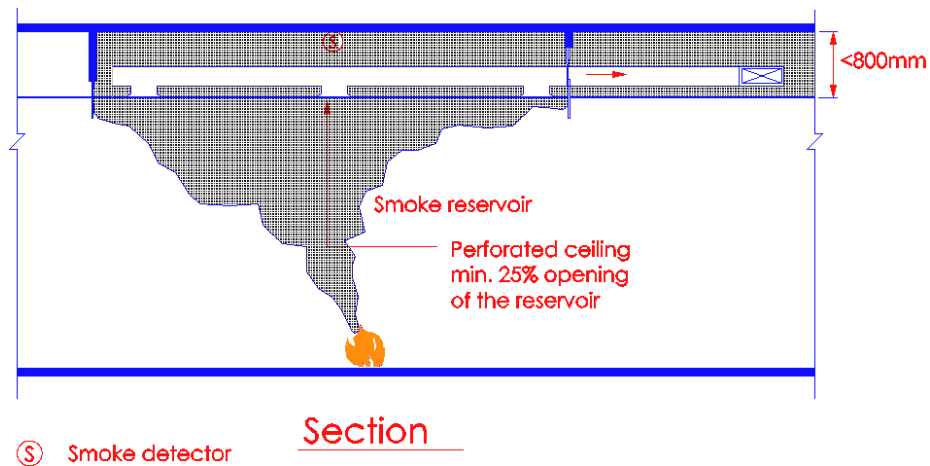

Diagram 7.6.14

If the smoke reservoir incorporates a false ceiling, then the space above the false ceiling may be included in the depth of the smoke reservoir provided the screens forming the reservoir extend up to the structural ceiling, the perforations in the false ceiling are at least 25% of the total area of the reservoir, and the space occupied by services etc. shall be such that there shall be no creation of stagnant region.

7.6.15 Emergency power supply

The smoke ventilation system shall be provided with secondary source of power supply.

(No illustration)

All the associated systems/mechanisms, like the door venting actuators, are to be back-up by secondary power supply such as generator set or battery packs as appropriate.

7.6.16 Mode of Activation

The smoke ventilation system shall be activated by smoke detectors located in the smoke control zone. Use of smoke detectors for activation must be carefully designed so that accidental or premature activation of smoke detectors on a non-fire zone due to smoke spills or spread from other areas must be avoided.

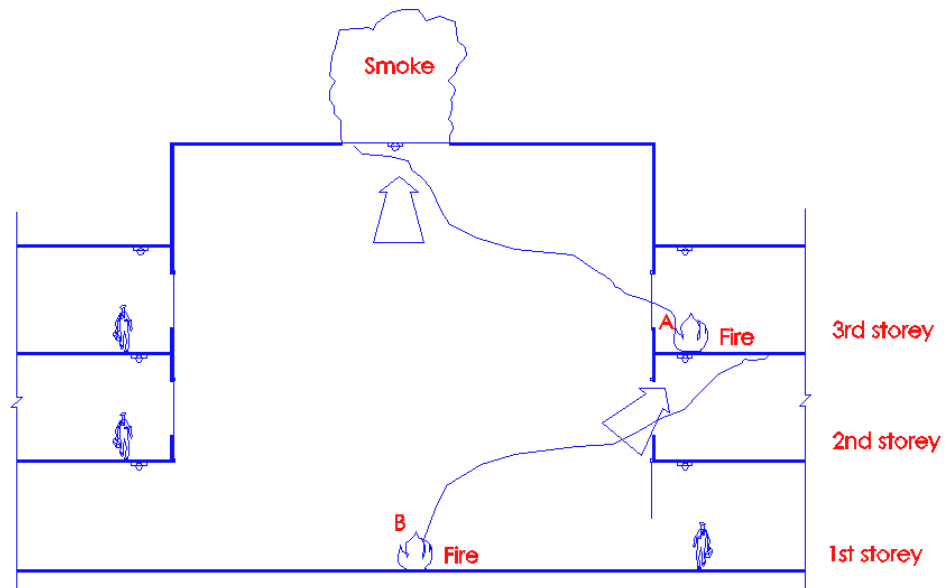

Diagram 7.6.16

Scenario A :

A fire occurring at 3rd storey failed to activate the smoke detector at that level owing to its poor location. Instead, smoke is allowed to spill into the atrium void and smoke control system for the building is activated. This would release all the smoke curtains overlooking the atrium void, including the fire floor, which is not correct. As a result, smoke and heat will be retained in the fire floor. The correct sequence of events should be that the smoke detectors at the fire floor should be activated first, thereby locking the smoke curtain, while releasing all smoke curtains in other parts of the building.

Scenario B

A fire occurring at the atrium floor caused smoke to spill and activate the smoke detector in 2nd storey. The smoke curtain will remain locked but at other floors, the smoke curtains will descend down. As a result, part of 2nd storey will be smoke logged.

Smoke control system reacts to the first signal sent by the detector. To overcome the above problem, it is recommended that closer spacing of smoke detectors, closer than the permitted limit in SS CP10, be adopted and that the detectors should be placed correctly in close proximity of the atrium void.

7.6.17 Provision of activating smoke detectors shall comply with CP 10.

(See illustration under Cl.7.6.16)

The smoke ventilation system shall operate automatically upon detection of smoke by smoke detector placed strategically at the smoke control zone. The layout of smoke detectors shall comply with CP 10.

7.6.18 Manual activation

A remote manual activation and control switches as well as visual indication of the operation status of the smoke ventilation system shall also be provided at the fire command centre and where there is no fire command centre, at main fire indicator board.

(No illustration)

The provision of remote manual activation and control switches located at Fire Command Centre or Fire Indicator Board would permit better monitoring of the smoke ventilation system.

In the event of the smoke detectors malfunctioning, the atrium smoke extract system can be activated by a manual switch, which performs the function of the smoke detectors in actuating the associated devices for the isolation and extraction of the smoke from the affected areas.

7.6.19 Shut down of other air conditioning & ventilation systems

Except for ventilation systems in Cl.5.2.1 (g) and (h), all other air-conditioning and ventilation systems within the areas served shall be shut down automatically upon activation of the smoke ventilation system.

(No illustration)

Mechanical ventilation to the following room or space should not be affected:

- (i) exit staircases and exit passageways;*
- (ii) smoke-stop and fire fighting lobbies;*
- (iii) areas of refuge within the same building;*
- (iv) basement car parks;*
- (v) fire command centres;*
- (vi) flammable liquid/gas storage room;*
- (vii) emergency generator;*
- (viii) engine driven fire pump.*

AHUs serving the affected smoke zone are to be shut down automatically upon activation of the smoke ventilation system, while the rest may continue to function.

7.6.20 Standby fans or multiple fans

Either a standby fan or multiple fans with excess capacity shall be provided for each mechanical smoke ventilation system such that in the event the duty fan or the largest capacity fan fails, the designed smoke extraction rate will still be met. The standby fan shall be automatically activated in the event the duty fan fails.

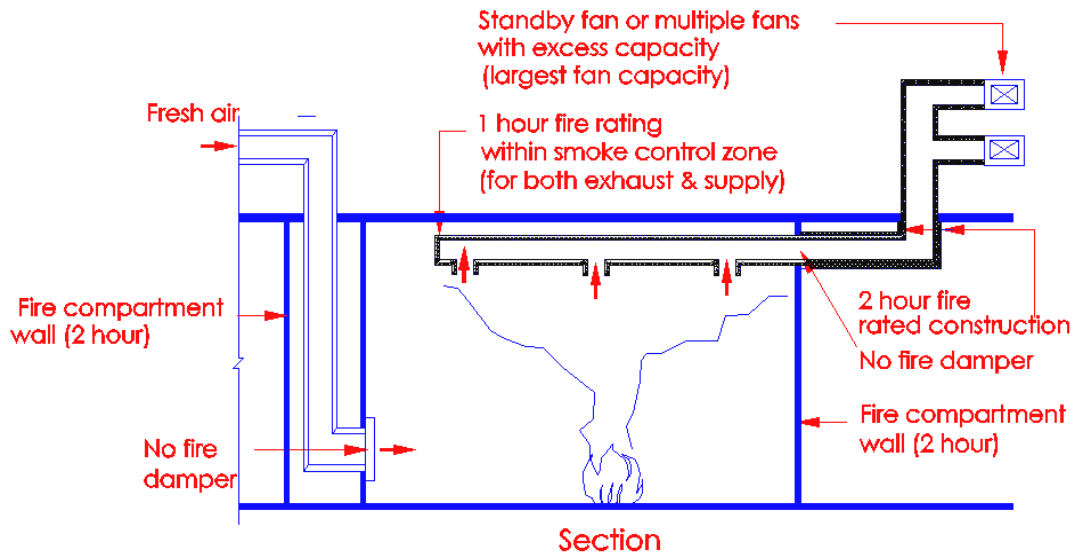

Diagram 7.6.20

Only one additional fan is required as standby fan for each designated smoke zone. That means that if only one fan is required to serve an area, then only one additional fan of its equal capacity is required as its standby fan.

If two or more fans of equal capacity are provided to serve an area, then an additional fan of the same capacity need only be provided as the standby fan.

If more than one fan are provided, and are of differing capacities, thence the single standby fan shall have the same capacity as the fan with the highest capacity serving that zone.

See Cl. 7.6.24 on the requirements on the requirements on fire rating of ducts.

7.6.21 Fans shall be capable of operating at 250°C for 2 hours.

(No illustration)

The fans shall have the capability to handle high temperature smoke at 250°C and remain operational for a period of not less than 2 hours.

7.6.22 Protected circuits

The fans and associated smoke control equipment shall be wired in protected circuits designed to ensure continued operation in the event of the fire.

(No illustration)

Since the smoke control system is installed to remove smoke and heat from the building to aid evacuation of occupants and fire fighting operations, the system's circuits shall be protected to ensure operational reliability and sustained operation during fire emergency.

7.6.23 Electrical supply

The electrical supply to the fans shall, in each case, be connected to a sub-main circuit exclusive thereto after the main isolator of the building. The cables shall be of at least 1-hour fire resistance in accordance with SS CP 299.

(No illustration)

The main purpose is to ensure that the electrical supply to the fans could be maintained continuously for at least 1 hour.

7.6.24 Fire rating of ducts

Smoke ventilation ducts (both exhaust and replacement air ducts) shall be of at least 1 hour fire resistance. Where a duct passes through other fire compartment of higher rating, the duct shall be constructed to have the rating as that of the compartment. The rating shall apply to fire exposure from both internal and external of the duct or structure and the duct shall also comply with sub-cl.7.1.1(j).

(See illustration under cl.7.6.20).

7.6.25 Fire damper

Fire damper shall not be fitted in the smoke ventilation system.

(See illustration under cl.7.6.20)

Fire damper is not allowed to be fitted in the duct work of atrium smoke control system. In fire situation, the exhaust ducts and supply ducts must continue to operate for the duration of the fire. Provision of fire damper in the duct work will cause the smoke control system to fail.

However, in building which are provided with common mechanical extraction to every floor, all exhaust ducts on all unaffected floor must be closed off by fire damper to prevent smoke and fire spread. See illustration below :

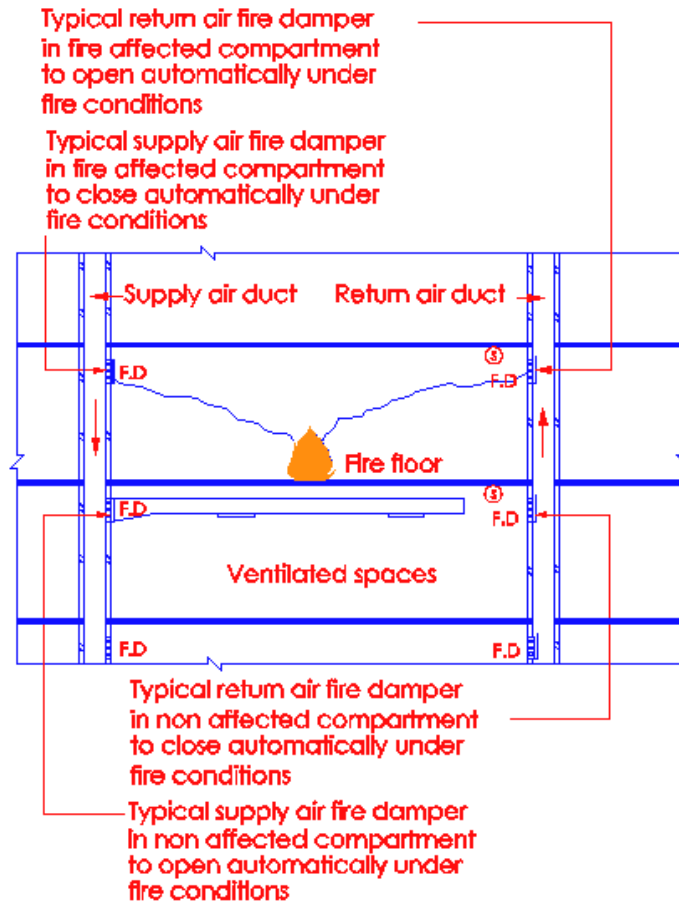

Diagram 7.6.25

The fire damper to the exhaust duct on the fire floor remains open, whereas, for other floors, the fire dampers are in closed position.

7.6.26 Activation of system

The time taken for the smoke ventilation system within a smoke zone to be fully operational shall not exceed 60 seconds from system activation.

(No illustration)

7.6.27 Fail-safe system

For natural smoke ventilation system the natural ventilators shall be :

- (a) in the "open" position in the event of power/system failure; and

- (b) positioned such that they will not be adversely affected by positive wind pressure.

(No illustration)

Wrong positioning of roof ventilators can cause the wind to be deflected into the atrium roof space, thereby pushing the smoke downward into the building. Roof adjacent to tall buildings could be subjected to positive pressure. It is for the designer to prove that his design will be satisfactory.

7.6.28 Natural/powered exhaust ventilation

Natural exhaust ventilation shall not be used together with powered smoke exhaust ventilation.

Not Acceptable

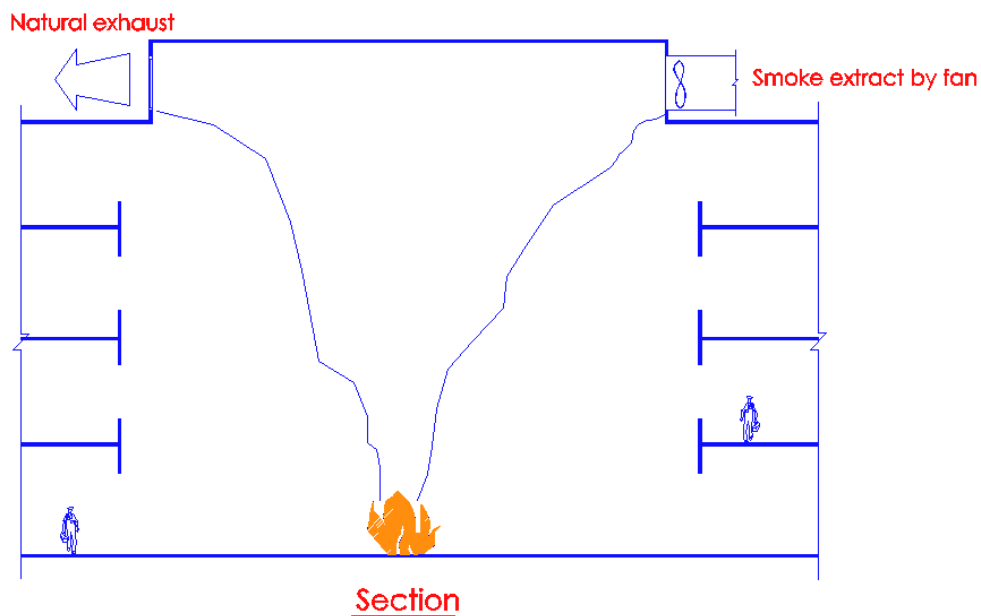

Diagram 7.6.28

The combination of natural exhaust ventilation and powered smoke exhaust ventilation in a building would create complications on the design of the distance between the bottom of the smoke reservoir and the floor.

7.6.29 Smoke curtains

All smoke curtains where required, unless permanently fixed in position, shall be brought into position automatically to provide adequate smoke-tightness and effective depth.

(No illustration)

The intent of the smoke curtain is to contain the smoke and to prevent spillage of smoke to other areas. All smoke curtains are required to be under the PSB Product Listing Scheme.

7.6.30 Obstruction to means of escape

Smoke curtain or other smoke barrier at any access route forming part of or leading to a means of escape shall not in their operational position obstruct the escape of people through such route.

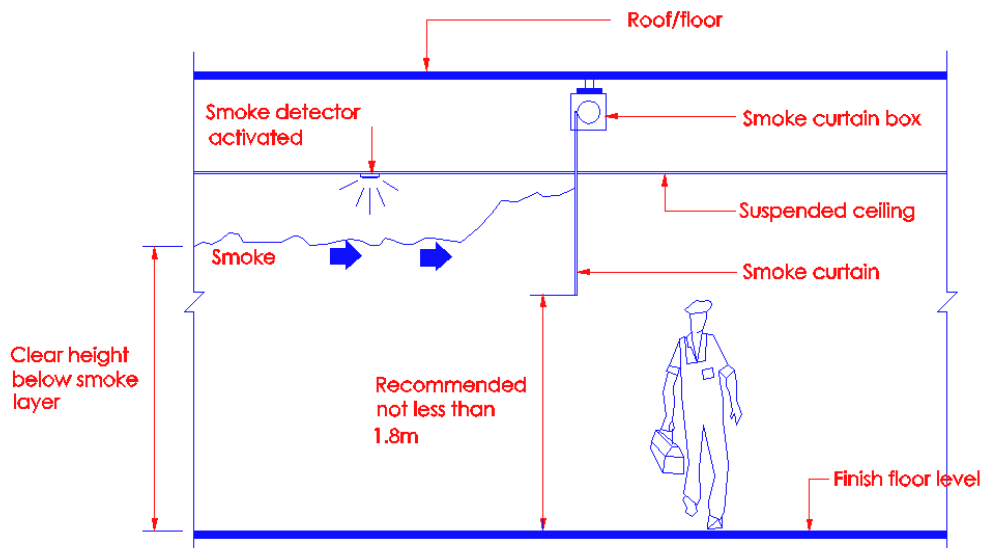

Diagram 7.6.30

Upon activation of smoke detector, the smoke curtain is automatically unfurled from its roller under gravity fall to impede smoke flow. The dropped curtains limit the area of smoke spread, maintain visibility and tenable conditions for escape purposes.

Smoke curtain in operation should not obstruct the escape routes. The clear height of smoke curtain across the escape routes should not be lower than 1.8m from its finished floor level.

7.6.31 Smoke or channelling screens

Where glass walls or panels are being used as smoke screens to form a smoke reservoir or as channelling screens, they shall be able to withstand the design highest temperature.

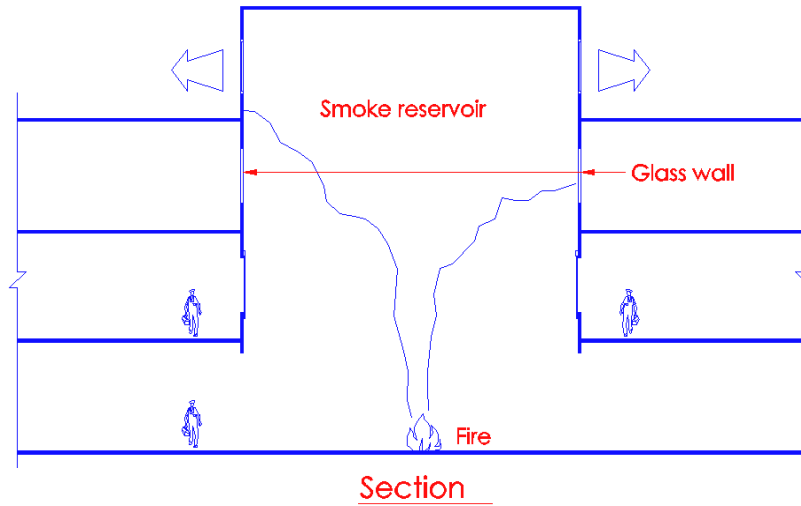

Diagram 7.6.31-1

Wired glass or tempered glass could be used as smoke screen to form smoke reservoir, provided they are able to meet the designed highest temperature. Glass walls or panels acting as smoke screen shall not be of sliding, louvres or openable type.

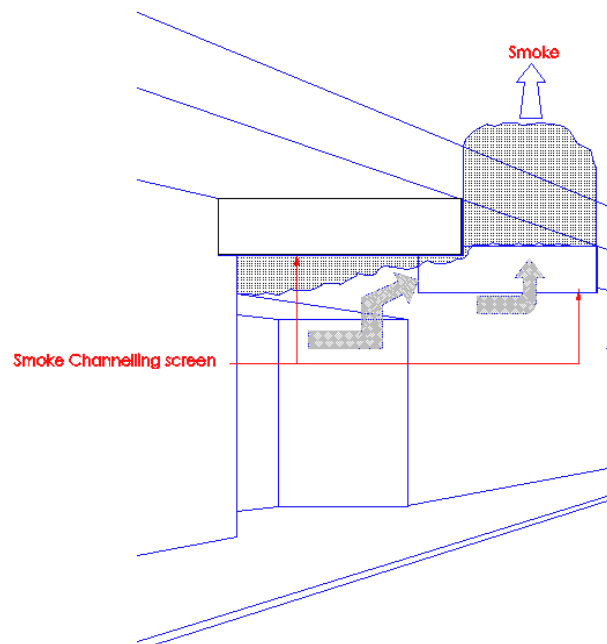

Diagram 7.6.31-2

Smoke screens, which are to meet the designed highest temperature, could be used to form smoke reservoirs to limit lateral spread. Smoke channelling screens are used to channel smoke away from the origin of fire to smoke reservoirs where extraction can be carried out, or away from the building entrance canopies to the external open space as shown above.

It is recommended that the spacing between channelling screens should not be more than 14m so as to prevent lateral spread of smoke and excessive cooling.

7.6.32 Quality control

All smoke control equipment (including smoke curtains) shall be supplied and installed in accordance with the accepted standards eg BS 7346.

(No illustration)

Fixed screen shall be constructed of non-combustible materials capable of resisting the highest design temperatures. Automatic retractable smoke curtains are required to comply with BS 7346 and listed under PSB Product Listing Scheme.

7.7.1 Provision of smoke vents having 2½% of the floor area shall be provided to auditorium which is not sprinkler protected and to auditorium having floor area more than 500m², if sprinkler protected. The opening of the smoke vents shall be by automatic device.

7.7.2 In place of smoke vents, an engineered smoke control system would be considered as acceptable.

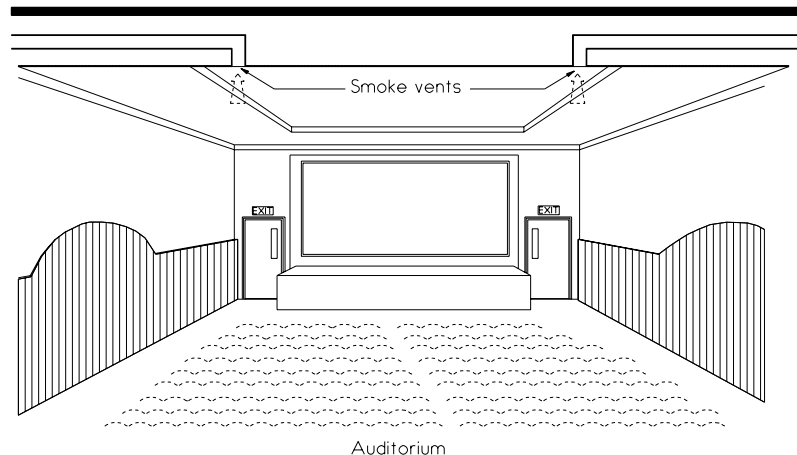

Diagram 7.7.2

Auditorium includes cineplex in shopping centres, ballroom, convention hall, lecture theatre, exhibition centre, large meeting room, large conference room, room with mass seating which are windowless shall comply with the above requirement. Smoke vents having 2½% of the floor area are to be provided for:

- (a) windowless auditorium not protected by sprinkler system;*
- (b) windowless auditorium exceeding 500m² protected by sprinkler system;*
- (c) in lieu of smoke vents, engineered smoke control system is to be provided.*