

## Chapter 3

### STRUCTURAL FIRE PRECAUTIONS

#### 3.1 GENERAL

- 3.1.1 The purpose of this chapter of the Code is to stipulate requirements to minimise the risk of spread of fire between adjoining buildings by separation, prevent the untimely collapse of buildings in the event of fire by the provision of a stable and durable form of construction and prevent the spread of fire between specified parts of the buildings by the division of such buildings into compartments.

*Structural fire precautions relate to the integrity and stability of building elements during fire for a required period of time. "Structural" does not only apply to the structural elements of buildings but other building components, e.g. doors, shafts, walls/ceiling finishes.*

*The objectives of structural fire precautions are :*

- (a) To prevent the spread of fire between adjoining buildings by adequate separation;*
- (b) To prevent the untimely collapse of building, including walls and floors of each unit in the event of a fire*
- (c) To prevent spread of fire from one unit to another within the building envelope by compartmentalising each unit with walls, floors and doors having the requisite fire resistance rating.*

#### 3.2 PROVISION OF COMPARTMENT WALLS AND COMPARTMENT FLOORS

- 3.2.1 Compartment size – floor area and cubicle extent

Any building which has -

- (a) Any storey the floor area of which exceeds that specified as relevant to a building of that height in column (2) of Table 3.2A, or
- (b) A cubic capacity which exceeds that specified as relevant in column (3) of Table 3.2A,

shall be divided into compartments by means of compartment walls and compartment floors so that –

- (i) no such compartment has any storey the floor area of which exceeds the area specified as relevant to the building in column (2) of the Table, and
- (ii) no such compartment has a cubic capacity which exceeds that specified as relevant in column (3) of the Table.

*Compartment size – floor area & cubical extent*

*Generally, the compartment size of institutional usage would not exceed 4000m<sup>2</sup> or a cubical extent of 15000m<sup>3</sup> as given in Table 3.2A which is reproduced below:*

TABLE 3.2A SIZE LIMITATION OF BUILDING AND COMPARTMENT

(1) Compartments	(2) Maximum Floor Area	(3) Maximum Cubical Extent
Compartment below ground level. No compartment to comprise more than one storey.	2000m <sup>2</sup>	7500m <sup>3</sup>
Compartments between average ground level and a height of 24m. No compartment to comprise more than 3 storeys.	4000m <sup>2</sup>	15000m <sup>3</sup>
Compartments above a height of 24m from average ground level. No compartment to comprise more than one storey.	2000m <sup>2</sup>	7500m <sup>3</sup>

*Compartment below ground level*

- i) Under Table 3.2A no compartment shall comprise more than one storey and exceed floor area of 2000m<sup>2</sup> and a cubical extent of 7500m<sup>3</sup>. However, exceptions are allowed in the following situations:
  - a) Only 1<sup>st</sup> basement having a floor area of less than 100m<sup>2</sup> can form part of the 1<sup>st</sup> and upper storey compartment under Cl.3.2.5(a), provided the building is sprinklered protected including the basement.
  - b) Basement floors can be interconnected for use as car parking, if sprinkler system is provided.
- ii) Basement floor or compartment shall not be used for bulk storage of highly inflammable liquids or substances of any explosive nature.

Compartments between average ground level and a height of 24m

- i) No compartment shall comprise more than 3 storeys and floor area greater than 4000m<sup>2</sup> and cubical extent exceeding 15000m<sup>3</sup>. However, exceptions are allowed under clauses 3.2.3, 3.2.4(c) and 3.2.8.

Compartments above a height of 24m from averaged ground level

- i) No compartment shall comprise more than one storey and exceed the floor area of 2000m<sup>2</sup> and cubical extent of 7500m<sup>3</sup>.

*General :*

*In computing the extent of a compartment, protected shafts e.g. lift, staircases etc and separately compartmented lavatory/locker room may be disregarded. See cl.1.2.16 under Definition in Vol. 1 of the handbook for further illustration.*

3.2.3 Relevant Authority may consent to greater size

Where however, the Relevant Authority is satisfied that additional floor area and cubical extent are necessary for any such building or compartment or part thereof, as aforesaid, he may consent to such additional floor area and cubical extent, provided:

- (a) Such building or compartment thereof is fitted throughout with an automatic sprinkler system which complies with the requirements in Chapter 6,
- (b) There is proper accessibility of site to fire fighting appliances, in compliance with the requirements in Chapter 4,
- (c) All other measures have been or will be taken and maintained for lessening so far as is reasonably practicable, any danger from fire.

Such consent shall continue in force only while such building or compartment is used for the purposes in respect of which consent was given.

*(No illustration)*

*To avoid providing fire compartmentation in building to comply with the cubical extent and floor area control under Table 3.2A, automatic sprinkler system would be proposed as an alternative. Where automatic sprinkler system is to be provided to a building, compliance with Table 3.2A on max. 3 storeys per compartment is still required, unless atrium design is proposed subject to obtaining SCDF (FSSD)'s prior approval before submission of building plan.*

Qps should consult SCDF (FSSD) for all atrium designs. Requirements provided under clause 7.5 and 3.2.4(c) are to be complied with respectively.

### 3.2.4 Compartmentation by height

- (a) In any compartment except those mentioned under sub-clause 3.2.4(d), up to a habitable height of 24m, no compartment shall comprise more than three storeys.

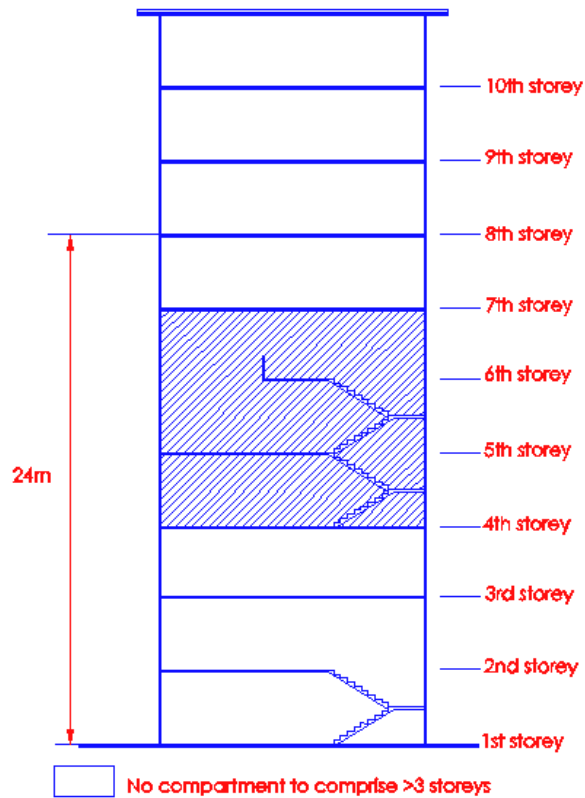

Diagram 3.2.4(a)

Up to a habitable height of 24m, no compartment shall comprise more than three storeys. The total floor area of the compartment shall not exceed 4000m<sup>2</sup> and the total cubical extent shall not exceed 15000m<sup>3</sup>.

- 3.2.4 (b) In any building which exceeds 24m in habitable height, no compartment shall comprise more than one storey for compartments at storey level exceeding 24m above average ground level.

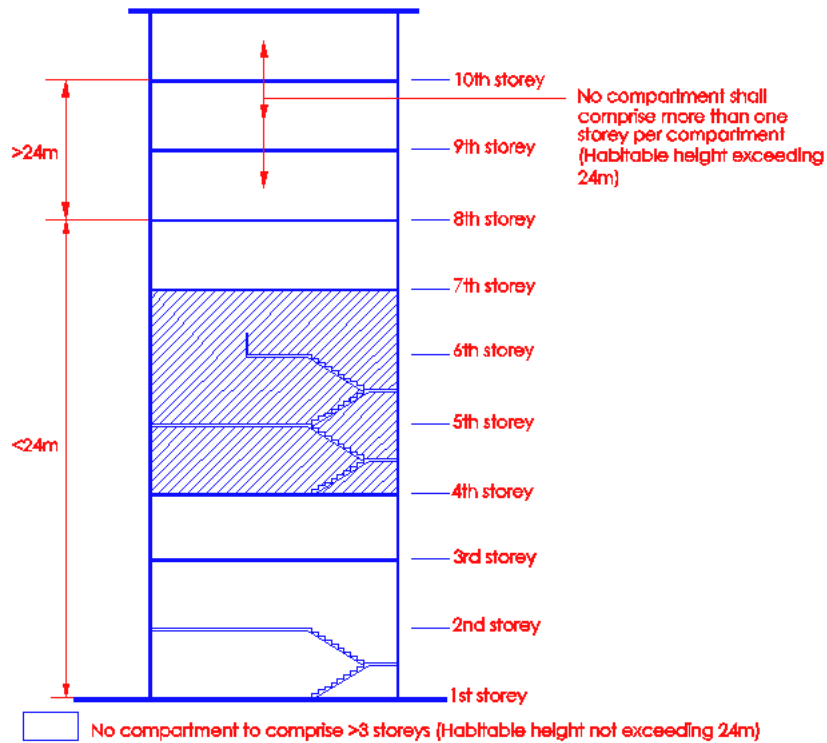

Diagram 3.2.4(b)

In any institutional building which exceeds 24m in habitable height, no compartment shall comprise more than one storey per compartment from storey level exceeding 24m above average ground level. There is a need to keep the fire compartment size small within 2000m<sup>2</sup> or 7500m<sup>3</sup> above that habitable height, as it would otherwise pose difficulties to fire fighting and control of fire spread should there be a fire occurrence in one of those high-rise units.

- (c) The Relevant Authority may consent to the relaxation of the requirements under Cl. 3.2.4(a) and (b) for Atrium spaces provided the design of such spaces complies with the conditions stipulated for "Atrium" spaces.

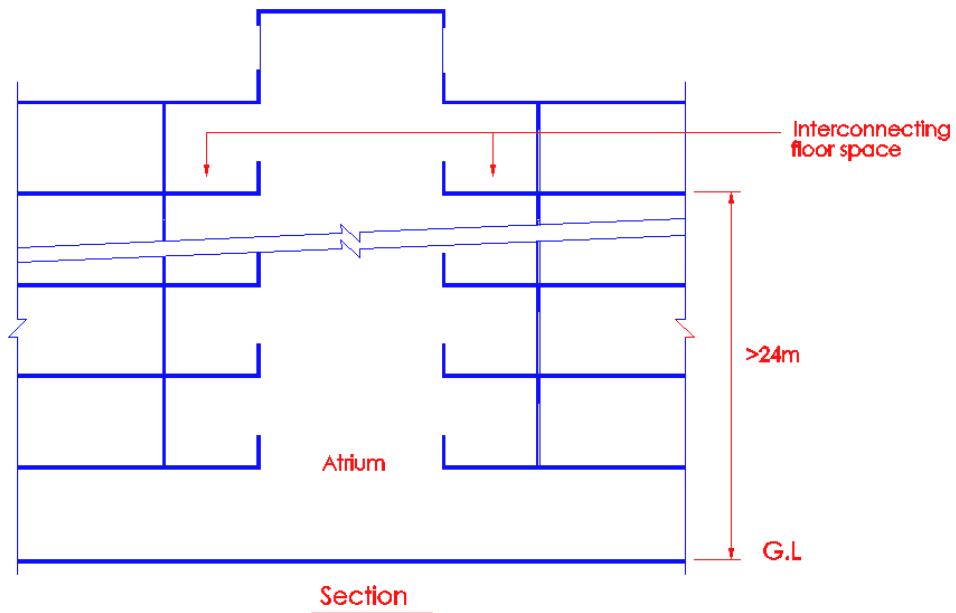

Diagram 3.2.4(c)

Atrium design allows more than 3 floors to be interconnected by large voids even beyond the habitable height of 24m. The design would require the provision of engineered smoke control system and sprinkler system. The above clause allows atrium design in buildings, but prior approval from SCDF(FSSD)) must be obtained before making any building plan submission. See clause 1.2.5 of Definition under Vol. 1.

### 3.2.5 Other cases requiring compartment walls and compartment floors.

The following situations shall require compartmentation by provision of compartment walls and/or compartment floors -

- (b) Any wall and floor separating part of a building from any other part of the same building which is used or intended to be used mainly for a purpose falling within a different purpose group, as identified under Table 1.2B, except the following:
  - (i) Ancillary offices located within a building or compartment of purpose group III.

- (ii) Rooms or spaces for ancillary usage located within a building or compartment of purpose group III as stipulated under cl.1.2.2(B).

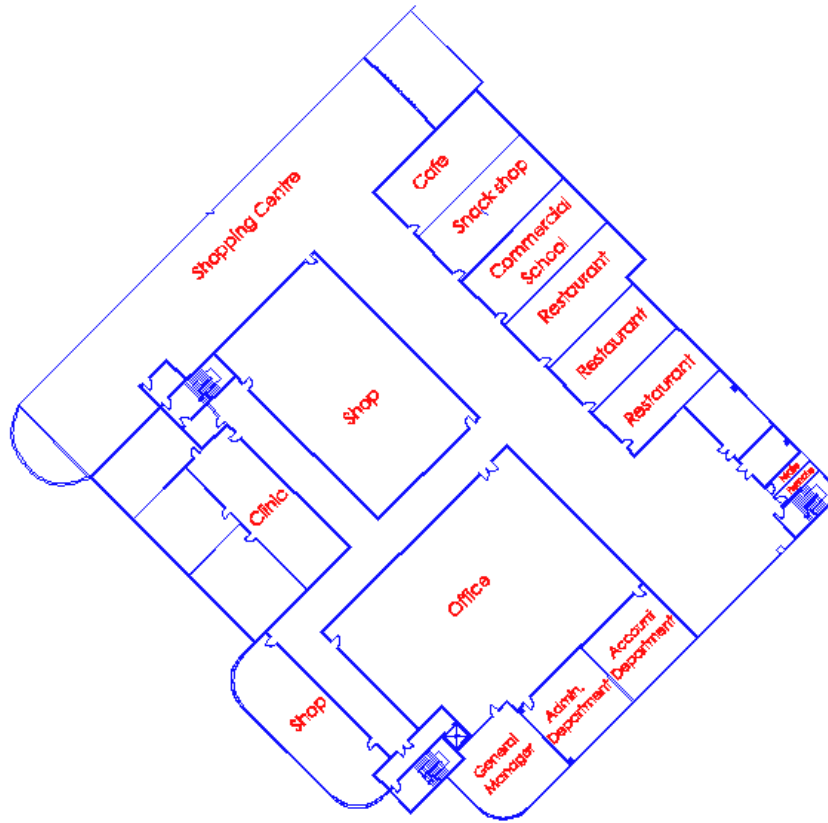

Diagram 3.2.5(b)

The above diagram shows a typical shopping floor, which has a mixture of uses of different purpose groups without fire compartmentation.

Strictly interpreting the above subclause would mean that in a shopping centre, for example, shop (Purpose Group V), office (Purpose Group IV), place of public resort (Purpose Group VII), commercial school (purpose Group III) would need to be separately compartmented from each other. This would not be practical. In practice, shopping or commercial buildings would have mixture of the uses of different purpose groups.

Under sub-clause (b)(i), an ancillary office which is located within the compartment or floor used as Purpose Group III is not required to be separately fire compartmented, provided the measurement of travel distance requirements of Purpose Group III shall apply to the ancillary office. Similarly, under sub-clause (b)(ii), ancillary usage to Purpose Group III such as sick/first aid room, reception lobby/area, waiting area, staff lounge/staff recreation room, staff rest room/pantry, staff changing/locker room, meeting room, staff training room, etc. is not required to be separately fire compartmented.

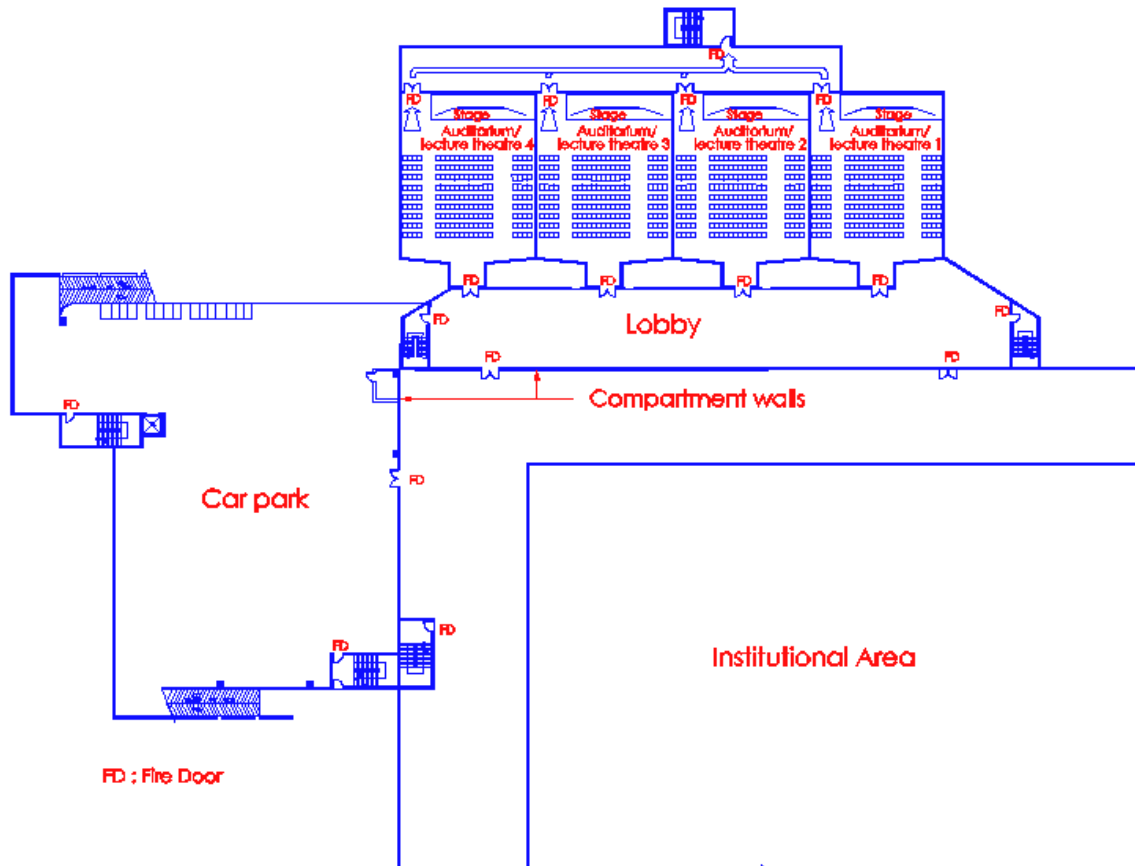

Diagram 3.2.5(b) –2

In the above diagram, the car park (Purpose Group VIII) is fire compartmented from the institutional area. The car park has higher fire risks than institutional area and auditorium. Fire separation between auditorium and institutional area is required. This is to safeguard the occupants in the auditorium from any fire occurrence in the institutional area.

### 3.2.5 (c) Floor over a basement

Any floor immediately over a basement storey if such storey -

- (i) forms part of a building or compartment of purpose group III; and
- (ii) has an area exceeding 100 m<sup>2</sup>.



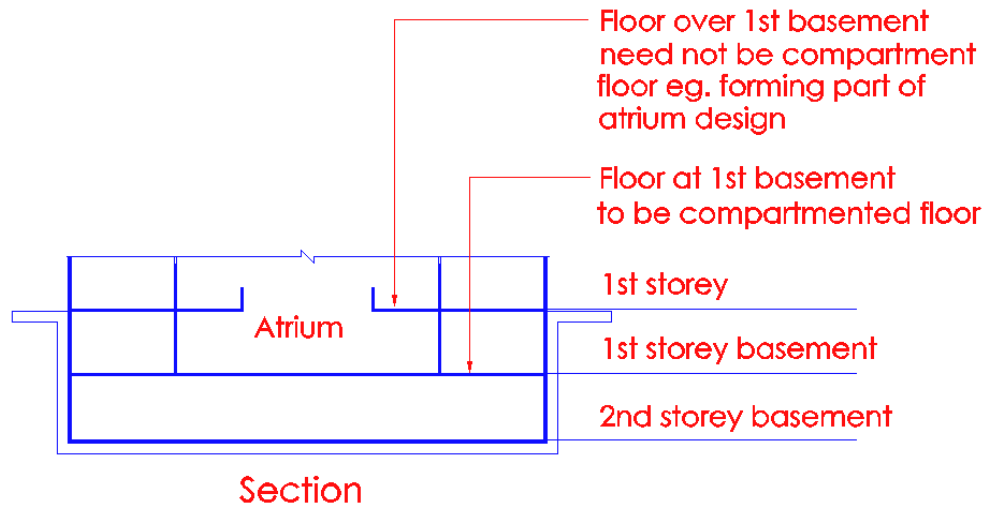

Diagram 3.2.5(c)(i)



Diagram 3.2.5(c)(ii)

Where the floor area of basement is less than 100m<sup>2</sup>, the floor over the basement need not be constructed as compartment floor. Openings can be created to connect the basement with upper storeys, subject to a maximum of 3 storeys or levels in a single compartment.

All basement floors, except those under Purpose Group I & II, are required to be provided with automatic sprinkler system under cl. 6.4.1(d)(i). Where basement floor, regardless of its area, is interconnected with upper storeys, the automatic sprinkler system required for the basement shall be extended to cover all the upper storeys.

### 3.5.2 Basement Floors

- (d) In any compartment below pavement level, no compartment shall comprise more than one storey. No part of a basement storey shall be used for the bulk storage of highly inflammable liquids or substances of an explosive nature.

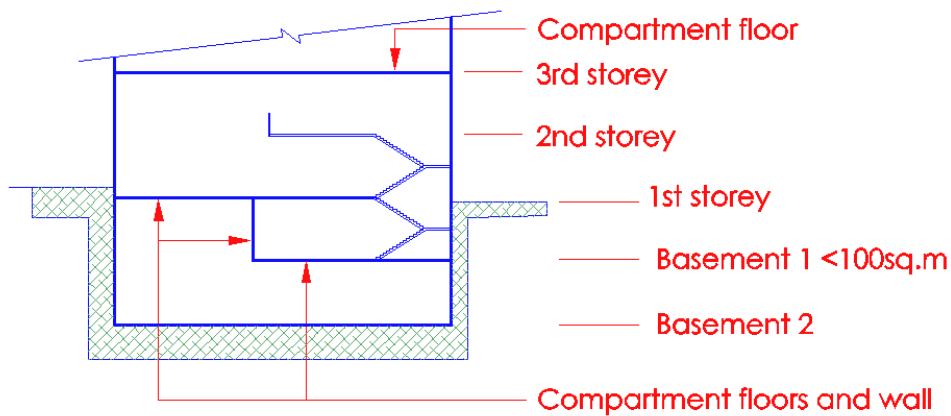

Diagram 3.2.5(d)- 1

Basement 1, which has a floor area of less than 100m<sup>2</sup> can be interconnected with 1<sup>st</sup> storey, provided it is compartmented from basement 2. Sprinkler system and rising mains are required to be provided to the building.

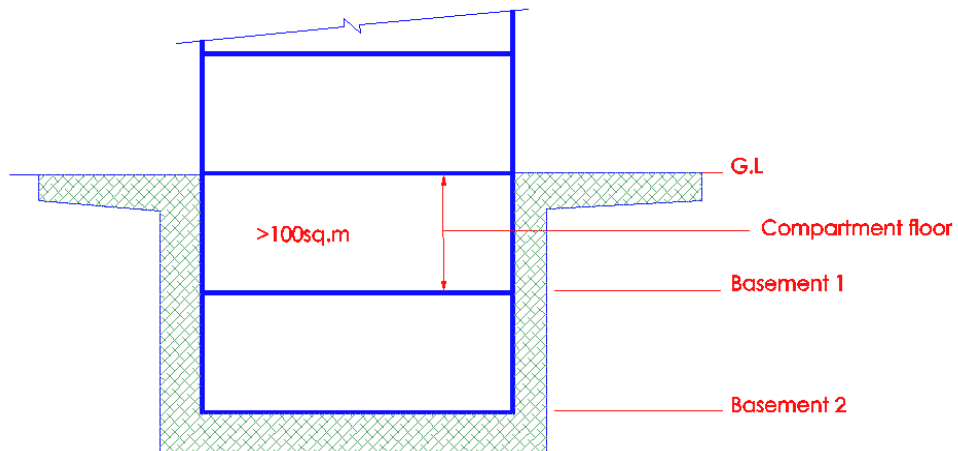

Diagram 3.2.5(d)- 2

Basement 1 having a floor area of more than 100m<sup>2</sup> is required to be compartmented from 1<sup>st</sup> storey. The above clause does not permit more than one basement storey per compartment unless solely used for car parking. Sprinkler system and rising main are required to be provided to basement.

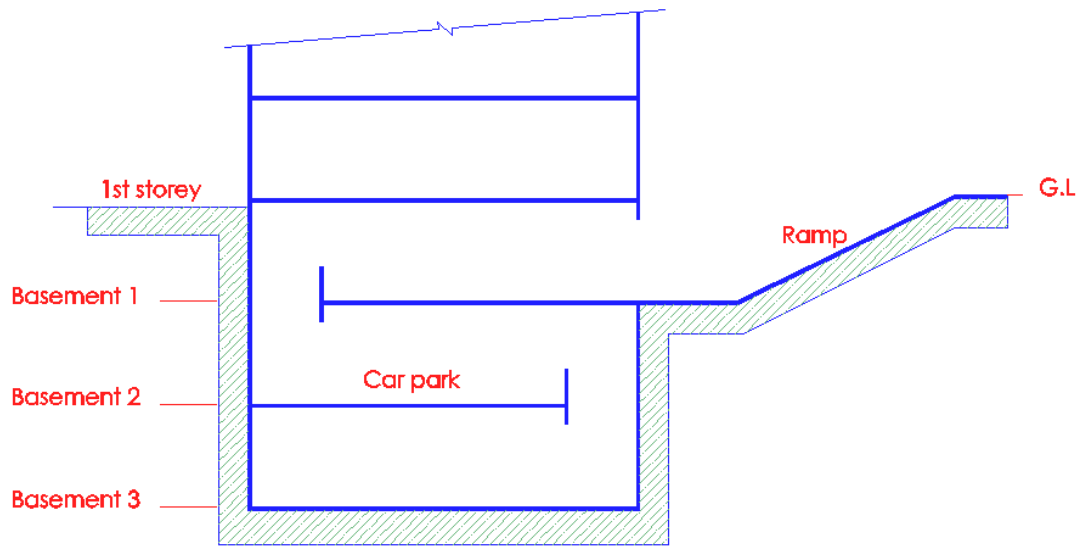

Diagram 3.2.5(d) – 3

Owing to the special use where ramps or car lifts are needed to connect all the car park floors, compartmentation is relaxed where sprinkler system and rising main are provided.

(e) Fire command centre

The fire command centre shall be separated from other parts of the same building by compartment walls and floors having fire resistance of at least 2 hours.

*(No illustration)*

*The fire resistance rating of the walls and floors shall comply with the elements of structure and shall have min. period of 2-hours. Any door opening into the Fire command centre from the occupancy area shall be min. 2-hours fire rated.*

(f) Kitchen Separation (Amended under Supplement 2/99 dated 25 May 99)

- (i) In an eating establishment where a kitchen is required for the preparation of food and/or where 'open flame' cooking appliances area used, the kitchen shall be separated from other parts of the same building by compartment wall and floor having fire resistance of at least 1 hour;

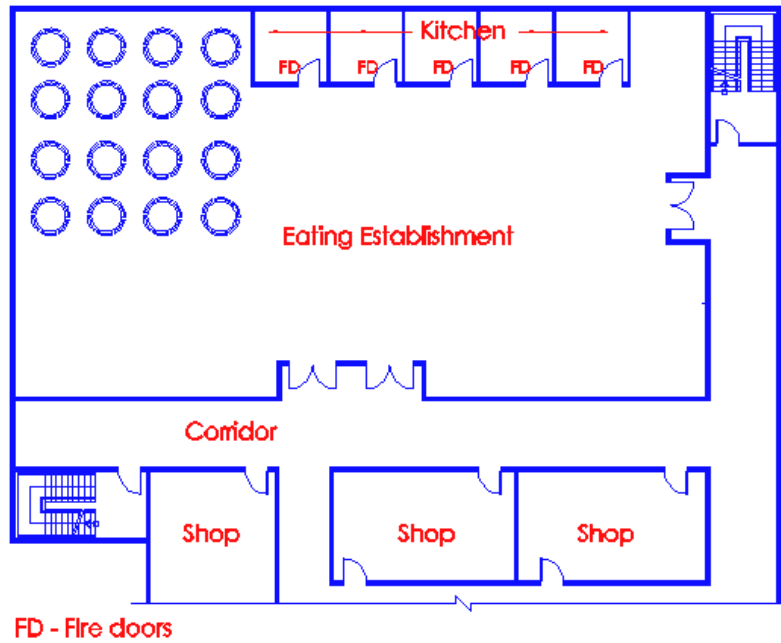

Diagram 3.2.5(f)(i)

The above diagram illustrates an eating establishment without kitchen fire-suppression system. The clause enables the QP to exercise the option of compartmenting kitchen with open-flame cooking.

- (ii) Openings in the compartment wall and floor shall comply with the relevant provisions of Cl.3.9 for protection of openings;
- (iii) Doors shall have fire resistance of half an hour and fitted with automatic self-closing device;

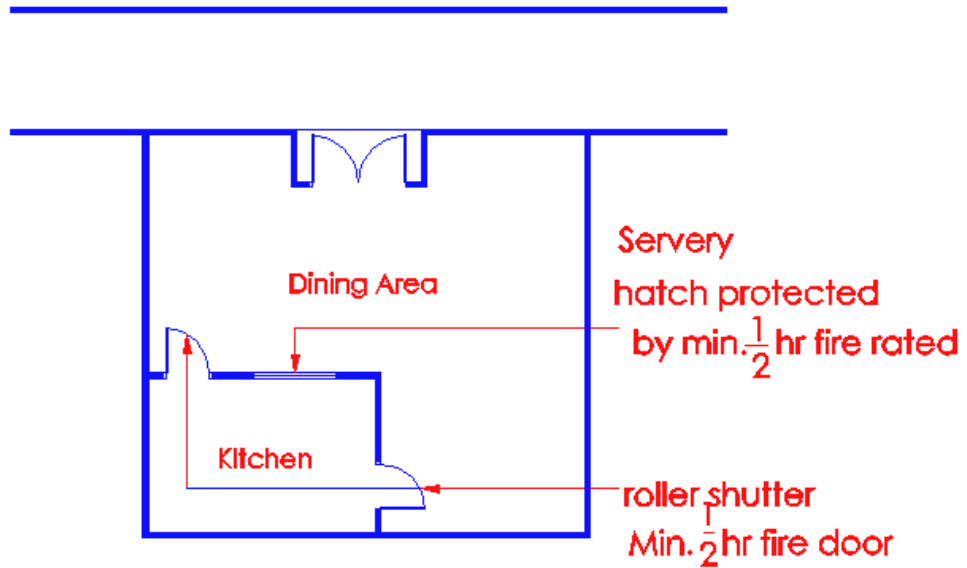

Diagram 3.2.5(f) - 1

Kitchen is compartmented from dining area by 1-hour enclosures and 1/2-hour fire doors. Protection to serving hatch can be a fire rated roller shutter held in the open position by fusible links.

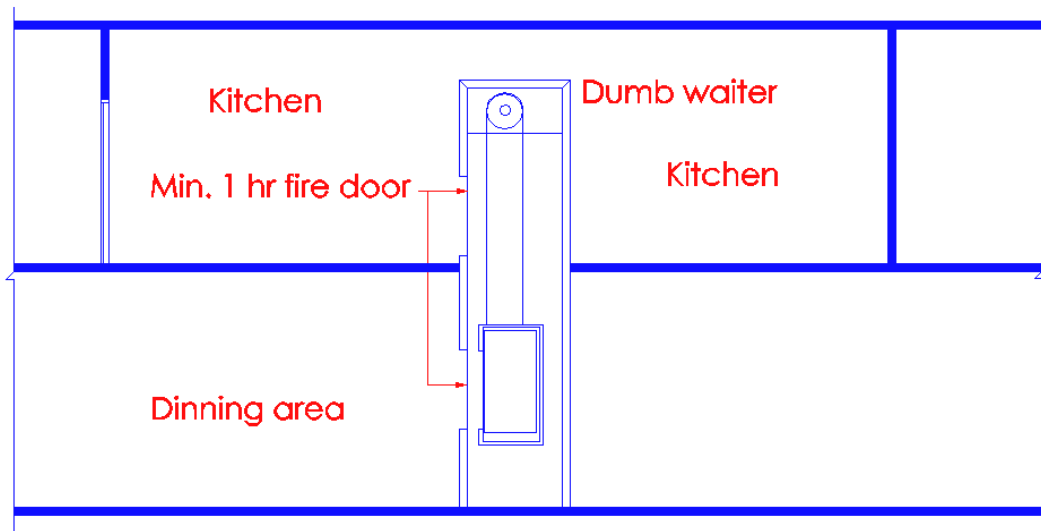

Diagram 3.2.5(f) - 2

As the dumb waiter is connecting 2 storeys, it shall be enclosed in 2-hours protective enclosures with 1-hour fire rated access door at each storey.

- (iv) Where the flue or duct passes through the compartment wall or floor, the flue or duct shall be encased by non-combustible construction to comply with the requirements of Cl.3.9.5 and no damper shall be permitted to be installed in such flue or duct; and

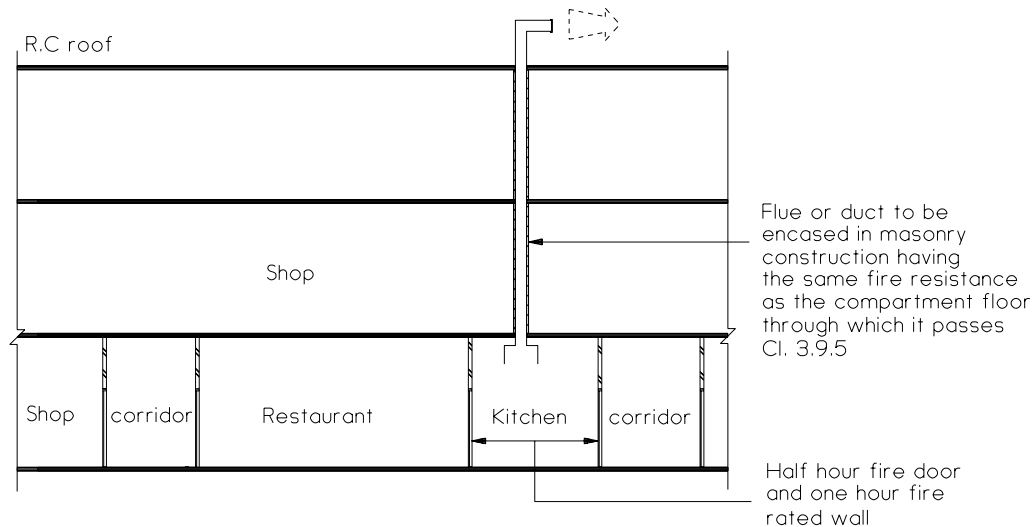

Diagram 3.2.5(f)(iv)

*Kitchen is required to be compartmented from other areas by 1-hour compartment walls and floors. Doors to the kitchen shall have minimum ½-hour fire resistance rating and shall open outward from the kitchen. Small fire which commonly occur in the kitchen are often caused by overheating of cooking oil on the stove or in a deep pan fryer or by grill. Exhaust ducts in kitchen are usually coated with grease internally over a period of time. Fire in the ducts could be started by sparks or by fire from the stove.*

*Cooking appliances include – open flame gas fired oven, charcoal grill and appliances which have open flames located or protected from views.*

*Fire rated door to kitchen shall not be wedged open for serving purpose. In circumstances where fire doors are to be kept open, the door shall be fitted with electro-mechanical device susceptible to smoke under Cl.3.9.2(c). See cl.1.2.20 of Volume 1 for further illustration.*

*To qualify for non-provision of fire compartment under sub-clause (v), auto fire suppression equipment should be incorporated into the cooking range. This equipment may consist of fixed piped carbon dioxide, dry chemical or foam-water sprinkler or spray system. Such auto suppression system to the cooking range shall be of the approved type under the PSB Product Listing Scheme and bear PSB label or mark.*

(v) Separation requirement for kitchen could be exempted under the following conditions:-

(a) when all the cooking facilities in the kitchen are fitted with approved extinguishing systems; or

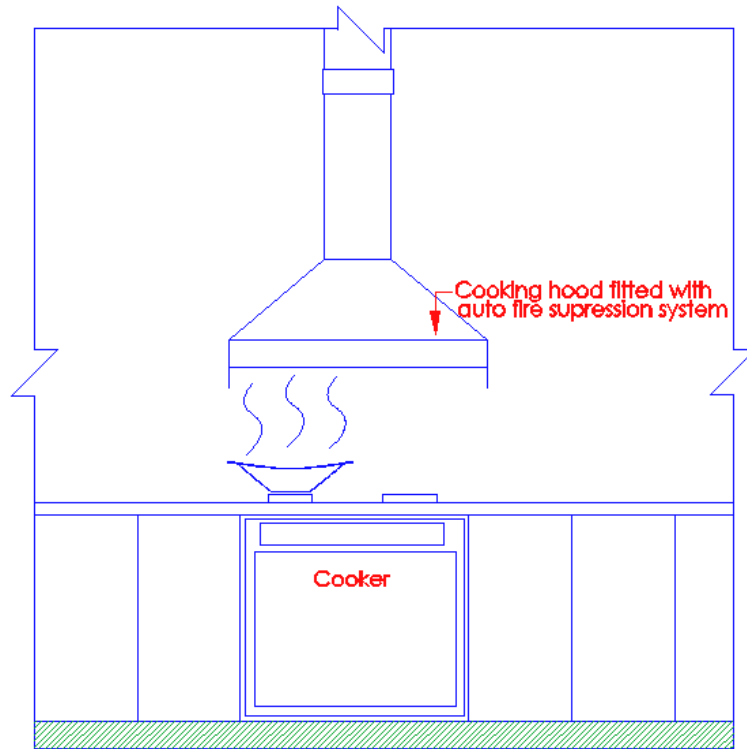

Drawing3 .2.5(f)(a)

*The above sub clause allows the kitchen not to be compartmented if the cooking hood or range is installed with an automatic fire suppression system, bearing PSB Label.*

*With this arrangement, there is no need to seek waiver approval from SCDF (FSSD).*

(b) when there are at least 25% of the perimeter walls (excluding air-well and void) of an eating establishment open directly to the external of the building, and provided any part of the floor space is within 9m from the nearest opening; or

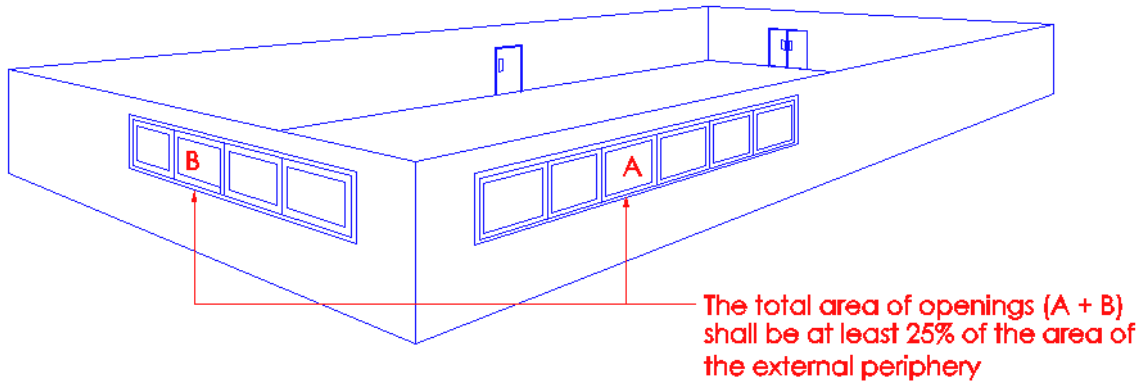

Diagram 3.2.5(f)(v)(b)- 1

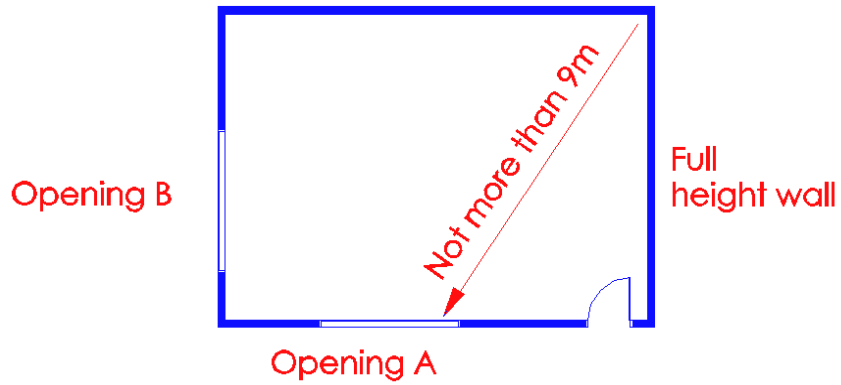

Diagram 3.2.5(f)(v)(b) – 2

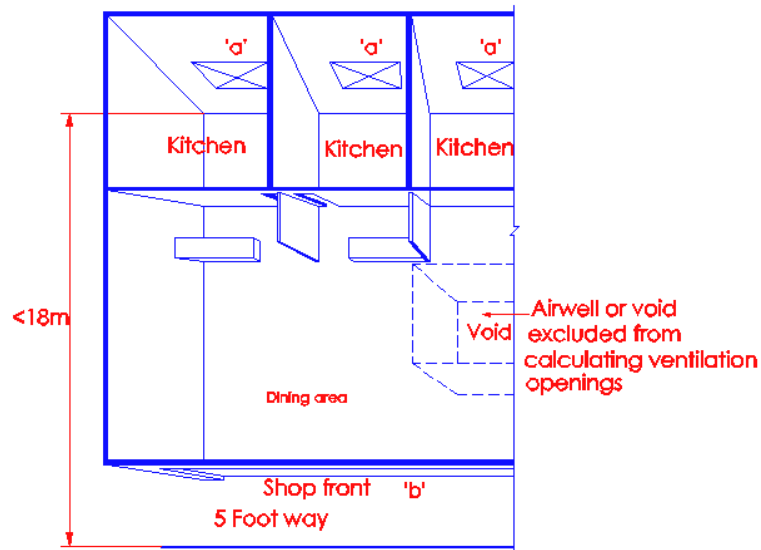
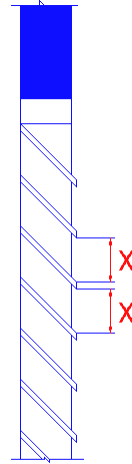

Diagram 3.2.5(f)(v)(b) - 3





Section view of fixed louvre window

*In the above situation, kitchens are not required to be compartmented. Total ventilation openings provided along the external walls of 'a' and 'b' shall have minimum 25% of the floor area of kitchen and dining. No part of the floor space shall be more than 9m from the external openings. The openings referred to in walls 'a' and 'b' shall be unobstructed vertical openings for the passage of light and air, for example, in the case of fixed louvres, the net ventilation opening between over-lapping louvres is 'x' as given in the above sectional drawing.*

- (c) when there are at least 50% of the perimeter walls (excluding air-well and void) of an eating establishment open directly to the external of the building, and provided any part of the floor space is within 12m from the nearest opening; or

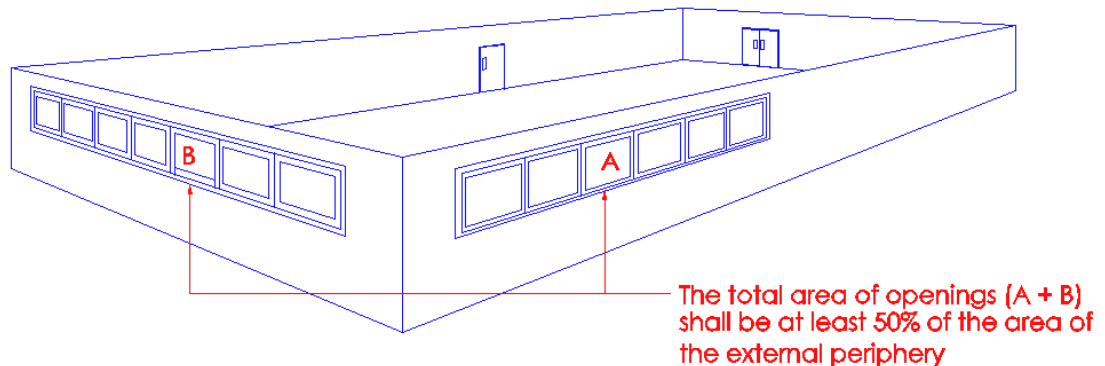

Diagram 3.2.5(f)(v)(c) – 1

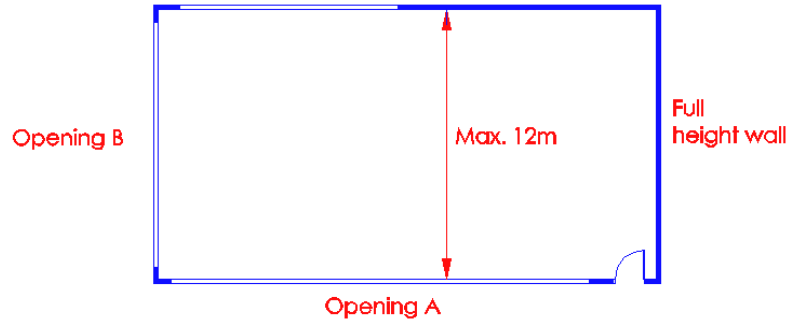
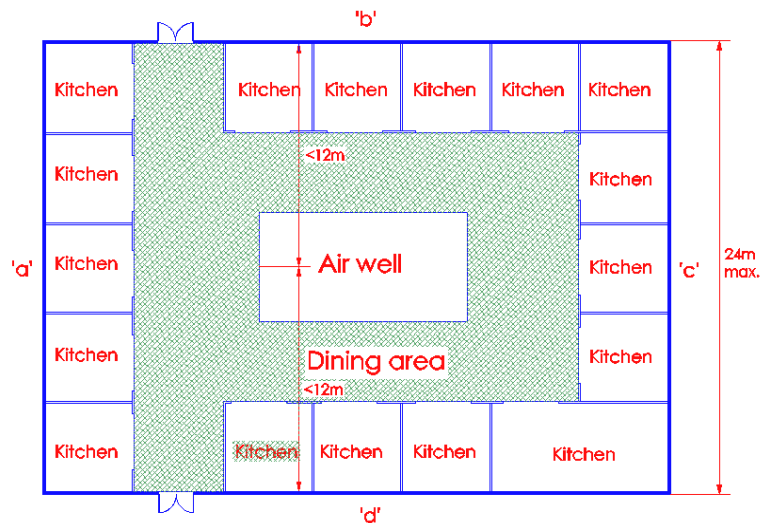

Diagram 3.2.5(f)(v)(c) – 2

The 25% and 50% ventilation openings are required for smoke venting and relief of accumulated heat from the area on fire. This exemption cannot be applied in an enclosed air-conditioned environment, where the peripheral walls are fitted with glass panel.

The 25% and 50% ventilation openings are absolute values. Extrapolation of percentage ventilation openings based on depth of the eating establishment is not permitted.



Drawing 3.2.5(f)(v)(c) – 3

In the above diagram the kitchens are not required to be compartmented.

Ventilation openings along the external walls 'a', 'b', 'c' and 'd' shall be uninterrupted, having minimum 50% of the perimeter walls of the eating establishment. The openings to the air well shall not be included in this purpose.

The above requirement is more relevant to hawker centre type design.

- 3.2.5 (f) (v) (d) when an eating establishment is separated from other parts of the same building by walls and floors having fire resistance of at least 1 hour and doors having fire resistance of at least half an hour; and provided –
- (i) for a sprinkler protected building, there is no need to control the floor area of the compartment; or

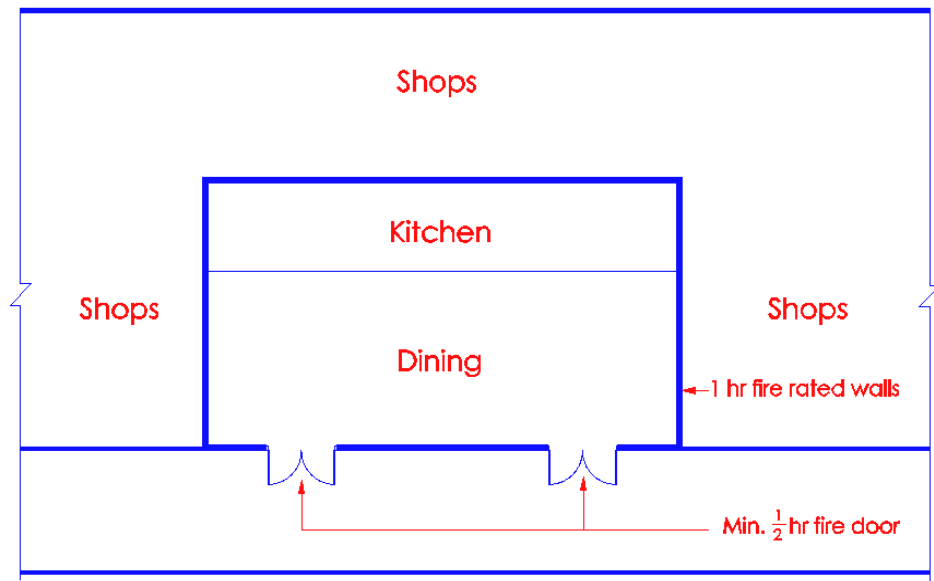

Drawing 3.2.5(f)(v)(d)(i) – 1

*Under subclause d(i), the kitchen and dining area can be in one compartment, provided the building is sprinkler protected and the floor area of the compartment does not exceed 600m<sup>2</sup>.*

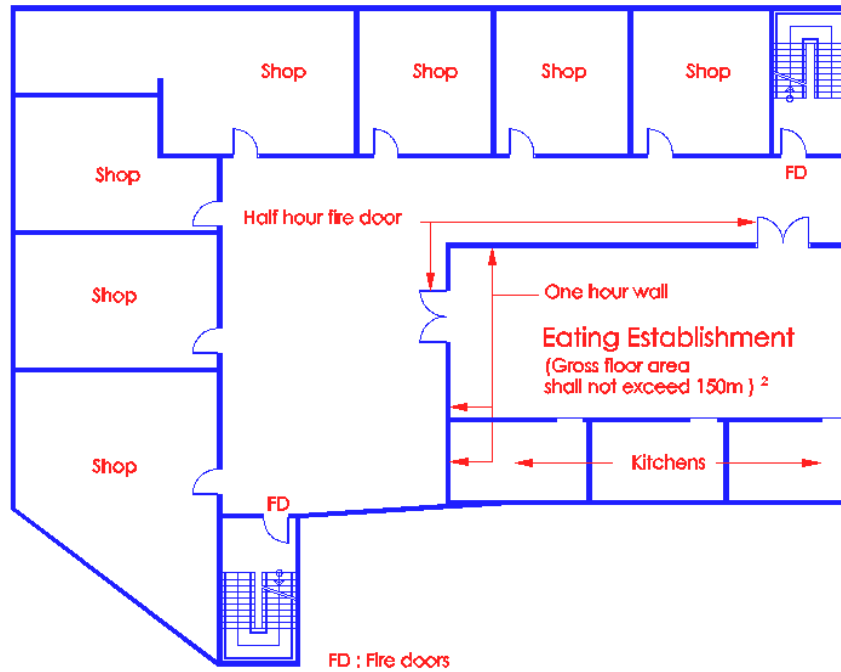
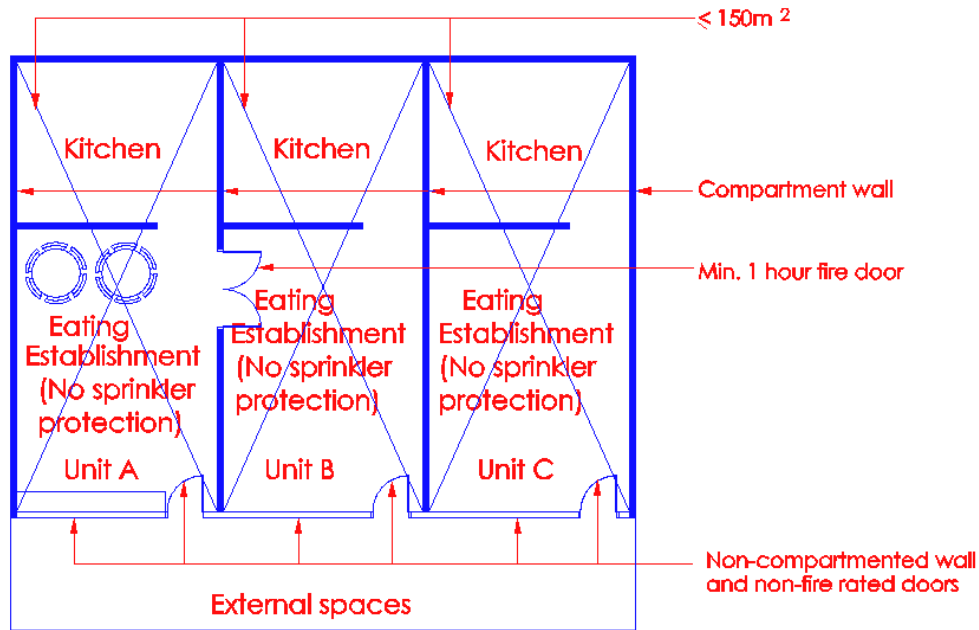

Diagram 3.2.5(f)(v)(d)(l) – 2

With the provision of sprinkler system, further relaxation is allowed to permit the whole eating establishment to be enclosed with at least 1 hour fire rated walls and  $\frac{1}{2}$  hour fire rated door subject to the maximum gross floor area of  $600\text{m}^2$ .

- (ii) for a non-sprinkler protected building, the floor area of the compartment shall not exceed  $150\text{m}^2$ ;



Drawing 3.2.5(f)(v)(d)(ii) – 1

Under sub clause d(ii) where the building is not sprinkler protected, the area of the compartment, kitchen and dining area e.g (unit A) shall not exceed 150m<sup>2</sup>.

LPG cylinders provided for the 'open flame' cooking activities are not allowed to be located at the basement and the installation of LPG cylinders at other areas shall comply with provisions in the Fire Safety (Petroleum) Regulations.

Notwithstanding all the above, the compartment where 'open flame' cooking activities is carried out shall not comprise more than one storey.

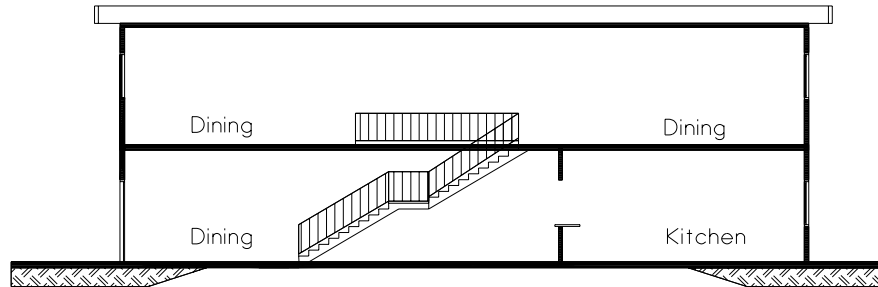

Drawing 3.2.5(f)(v)(d)(ii) – 3

Where 'open flame' cooking is used, the compartment comprising dining and kitchen areas shall not comprise more than one storey, notwithstanding the following :-

- (a) building is sprinkler protected and the compartment does not exceed 600m<sup>2</sup>; or
- (b) Building is not sprinkler protected and the compartment does not exceed 150m<sup>2</sup>.

LPG cylinders shall not be used in any basement storey. However, piped gas is permitted in basement storeys.

In the case of eating establishment which comprises 2 storeys, then each storey shall be a fire compartment by itself.

Clauses 3.2.5(g) and (h) excluded

### 3.2.5 (j) Workers' dormitories

- (i) Each dormitory bedroom shall be compartmented from adjoining rooms and other parts of the same building by construction having fire resistance rating of at least 1-hour, unless otherwise permitted under cl.2.9.4 for the provision of window openings between the bedroom and external corridor;

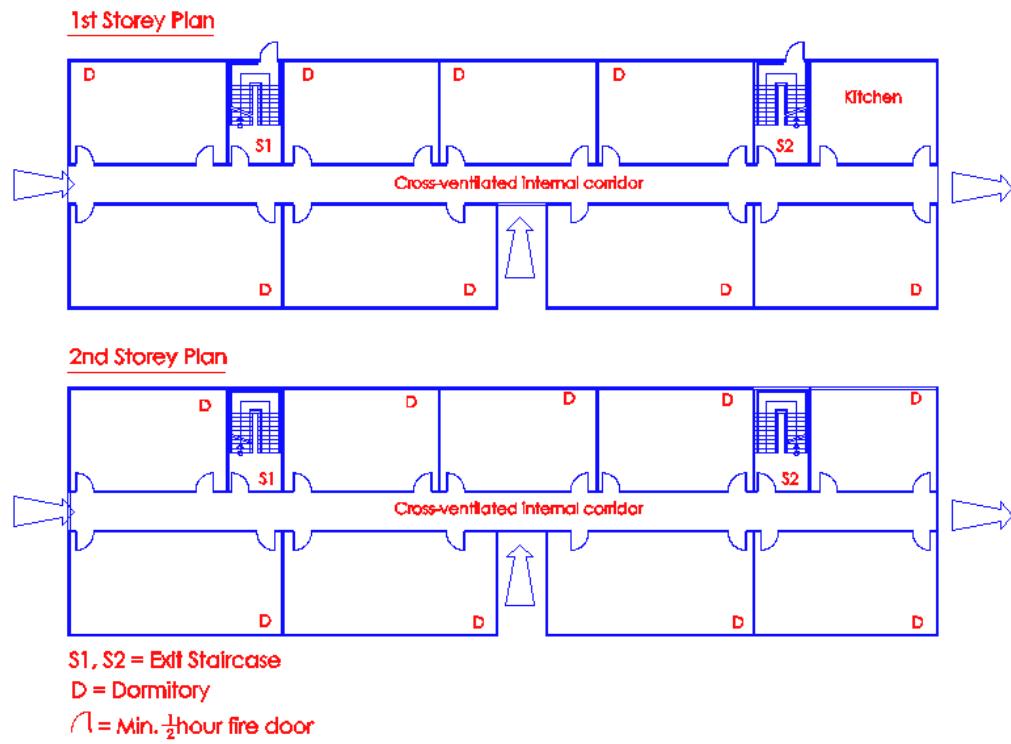

Diagram 3.2.5(j)(i)-1

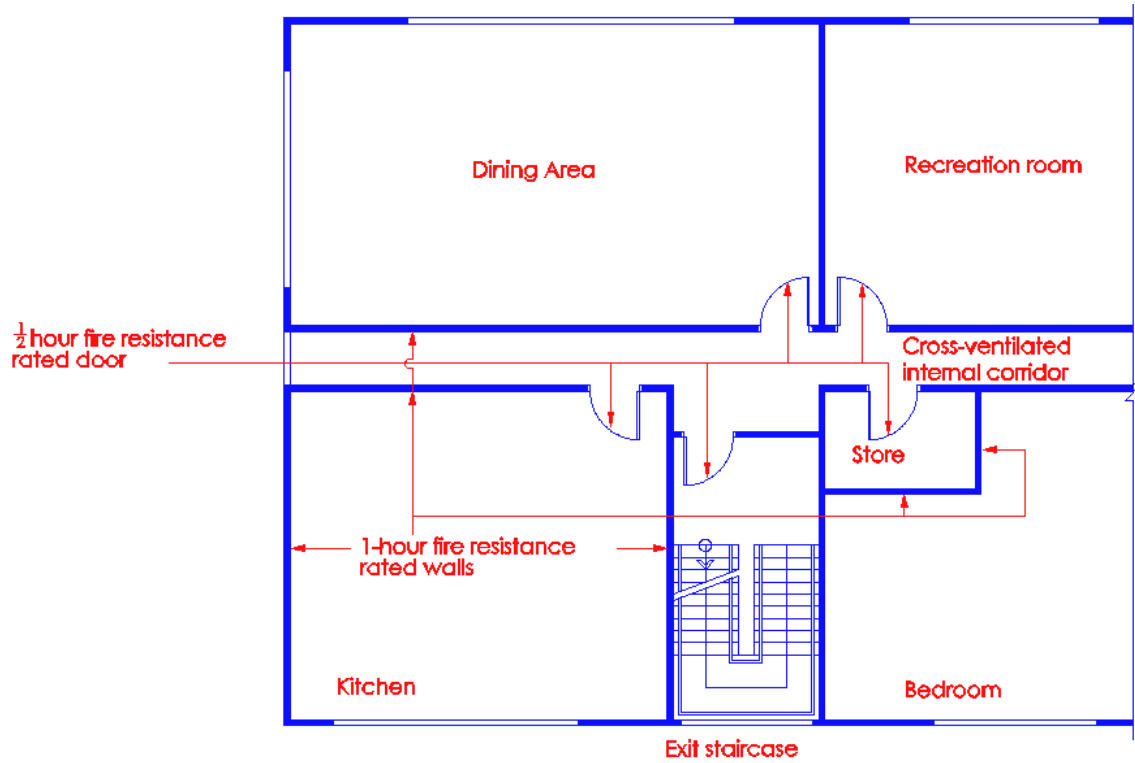
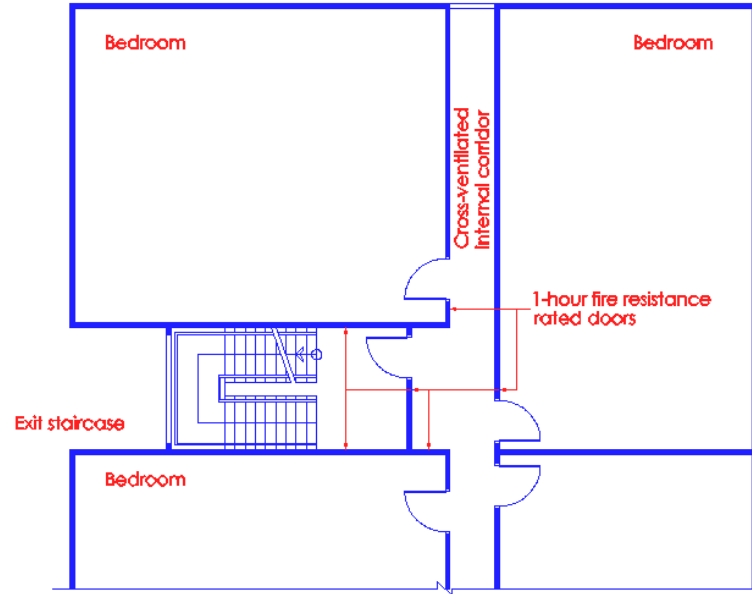

Diagram 3.2.5(j)(i)-2

- (ii) Dormitory bedrooms and other rooms or spaces which open into or from part of the dormitory bedroom corridor shall be separated from the corridor to comply with cl.2.9.3 and cl.2.9.4; and



 = 1/2 hour fire resistance rated doors

Diagram 3.2.5(j)(ii)-1

Ventilation of internal corridors to worker's dormitory

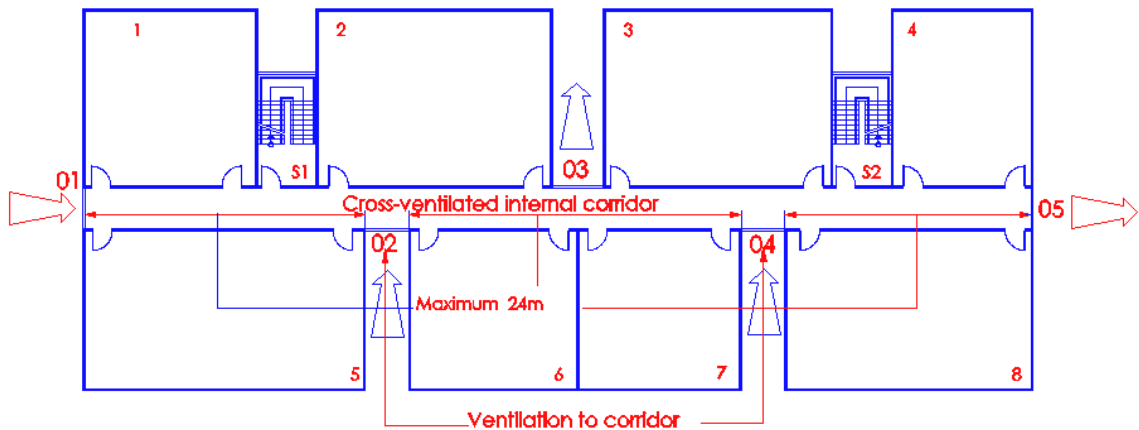

S1, S2 = Exit Staircase

O1 - O5 = Openings to internal corridor for natural ventilation

Diagram 3.2.5(j)(ii)-2



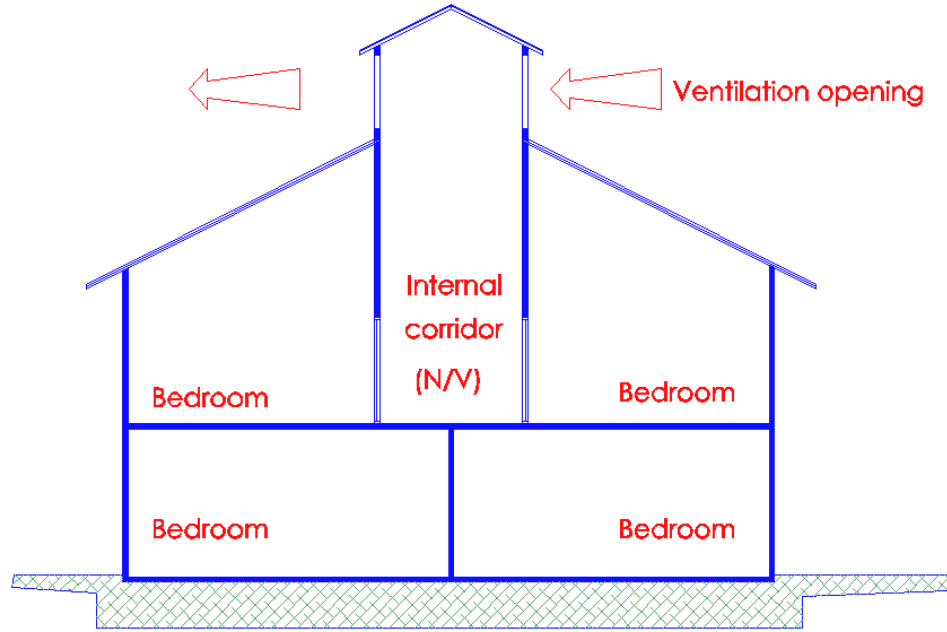

Diagram 3.2.5(j) (ii)-3

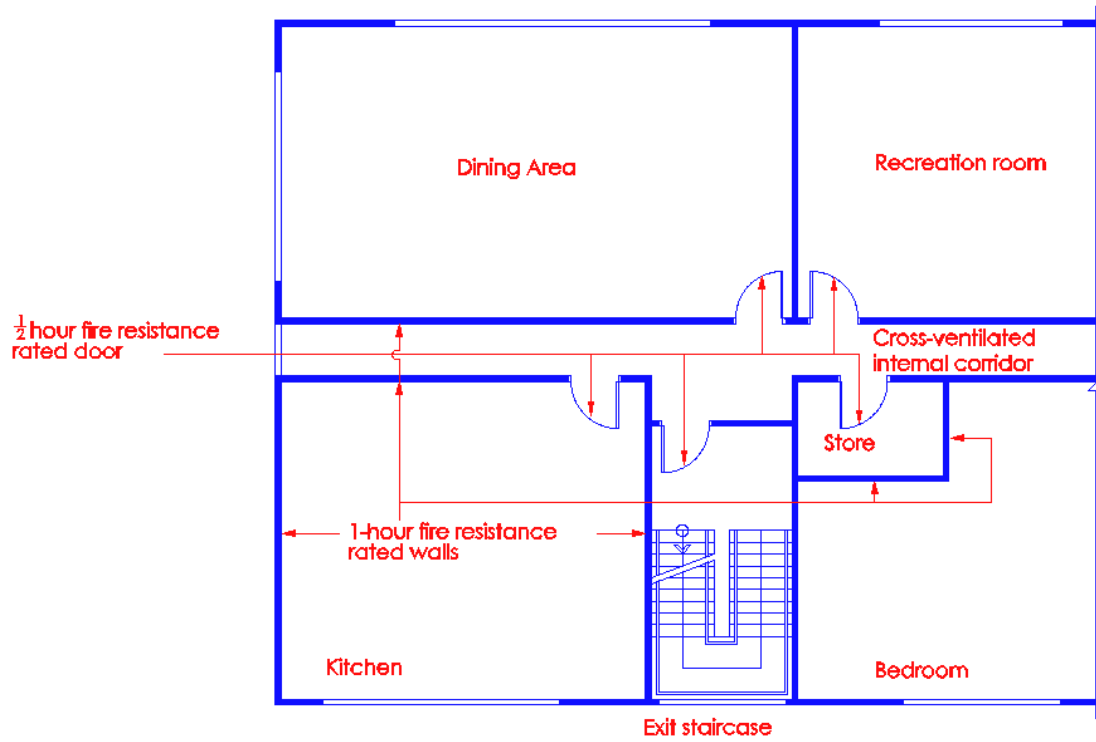

Diagram 3.2.5(j)(ii)-4

- (iii) Kitchen shall be enclosed with minimum 1-hour fire rated compartment wall, including ½-hour fire rated door. Kitchen can be located within each floor, but shall not be within the dormitory bedroom.

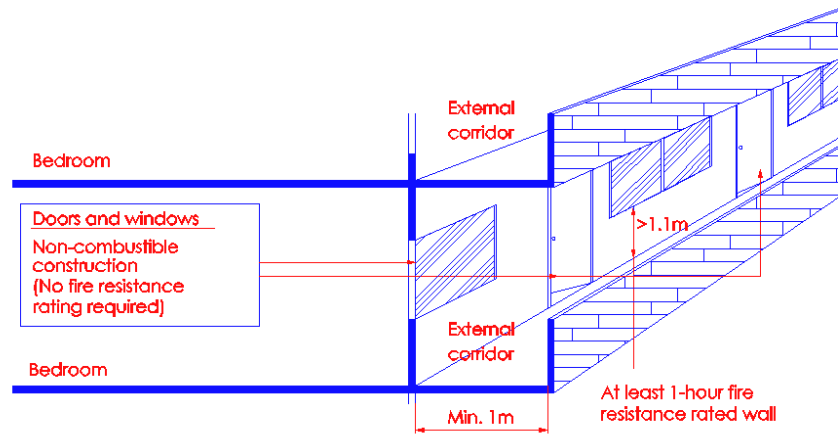

Diagram 3.2.5(j)(iii)

### 3.2.5 (m) Coldroom

- (i) Where a coldroom has a floor area exceeding 10 sq m, a separate outer layer of non-combustible construction, including the door, having minimum 1-hour fire resistance rating, shall be provided to compartmentalise the coldroom enclosure from other areas.

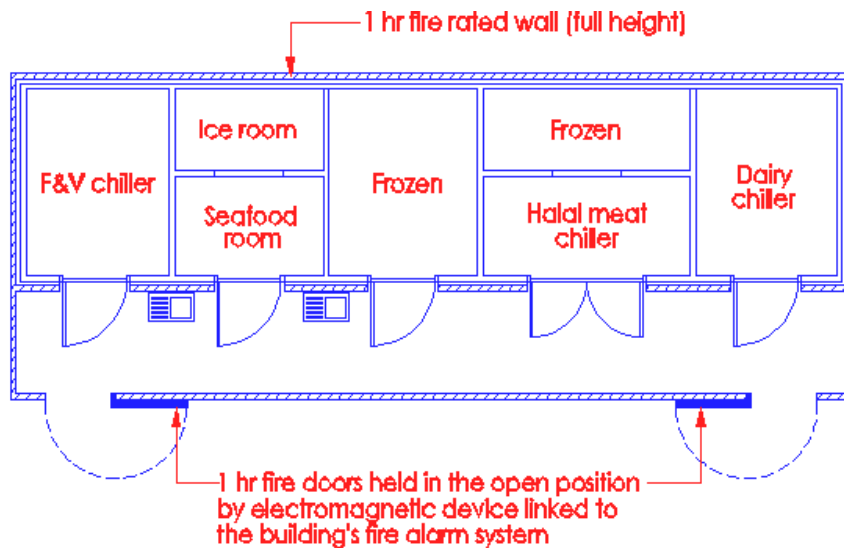

Diagram 3.2.5(m)-1

The main concern about coldrooms is the use of combustible insulation materials for the construction of the coldroom walls, ceilings and floors. The insulation material is usually polystyrene or polyurethane which when subject to a fire would burn vigorously to release great amount of heat and thick poisonous fumes.

The above diagram illustrates a cluster of coldrooms in a food processing factory, which is sprinklered protected. The aggregate floor area of the coldrooms is more than 20 sq m. Hence, the provision of 1-hour fire rated outer skin of compartment walls and doors would be necessary.

### 3.2.5 (n) Store room (Amended under Supplement 6/99 dated 31 Dec 99)

For non-sprinklered buildings, if the area of the store room exceeds 10m<sup>2</sup>, it shall be compartmented from the other parts of the same building by compartment walls and compartment floors having fire resistance of not less than 1 hour. No fire compartmentation is required for a store room which is housed within a sprinklered building.

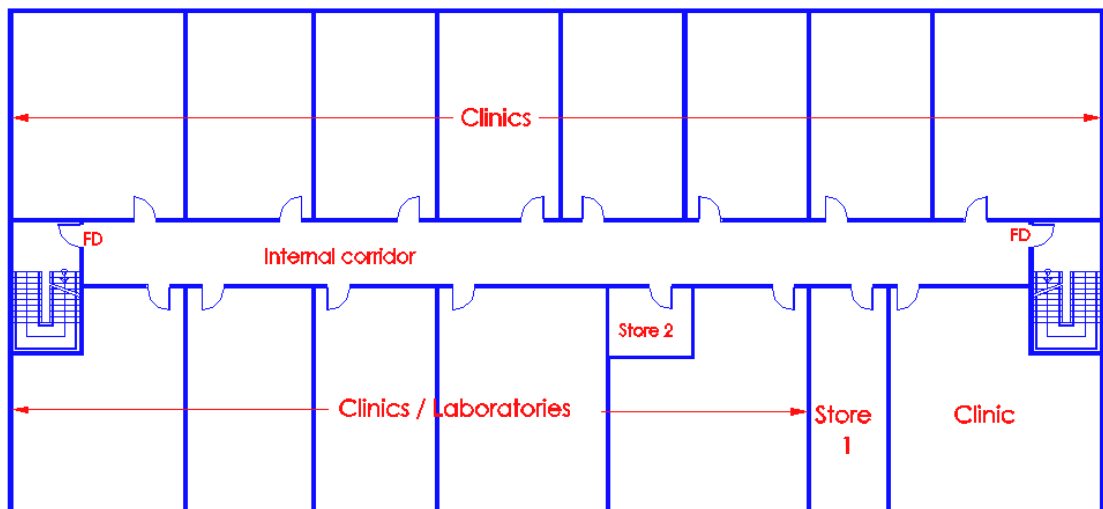

Diagram 3.2.5(n)

Store 1 exceeding 10m<sup>2</sup> inside a health-care occupancy floor will need to be compartmentalised with 1- hour fire rated enclosures, unless the floor is protected by sprinkler system.

Store 2 which is less than 10m<sup>2</sup> is not required to be provided with fire door and 1-hour enclosures.

The main reason for compartmentation of storeroom >10m<sup>2</sup> in non-sprinklered buildings is to prevent undetected fire in the storeroom from developing into a big fire.

### Compactus

Compactus room which is more than 10m<sup>2</sup> shall be treated as a compartment in non-sprinklered buildings under the above subclause. The enclosing walls/floor/ceiling/door shall have min. 1 hour fire resistance rating. Irrespective of the location of the compactus storage area, if it is not enclosed in a room, it shall be treated as open storage shelves and not as a store. The main reason is that a fire occurring in a room could be unnoticed, until it becomes too big to be put out by first aid fire fighting equipment. An incipient fire occurring in an unenclosed compactus storage area could be easily spotted by occupants and immediate reaction could be taken to put out the fire.

Any store, regardless of its size, shall be compartmented, if it opens directly into exit passageways and designated protected escape routes, eg. smoke stop lobbies, protected staircases.

#### (o) Areas of Special Hazard

##### (i) Areas of special high risk in a building

Boiler rooms, transformer rooms, generator rooms, storage areas of materials that are highly combustible or flammable, and any other area of special high risk shall be separated from other parts of the building by compartment walls and floors having fire resistance of not less than 2 hours. If the building is protected by an automatic sprinkler system, the fire resistance rating of the compartment walls and floors can be reduced to 1 hour.

##### (ii) Rooms housing transformer containing flammable liquid and generator rooms shall be located against an external wall. (No illustration)

#### Transformer room

Transformers could be dry type or oil cooled type. Oil cooled type are to be located against an external wall above ground level to allow for external ventilation and explosion relief. Adequate precautions should be taken by providing catch pit or other means to contain any possible leakage of oil. This would help to contain a fire should there be an outbreak of oil fire in the pit.

#### Generator rooms

Generator sets shall be located in clean, dry locations having 4-hours fire compartments. They may be placed outdoors if they are of purpose built type, provided proper separation from unprotected openings of the building is maintained. Generator rooms shall have an external wall above ground level to allow for external ventilation and explosion relief.

### Storage areas of highly combustible or flammable materials

Where possible, oil storage tanks should be installed in open air at ground level at least 6m from adjacent buildings and in accordance with CP 40. A max. capacity of 700 litres of diesel oil is permitted to be stored in the generator room. The oil drum/s shall be located within a bunded area, capable of containing 100% spillage from the drum(s).

Prior approval is to be obtained from SCDF (FSSD) for storage of combustible or flammable liquids, other than in the generator room, before building plan submission.

### 3.2.6 Provision for atrium spaces

The Relevant Authority may consent to modify the requirements under Cl.3.2.1 and 3.2.4(a) and (b) of this Code for the design of "Atrium spaces" in a building provided the following conditions are complied with :

- (a) The minimum plan area of the Atrium void shall be not less than 93m<sup>2</sup> and no horizontal dimension between opposite edges of the floor opening is less than 6m wide; and
- (b) Occupancy within the floor space of the Atrium meets with the specification for low or ordinary hazard content; and
- (c) The atrium is open and unobstructed in a manner such that it may be assumed that a fire in any part of the space will be readily obvious to the occupants before it becomes a hazard; and
- (d) The building is fitted throughout with an automatic sprinkler system to comply with the requirements in Chapter 6; and
- (e) The building is fitted with an engineered smoke control system in accordance with cl.7.6; and
- (f) Provision of openings and enclosures, and the planning of means of escape shall be subject to the approval of the Relevant Authority.

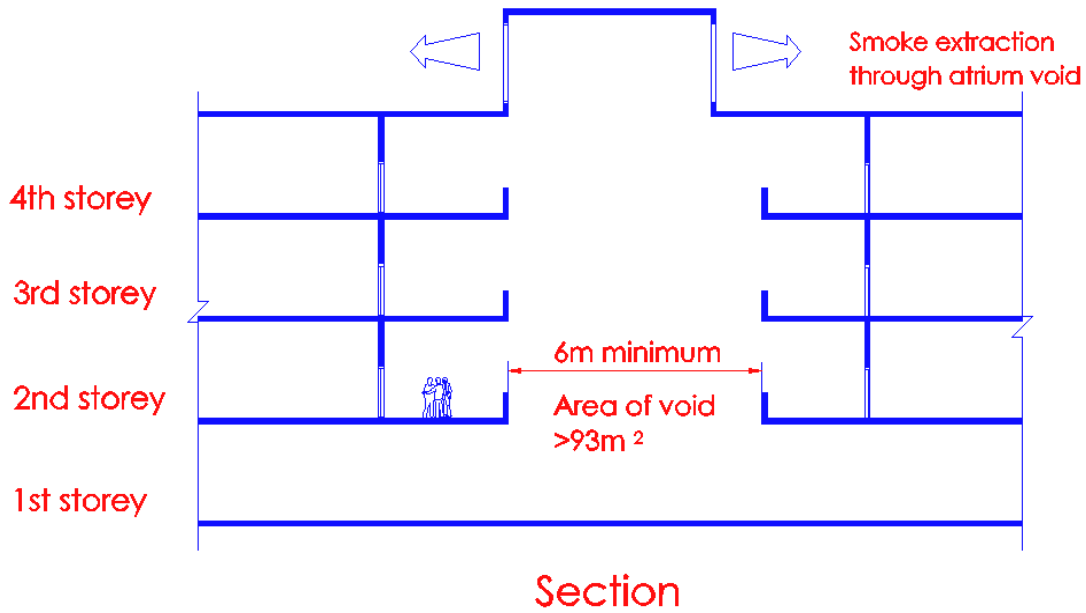

Diagram 3.2.6

- (i) The above clause allows the SCDF (FSSD) to vary the max. floor area/cubical extent of fire compartment to allow more than 3 storeys to be interconnected. The critical points for consideration would include the size and configuration of atrium void and the provision of sprinkler system and engineered smoke control system.
- (ii) QPs should consult SCDF (FSSD) in all cases of atrium designs before making building plan submission. The vetting will confine only to looking at the concept and the layout and profile of atrium void in the building proposal only. Calculations for the engineered smoke control system shall be submitted separately by M&E qualified persons.
- (iii) Where a compartment in a building has a total floor area and cubical extent greater than that allowed under Table 3.2A, but the number of floor interconnected by void does not exceed 3 floors, Qps should consult SCDF (FSSD) whether there is a need to provide engineered smoke control system, before making building plan submission. Similarly, if a compartment in a building has a total floor area and cubical extent greater than that allowed under Table 3.2A and the number of floor interconnected by void is more than 3 floors, Qps should consult SCDF (FSSD) before making building plan submission. The consultation would confine to vetting of requirements mentioned in subclause (ii) above.

Clause 3.2.8 is excluded.

### 3.3 FIRE RESISTANCE OF ELEMENTS OF STRUCTURE

#### 3.3.1 Minimum periods of fire resistance

Subject to an expressed provision to the contrary, any element of structure shall be constructed of non-combustible materials (excluding materials of limited combustibility) and to have fire resistance for not less than the relevant period specified in Table 3.3A having regard to the purpose group of the building of which it forms a part and the dimensions specified in that Table, provided that –

- (a) Any separating wall shall have fire resistance of not less than 1-hour, and

(No illustration)

*The main intention of the above subclause is to spell out the min. period of fire resistance rating for separating wall ie. 1-hour although the period specified in Table 3.3A could be ½-hour for elements of structure for small and low-rise buildings under Purpose groups (IV), (v) and (VII). If the period of fire resistance specified in Table 3.3A is more than 1-hour for elements of structure, then this period shall be made applicable to the separating wall.*

- (b) Any compartment wall or compartment floor which separates a part of a building falling within purpose group III from any other part of the building falling within a purpose group other than purpose group III shall have fire resistance of not less than 1-hour.

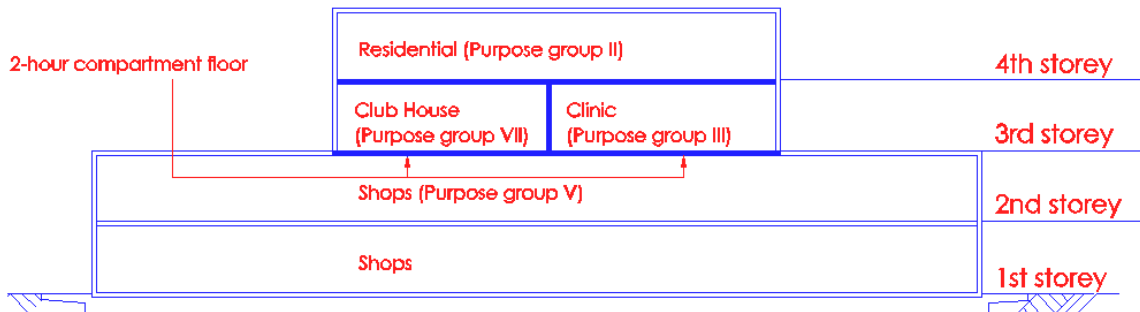

### Section

Diagram 3.3.1 (b)

Fire resistance of compartment floors

- i) The compartment floor between residential (purpose group II) and club house (purpose group VII) shall have min. 1-hour fire resistance rating.
- ii) The compartment floor between clinic (purpose group III) and shops below (purpose group V) shall have min. 1-hour fire resistance rating
- iii) The compartment floor between club house/clinic and shops below shall have min. 1-hour fire rating. If the shops require 2-hour fire resistance rating, then this rating shall be applied to the compartment floor (3<sup>rd</sup> storey).

Fire resistance of compartment wall

The compartment wall that separates club house from clinic shall have fire resistance of not less than the relevant period specified in Table 3.3A, but shall not be less than 1-hour.

TABLE 3.3A  
(Minimum periods of fire resistance)

In this Table –

“cubical extent” means the cubical extent of the building or, if the building is divided into compartments, the compartment of which the elements of structure form part;

“floor area” means the floor area of each storey in the building or, if the building is divided into compartments, of each storey in the compartment of which the element of structure forms part;

“height” has the meaning assigned to that expression by CL 3.3.4(b)

“NL” means No Limit applicable.

Any element of structure shall be so constructed as to have fire resistance for not less than the relevant period specified in Table 3.3A.

“Notes to Part I”, below the Table 3.3A, summarises how the Table is applied in determining the required period of fire resistance for a building under Purpose Group VI and VIII. The ‘lines’ mentioned refers to the categories or subgroups of buildings under the same Purpose Group as shown below:



PART I

BUILDINGS OTHER THAN SINGLE STOREY BUILDINGS

Purpose Group  (1)	Maximum dimensions			Minimum period of fire resistance (in hours) for elements of structure (*) forming part of-	
	Height (in m)  (2)	Floor area (in m <sup>2</sup> )  (3)	Cubical Extent (in m <sup>3</sup> )  (4)	Ground storey or upper storey  (5)	Basement storey  (6)
III (Institutional) (Line 1) (Line 2)	28 Over 28	2,000 2,000	NL NL	1 1½	1½ 2

Notes to Part I

For the purpose of Cl.3.3.1 the period of fire resistance to be taken as being

relevant to an element of structure is the period included in columns (5) or (6) in the line of entries which specifies the floor area with which there is conformity or, if there are two or more such lines, in the topmost of those lines.

- (\*) A floor which is immediately over a basement storey shall be deemed to be an element of structure forming part of a basement storey
- (+) The expression 'part' means a part which is separated as described in Cl.3.3.4(b)
  - (a) The period is half an hour for elements forming part of a basement storey which has an area not exceeding 50m<sup>2</sup>
  - (b) This period is reduced to half an hour in respect of a floor which is not a compartment floor, except as to the beams which support the floor or any part of the floor which contributes to the structural support of the building as a whole.
  - (c) This period is reduced to 2-hours for open-sided buildings which are used solely for carparking.

Please note that the above notes (+), (a), (b) & (c) are not applicable to institutional buildings.

Two buildings with the following configurations are used as examples to explain how their periods of fire resistance can be determined.

Building configurations (Institutional)	Height (m)	Floor area (m <sup>2</sup> )	Cubicle extent (m <sup>3</sup> )	Above ground	Basement
Building A	<28	2000	NL	1	1½
Building B	>28	2000	NIL	1½	2

Example 1 (Building A)

Line 1 of the Table 3.3A, Part I would be applicable since the building A does not exceed 28m in height. Thus, the period of fire resistance for building A shall be as given in column (5) and (6) of line 1.

Example 2 (Building B)

Line 2 of the Table would be applicable since the building B exceeds 28m height.

It should be noted here that, regardless of the overall height of the building, the conditions/limitations of line 2 must be complied with for the whole building and not those parts that exceed 28m height, i.e. max floor area of 2000m<sup>2</sup> per floor or compartment for all the floors, unless otherwise waived by the Relevant Authority.

Institutional building not exceeding 28m in height,  
floor area not exceeding 2000m<sup>2</sup> and no limit in cubical extent

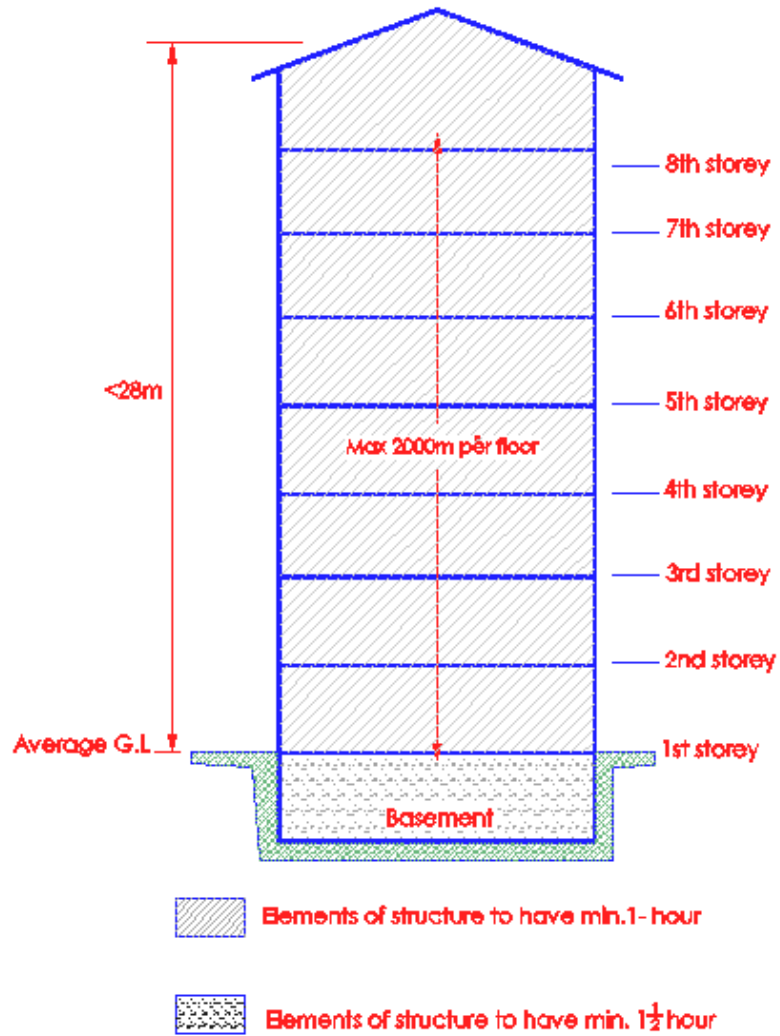
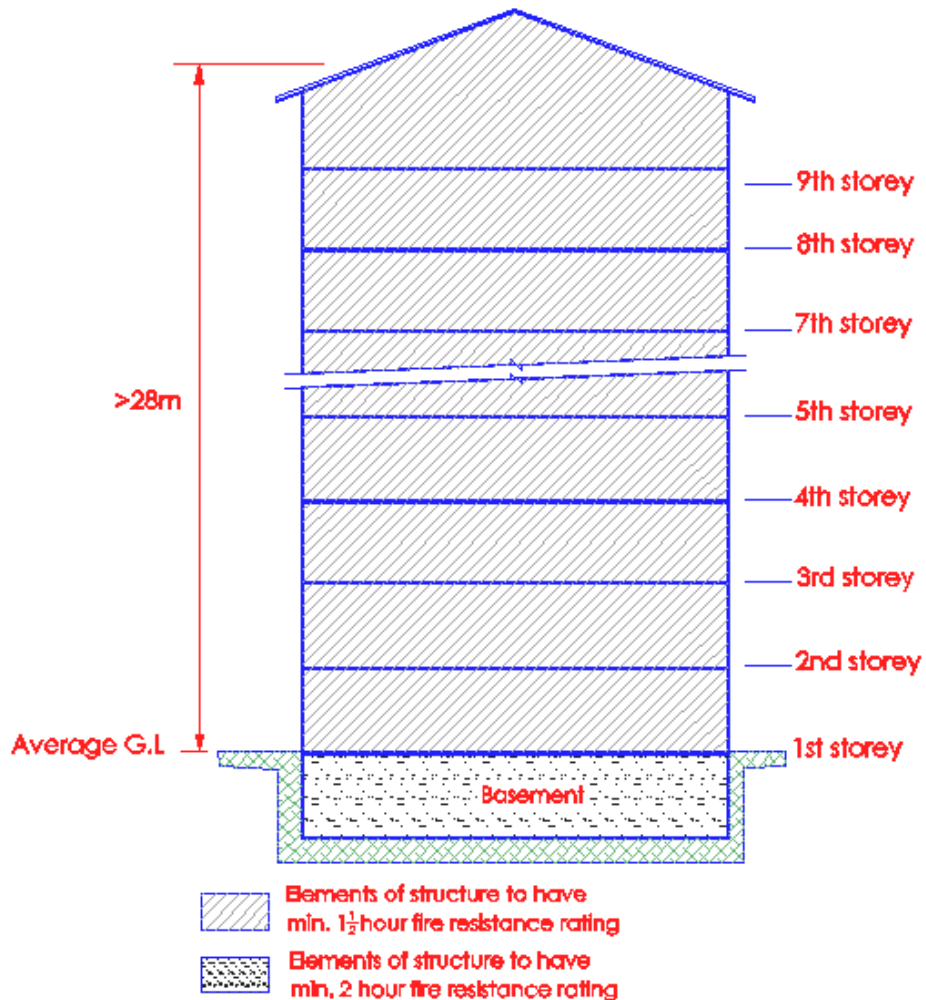

Diagram 3.3A – 1

*If the floor area of each compartment does not exceed 2000m<sup>2</sup>, then the fire resistance rating stipulated in column (5) and (6) of line 1 of the Table 3.3A Part 1, need only be applied. The elements of structure above ground shall have a minimum 1-hour fire resistance rating. For basement, the elements of structure shall have minimum 1½ hour fire resistance rating.*

Institutional building exceeding 28m in height  
and floor area not exceeding 2000m<sup>2</sup> and no limit in cubical extent



If the floor area of each compartment does not exceed 2000m<sup>2</sup>, but the height of building exceeds 28m, then the fire resistance rating stipulated in column (5) and (6) of line 2 of the Table 3.3A Part 1, shall be applied. The elements of structure above ground shall have a minimum 1½ -hour fire resistance rating. For basement, the elements of structure shall have minimum 2-hour fire resistance rating.

## Car parking buildings

Notes to Part I and Part II

(c) This period is reduced to 2 hours for open sided buildings which are used solely for car parking

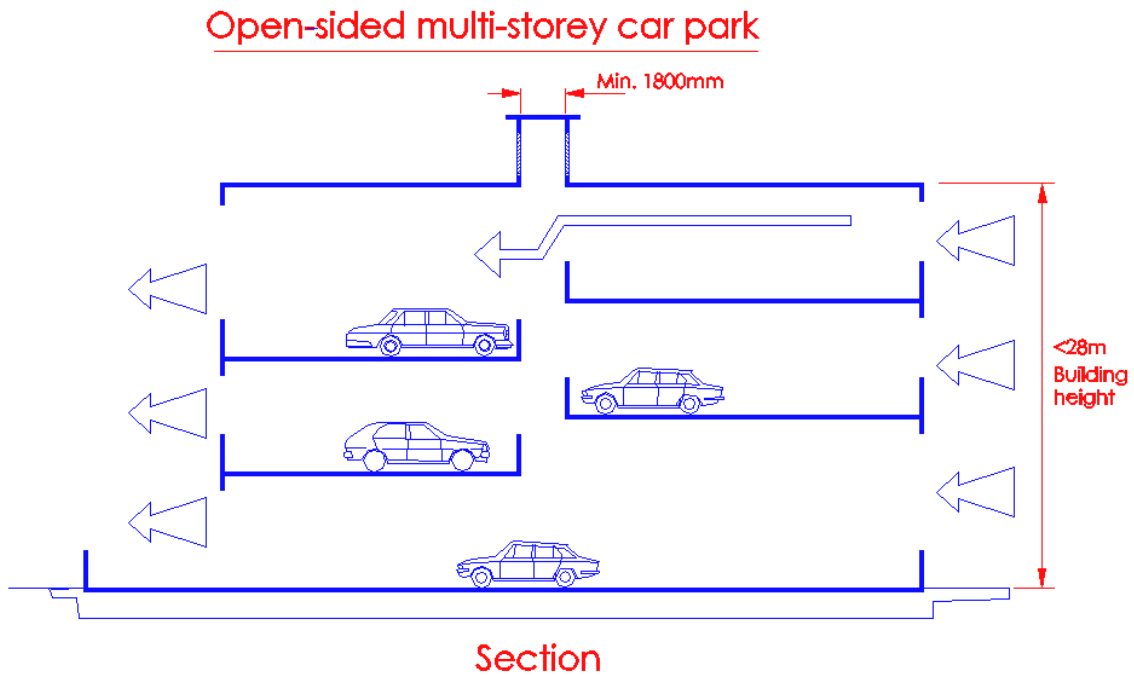

Diagram 3.3A - 3

For detached open sided above ground car parking building having a height not exceeding 28m (see Purpose Group VIII), the fire resistance rating for the elements of structure can be reduced to min. 2-hours, provided the cubical extent does not exceed 21000m<sup>3</sup>. If the building height exceeds 28m, the total gross floor area of the compartment above 28m height shall not exceed 1000m<sup>2</sup>. (See also Purpose Group VIII) The reasons for allowing the above relaxation are as follows:

- a) An outbreak of fire within a single parked vehicle is unlikely to result in uncontrolled fire spread within a car park building which is open sided.
- b) Car park buildings though classified as storage, should be treated differently from warehouse buildings, which have various types of storage materials and very much higher fire load.

## Examples of Mixed Developments

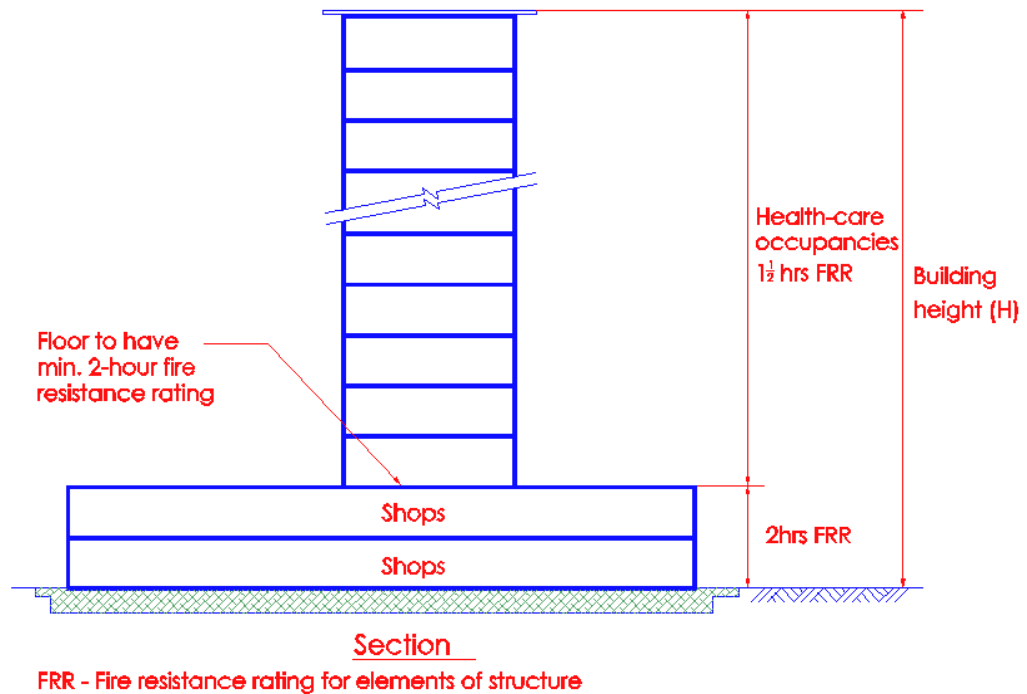

Diagram 3.3A – 4

For the purpose of working out the fire resistance rating for the elements of structure for health-care occupancy and shops, the building height 'H' of the whole development shall be taken. The fire resistance rating for the elements of structure for each type of compartment shall take into consideration the purpose group, its floor area and cubical extent. In the above diagram, the fire resistance rating of health-care occupancy compartment can be lower than the shop compartment.

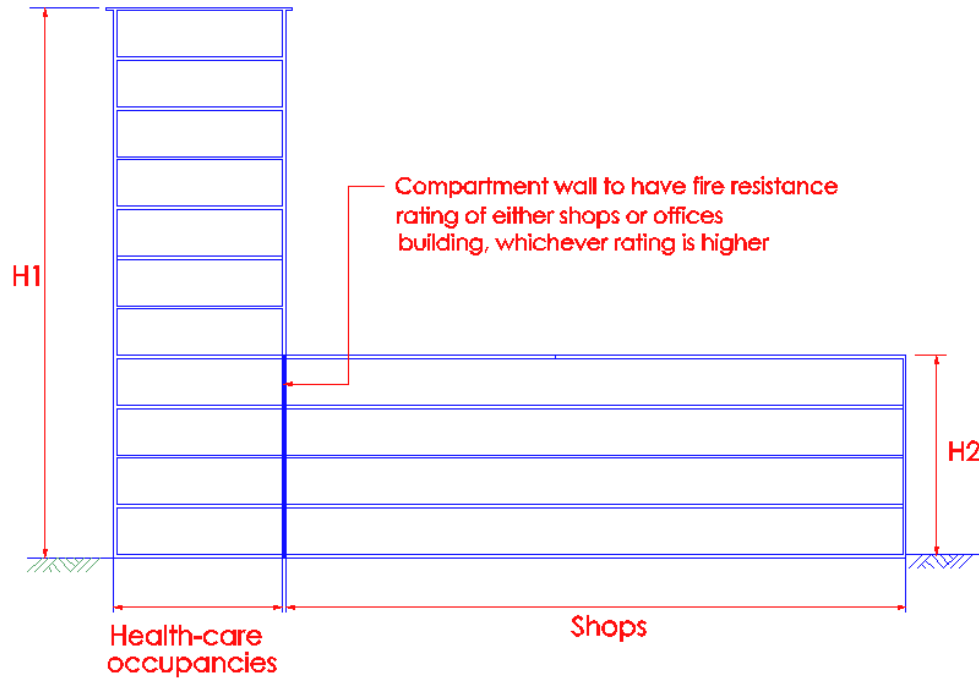

Diagram 3.3A - 5

In the above diagram as the health-care occupancies and shops are subdivided vertically by a continuous compartment wall, the reference to height for health-care occupancies shall be H1 and for shops shall be H2. The fire resistance rating for elements of structure for health-care occupancies and shops can be treated separately.

Table 3.3A – continued

(Minimum periods of fire resistance)

PART 2 – SINGLE STOREY BUILDINGS

Purpose group (1)	Maximum floor area (in m <sup>2</sup> ) (2)	Minimum period of fire resistance (in hours) for elements of structure (3)
III	3,000	½
(Institutional)		

Notes to Part 2

For the purpose of Cl.3.3.1 the period of fire resistance to be taken as being relevant to an element of structure is the period included in column (3) in the line of entries which specifies the floor area with which there is conformity or, if there are two or more such lines, in the topmost of those lines.

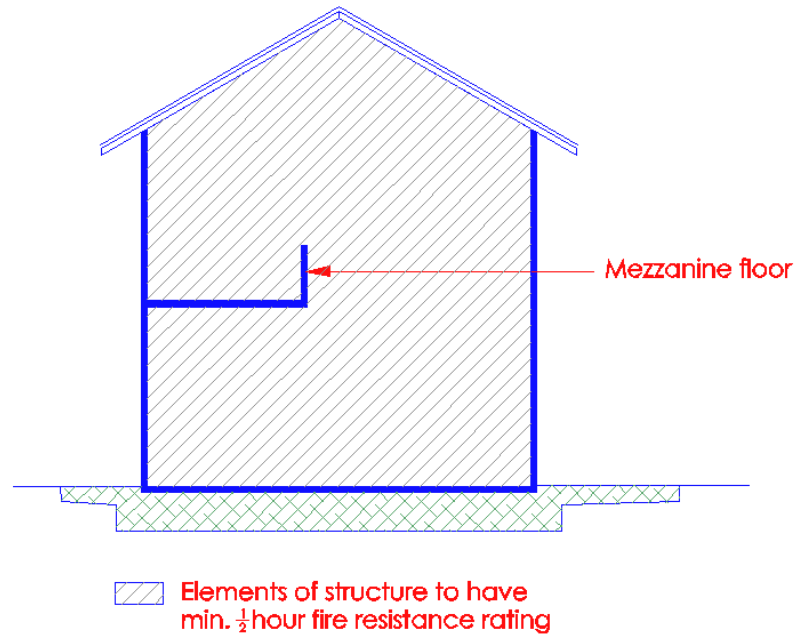

Diagram 3.3A - 6

The floor area of each compartment shall not exceed 3000m<sup>2</sup>. The columns and beams supporting the mezzanine floor shall have min. 1/2-hour fire resistance rating.



Single storey office or place of public resort building not exceeding 3000m<sup>2</sup> floor area

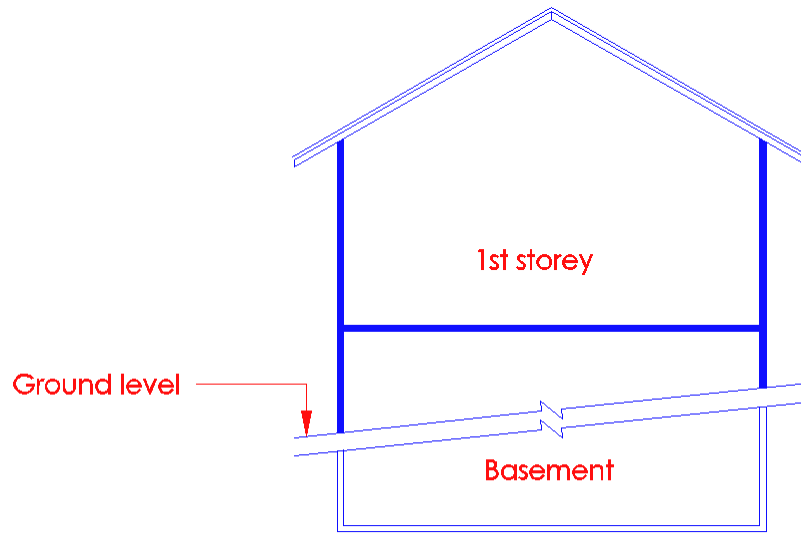

Diagram 3.3A - 7

*If the building has a basement, it is not a single-storey building for the purpose of working out the fire resistance rating for the elements of structure.*

Single storey institutional building not exceeding 3000m<sup>2</sup> floor area

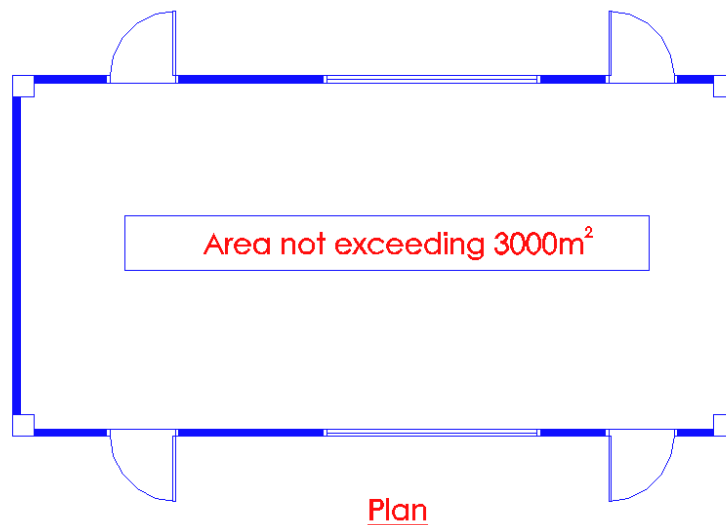
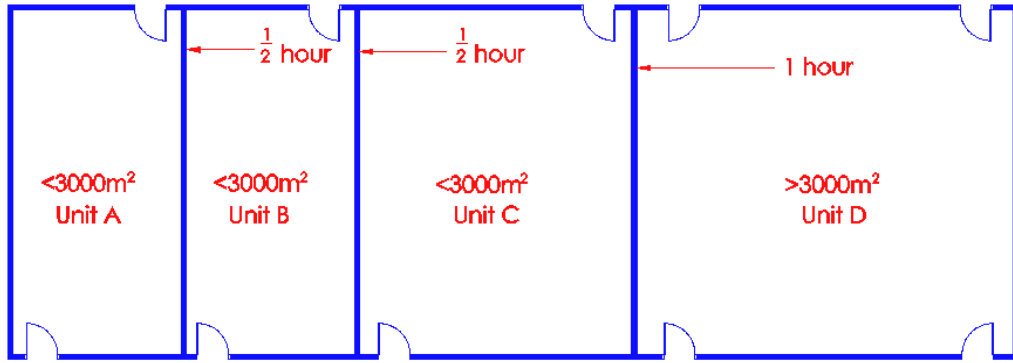

Diagram 3.3A - 8

*If floor area of each compartment does not exceed 3000m<sup>2</sup>, then the fire resistance rating ½ hour stipulated in line 1 of column (3) of Table 3.3A, Part 2, need only be applied.*



Plan

Diagram 3.3A – 9

When each of the unit is a separate compartment from one another then, the fire resistance for elements of structure for each unit shall be based on its floor area. For fire resistance rating of compartment wall between units, the rating of the larger compartment shall be used to apply to the compartment wall as shown above.

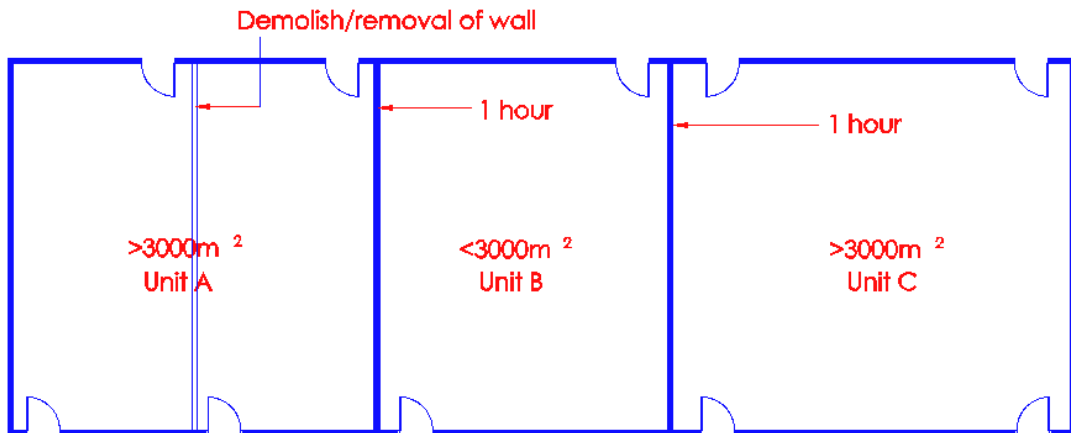

Plan

Diagram 3.3A - 10

In the case of removal of one wall (shown in dotted lines), the floor area is thus increased and exceeds  $3000\text{m}^2$ . The fire resistance rating of the wall between unit A and B as shown in the above diagram shall be upgraded to 1-hour fire resistance rating.

### 3.3.2 Exemption for non-loadbearing external walls

(a) Nothing in Cl.3.3.1 shall apply to :

any part of any external wall which is non-loadbearing and may, in accordance with Cl. 3.5 be an unprotected area.

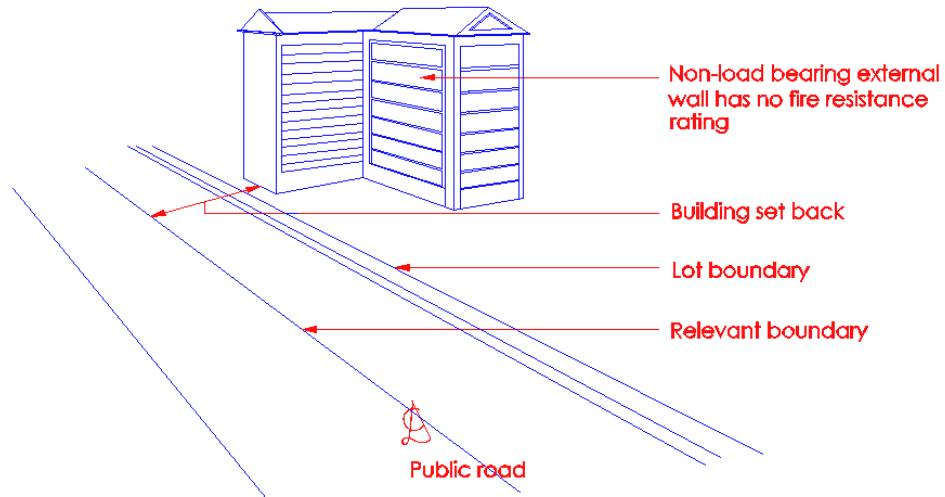

Diagram 3.3.2

*Any part of a non-load bearing external wall which constitute the unprotected opening in pursuance to clause 3.5, is not required to have any fire resistance. In the above diagram, the non-load bearing external wall facing the public road need not have fire resistance if it meets Cl.3.5 on set-back requirement, measured from the centre of the public road to the external wall.*

### 3.3.3 Exemption for single storey buildings

In the case of a single storey building or a building consisting of a first storey and one or more basement storeys, nothing in Cl.3.3.1 shall apply to any element of structure which forms part of the first storey and consists of –

- (a) A structural frame or a beam or column, provided that any beam or column (whether or not it forms part of a structural frame) which is within or forms part of a wall, and any column which gives support to a wall or gallery, shall have fire resistance of not less than the minimum period, if any, required by this code for that wall or gallery, or

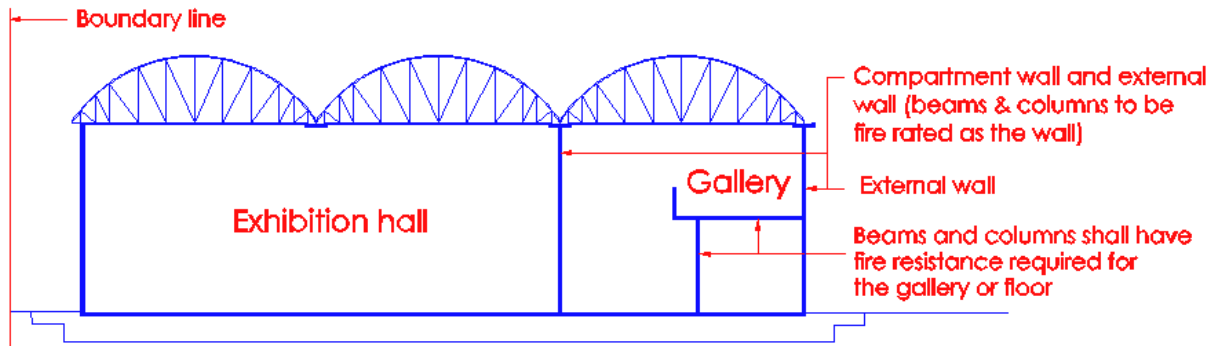

Diagram 3.3.3(a)

The above exemption applies to all single storey buildings. However, in cases where the floor area of the building exceeds 3800m<sup>2</sup>, prior consultation with SCDF (FSSD) is required.

- (i) The structural frame or beams and columns of a single storey building need not have fire resistance under Table 3.3A, unless otherwise specified by the Relevant Authority.
- (ii) However, any beam or column which is within or forms part of a compartment wall, separating wall or external wall (which requires fire resistance under clause 3.5) shall be required to have the same fire resistance rating as the wall in which such beam or column forms part of.
- (iii) Any column or beam which gives support to a wall or gallery, shall have the same fire resistance as that required for the wall or gallery, e.g. column and beam supporting the external wall or mezzanine floor shall have the necessary fire resistance rating.
- (b) An internal loadbearing wall or a loadbearing part of a wall, unless that wall or part is, or forms, part of a compartment wall or a separating wall, or forms part of the structure enclosing a protected shaft or supports a gallery, or

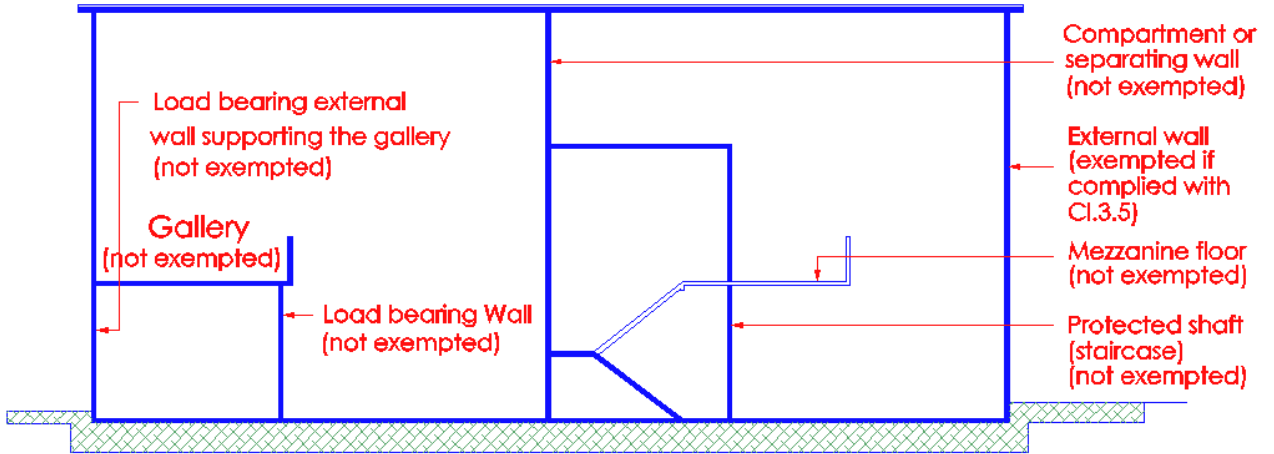

Diagram 3.3.3(b)

An internal loadbearing wall or a loadbearing part of a wall is not required to have fire resistance under Table 3.3A, provided the wall is not –

- i) forming part of or a compartment or separating wall
  - ii) forming part of the structure enclosing a protected shaft e.g. exit staircase; or
  - iii) supporting a gallery.
- (c) Part of an external wall which does not support a gallery and which may, in accordance with Cl.3.5 be an unprotected area.

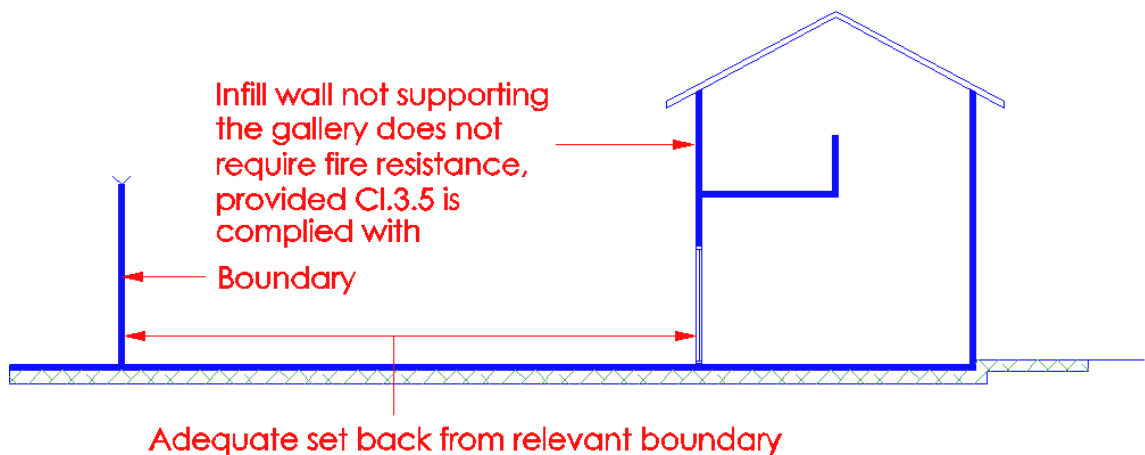

Diagram 3.3.3(c)

External wall, which does not support a gallery and meets the requirements of Cl.3.5 to be unprotected area, need not have fire resistance under Table 3.3A.

### 3.3.4 Interpretation and application of this regulation

The interpretation and application of Cl.3.3 shall be as follows:

- (a) Subject to the provisions of sub-cl.(b) and any other expressed provision to the contrary, any reference to a building of which an element of structure forms a part means the building or (if the building is divided into compartments) any compartment of the building of which the element of structure forms a part, and

#### Building not divided into compartments

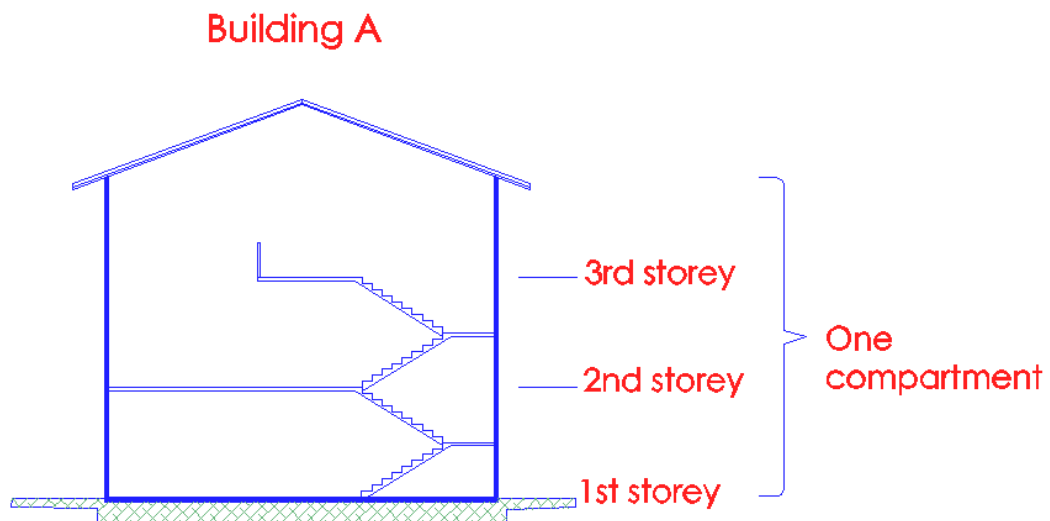

Diagram 3.3.4(a) - 1

*Any reference to a building of which an element of structure forms a part means the building.*

## Building divided into compartments

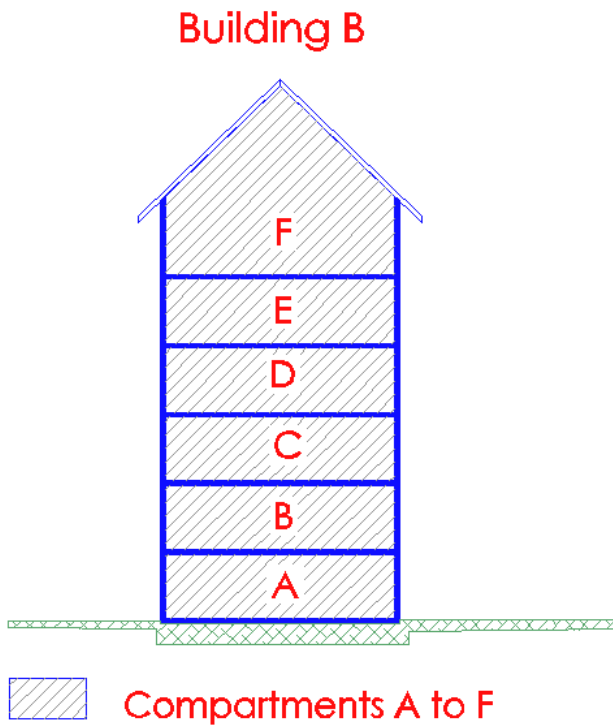

Diagram 3.3.4(a) - 2

*Any reference to a building, of which an element of structure forms a part, means any compartment of the building of which the element of structure forms a part.*

*It is important to note that any element carrying another element of structure must have at least the same fire resistance as the element it is supporting.*

- (b) Any reference to height means the height of a building, but if any part of the building is completely separated throughout its height both above and below ground from all other parts by a compartment wall or compartment walls in the same continuous vertical plane, any reference to height in relation to that part means the height solely of that part, and

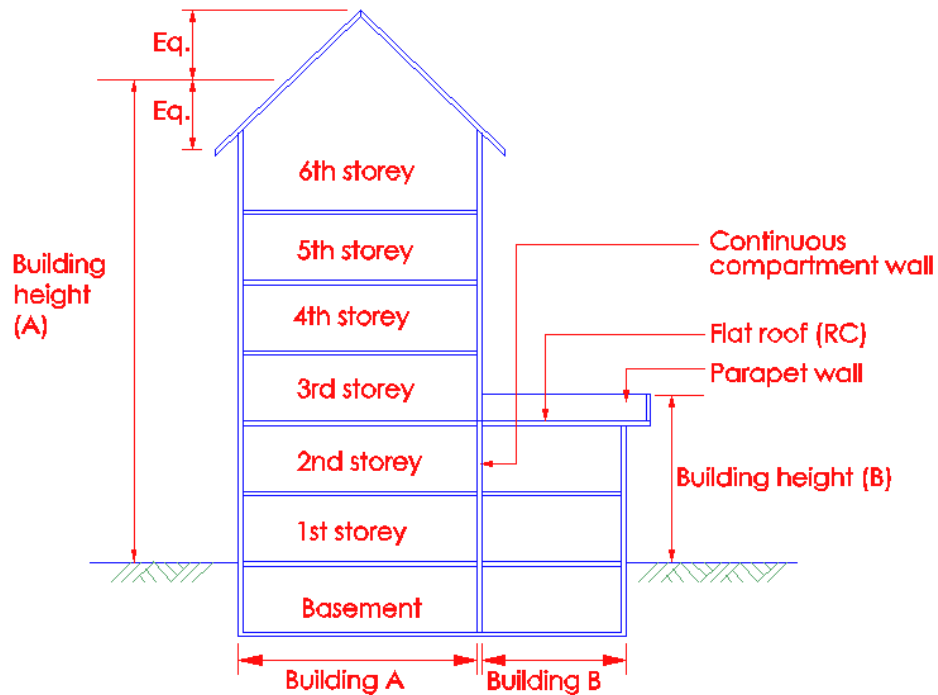

Diagram 3.3.4(b)

*The continuous vertical compartment wall divides the building into 2 parts. For building A, any reference to height means the building height (A). For building B, any reference to height means the building height (B). The above clause is intended to provide relaxation for the lower building.*

- (c) If any element of structure forms part of more than one building or compartment and the requirements of fire resistance specified in Table 3.3A in respect of one building or compartment differ from those specified in respect of any other building or compartment of which the elements forms a part, such element shall be so constructed as to comply with the greater or greatest of the requirements specified.



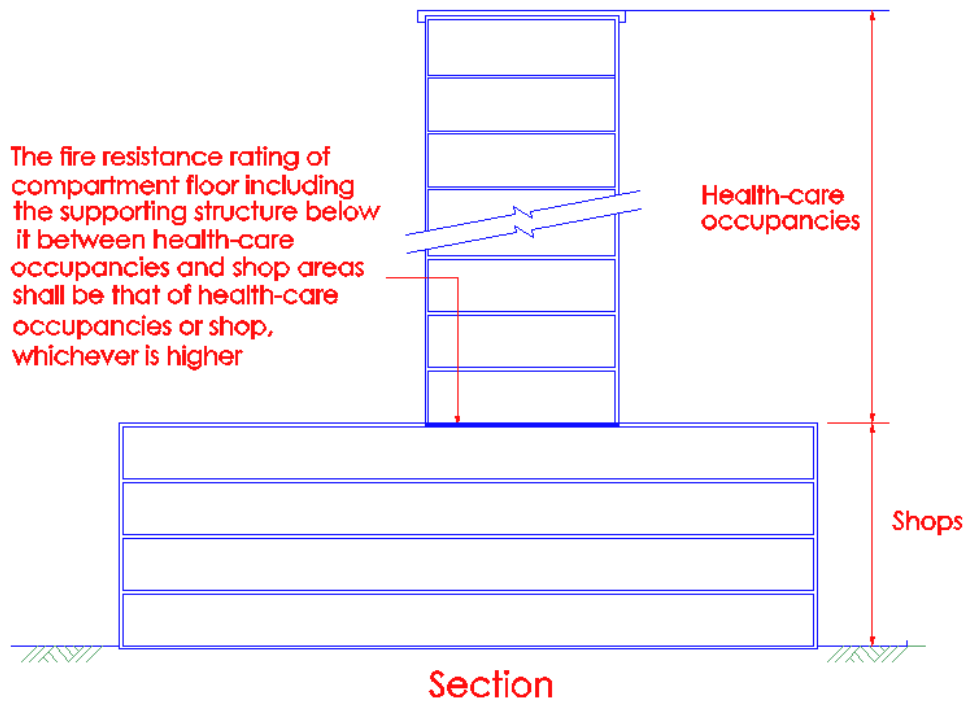

Diagram 3.3.4(c)

The diagram above shows a shopping podium and a health-care occupancy tower. The fire resistance of the elements of structure at the interface between the podium and tower shall be the higher of the two purpose groups (shops or health-care occupancies).

The elements of structure referred to include compartment floor and also the columns going through the podium to support the structural frame of the health-care occupancy tower.

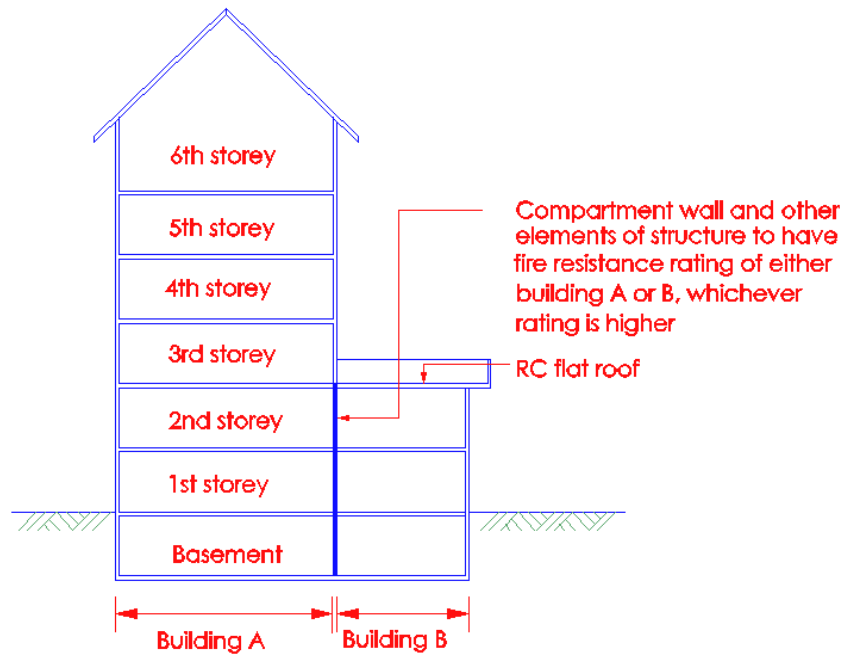

Diagram 3.3.4(c) – 2

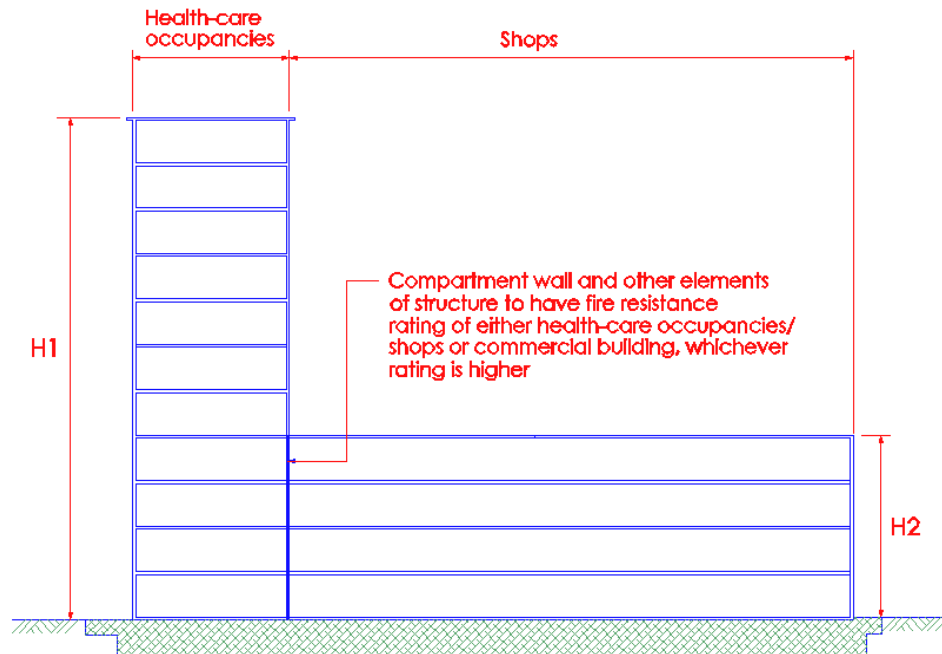

Diagram 3.3.4(c) – 3

In the above diagrams, the continuous vertical compartment wall forms part of more than one building or compartment. The compartment wall shall be constructed to have higher fire resistance rating of the two buildings or compartments.

- (d) If any element of structure is required to be of non-combustible construction (excluding materials of limited combustibility), the measure of fire resistance rating shall be determined by the part which is constructed wholly of non-combustible materials. (With the exception of fire protecting suspended ceilings, surface materials for walls and ceilings and floor finishes may be combustible, if they are not relied on to contribute to the fire resistance of the wall or floor).

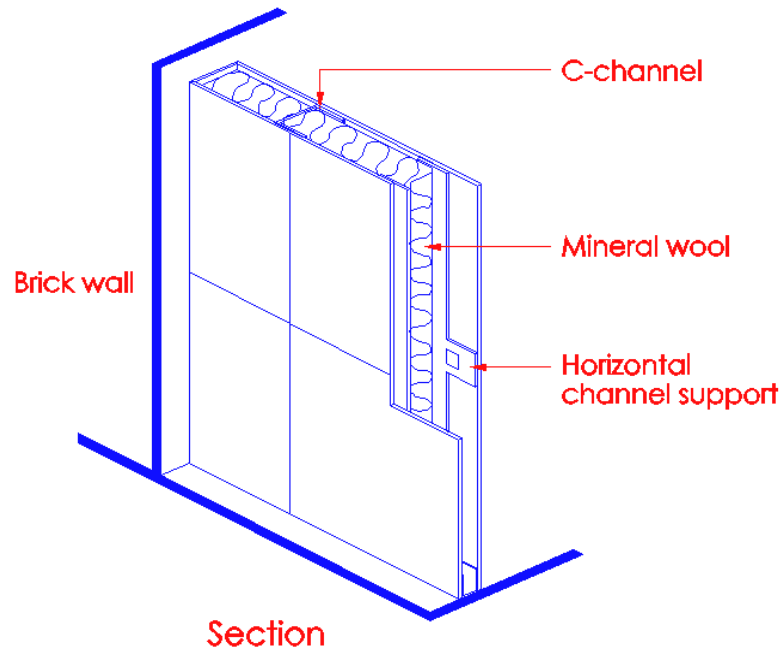

Diagram 3.3.4(c)-4

The above diagram shows the construction of a non-load bearing fire rated compartment wall. If the C-channels or horizontal channel supports are replaced with timber members, the construction would not meet the requirement of the above subclause, as timber members are combustible. However, combustible finish if added to the surface of the wall would be considered as acceptable, provided it complies with Cl.3.13.

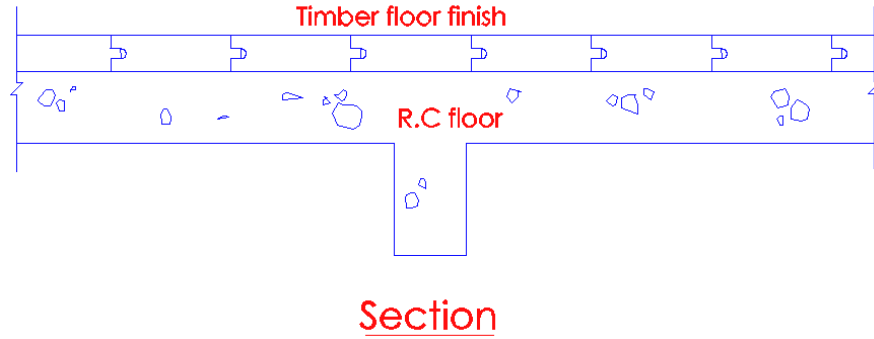

Diagram 3.3.4(d) -2

The above diagram shows the addition of timber floor finish to the R.C floor. The combustible floor finish is not to be considered as contributing to the fire resistance of the floor.

For fire protection suspended ceilings see cl. 3.3.6. The above clause is also not applicable to buildings under preservation or conservation where structural timber members are required to be retained. See also cl. 3.4.3.

### 3.3.6 Suspended ceiling

In determining the fire resistance of floors, no account shall be taken of any fire resistance attributable to any suspended ceiling unless the ceiling is constructed specifically as a fire protecting suspended ceiling and the construction complies with the requirements under Table 3.3B for Limitations on Fire Protecting Suspended Ceilings.

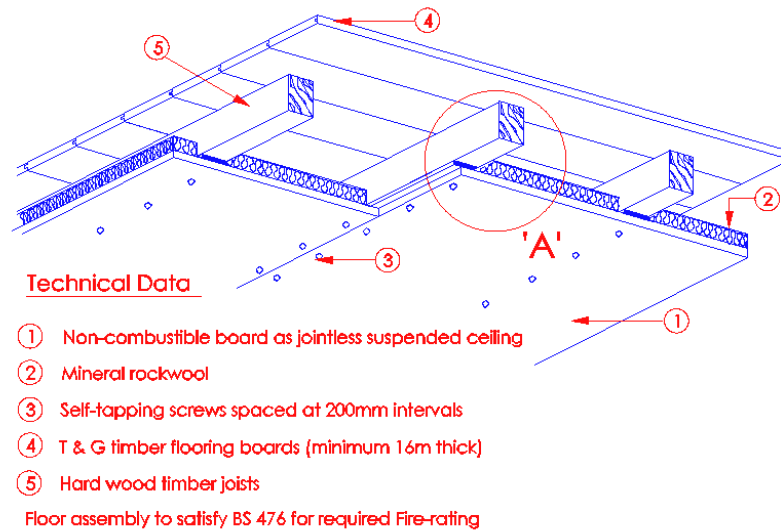
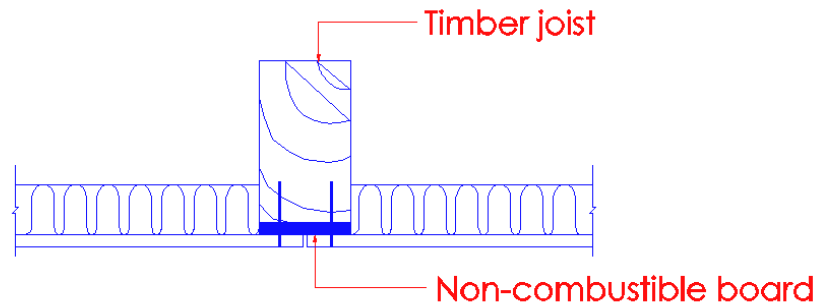

Diagram 3.3.6 - 1



### Detail A

The above is generally provided to prevent fire spread through the butt joint of the suspended ceiling

The implications of clause 3.3.6 are that the normal type of suspended ceiling consisting of separate tiles cannot be counted as contributing to the fire resistance of the floor in buildings over 15m high where the period required is one hour; or in buildings of any height where the period required is more than one hour. In these circumstances only jointless ceilings can be considered as contributing

The above diagram shows a protective ceiling being added to the underside of a timber floor, shall apply only to buildings under conservation where retention of the timber floor is required, and in buildings under Purpose Groups I & II for the construction of attic. In addition to the four grades of ceiling given in Table 3.3B, other ceiling construction to tested prototype listed in PSB product listing scheme would be considered as acceptable.

The ceiling shown in diagram 3.3.6 - 1, shall be constructed specifically as a fire protecting membrane and comply with Table 3.3B on limitation of fire protecting suspended ceiling. As the ceiling is intended as a protecting membrane, the concealed ceiling space shall not be used for recessed lighting and other service, such as air-con ducts, cables, pipes etc, even if these services are housed in fire rated enclosures.

Suspended Ceilings which are contributing to the Fire resistance rating of the floor under Table 3.3B

Height of building less than 15m

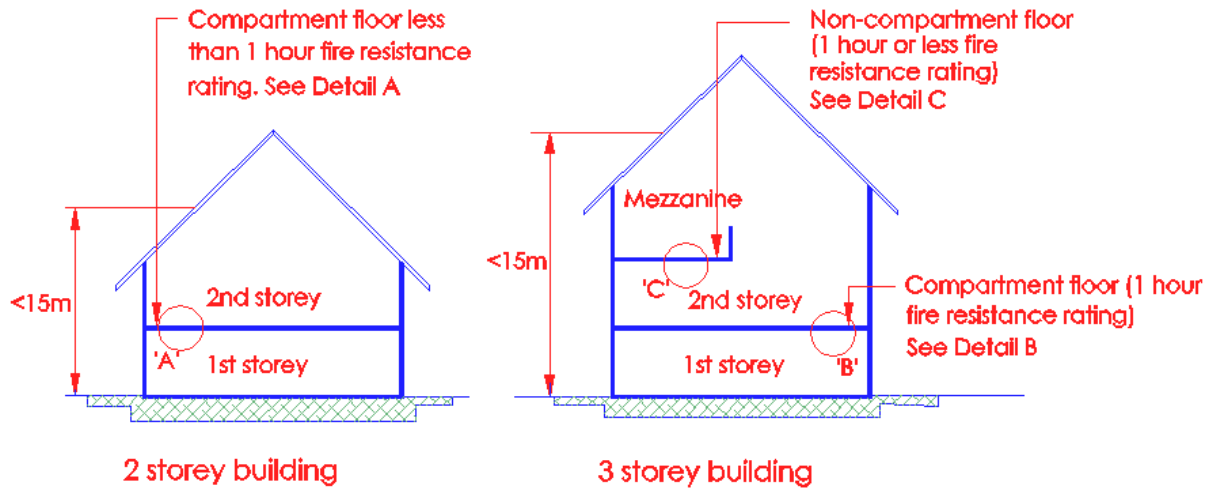
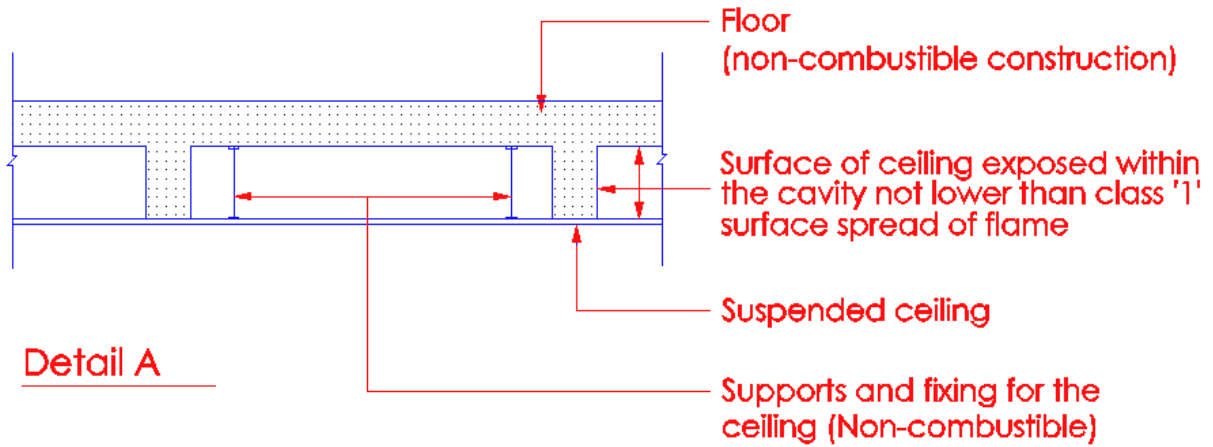
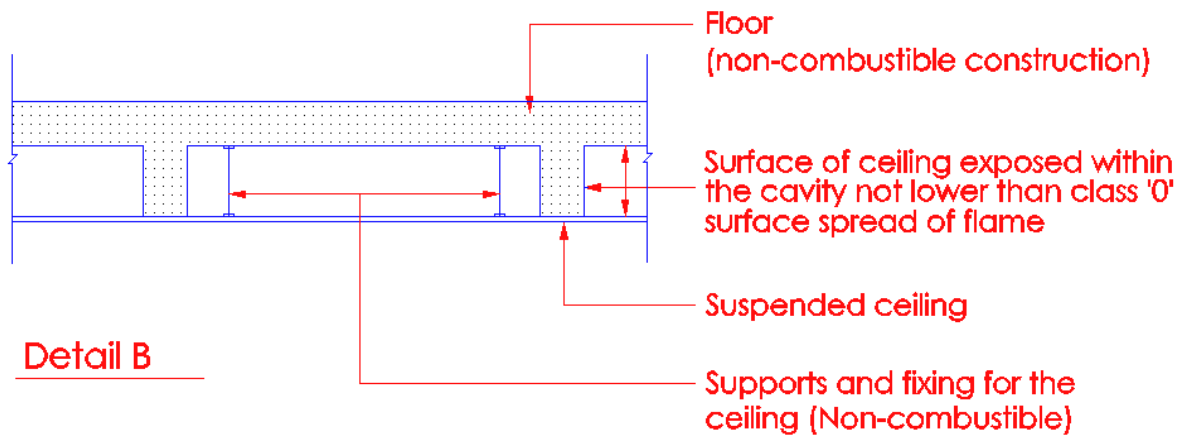

Diagram 3.3.6 – 2

Compartment floor requiring less than 1 hour fire resistance rating



Compartment floor requiring 1 hour fire resistance rating



Non-compartment floor requiring 1 hour or less fire resistance rating

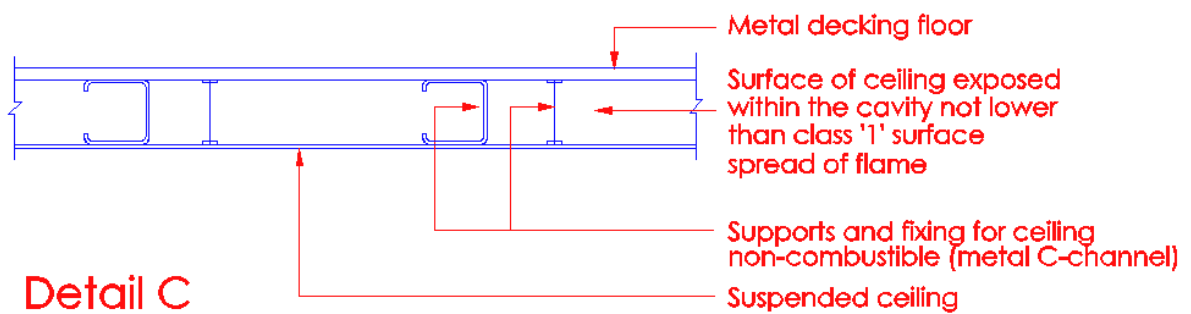

Height of building – 15m or more

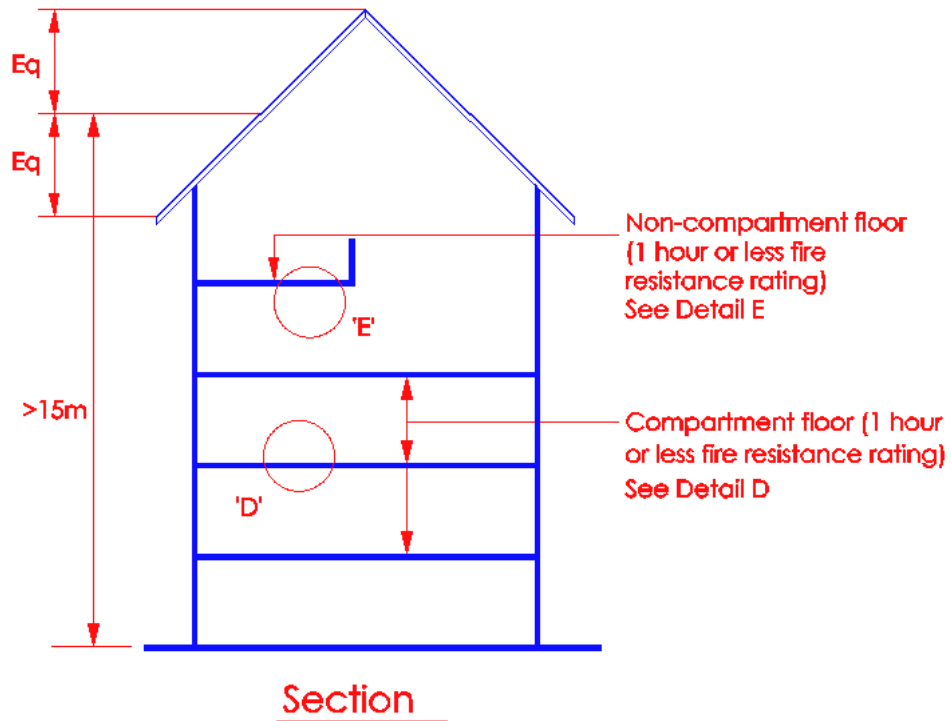
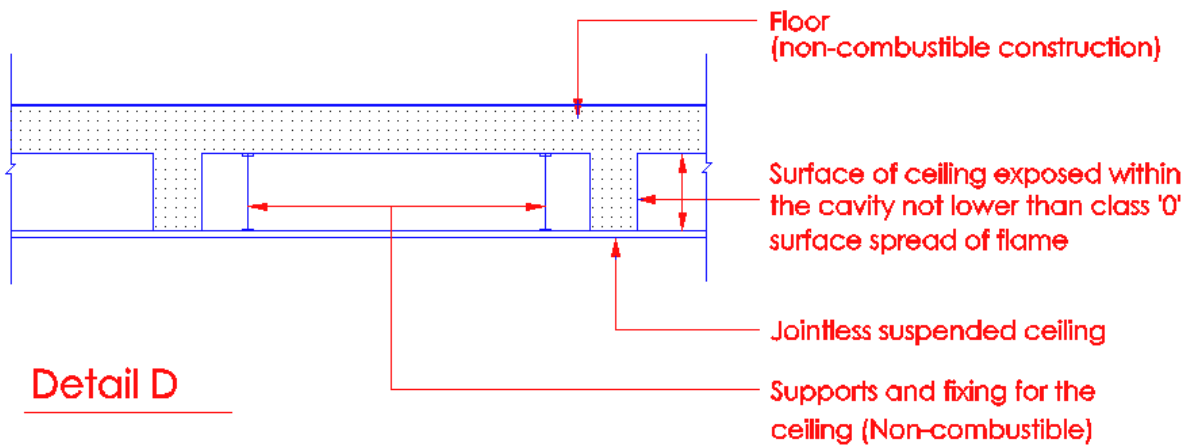

Diagram 3.3.6 - 3

Compartment floor requiring 1 hour or less fire resistance rating





Non-compartment floor requiring 1 hour or less fire resistance rating

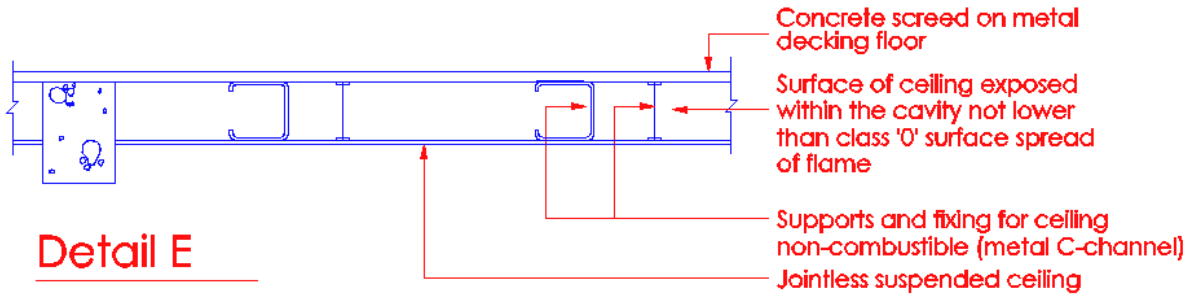

Height of building – any height

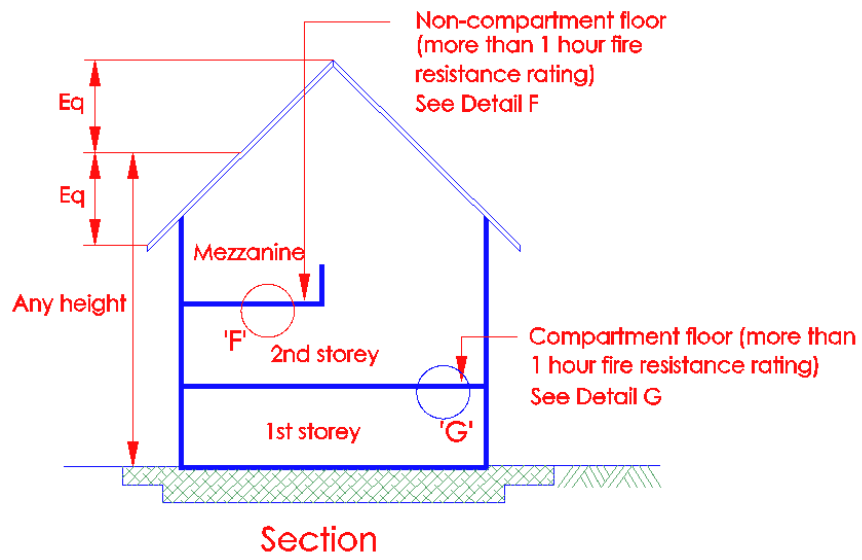
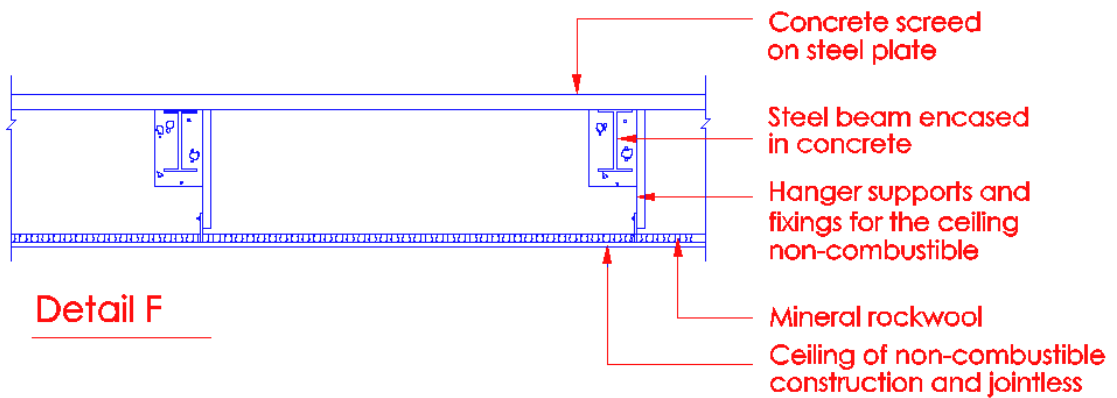
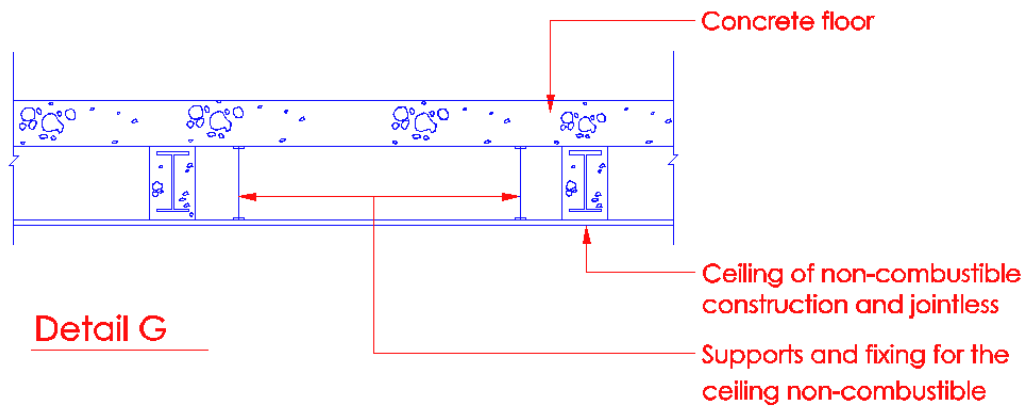

Diagram 3.3B - 4

Non-compartment floor requiring more than 1 hour or less fire resistance rating



## Compartment floor requiring more than 1 hour fire resistance rating



The foregoing diagrams illustrate the intent of the clause, which basically deals with the contribution by suspended ceilings to the fire resistance of floors. The provision of suspended ceilings for the protection of the floors shall be treated separately from that provided for the protection of structural steel works in the ceiling space.

Where the space above a suspended ceiling is protected by an automatic sprinkler system it shall be exempted from the requirements for non-combustibility and surface spread of flame classification as specified in the above Table, provided the ceiling is not situated over an exit passageway, protected lobby or other required protected means of escape, and that the ceiling space is not used as an air-plenum.

### 3.3.7 Fire rated board

Fire rated boards are permitted to be used for protection to structural steel beams and columns in building not exceeding the habitable height of 24m; and to beams only, except load-bearing transfer beams, in building exceeding the habitable height of 24m; if the following conditions are satisfactorily fulfilled:



Diagram 3.3.7

- (i) Material shall be non-combustible (BS476 Pt 4 or Pt 11); and
- (ii) It shall have fire resistance for not less than the relevant period specified in Table 3.3A having regard to the purpose group of the building of which it forms a part and the dimensions specified in that Table; and
- (iii) It shall meet the criteria, in terms of water absorption and bending strength performance, when subject to test of BS1230 Pt 1 (for gypsum plaster board) or ISO 1896 (for calcium silicate or cement board); and
- (iv) The fire rated boards shall be constructed to be in contact with the steel column. If it is unavoidable, the void space between the fire rated board and the steel column shall be adequately filled to a height of 1.2m, measured from finished floor level, with fire protective material such as concrete, gypsum or grout to prevent any possible denting of the boards; and
- (vi) There shall be no services running in the space between the steel structure and fire rated boards, unless these services are encased in concrete or run in steel conduits.

Note :Fire rated boards should not be used to protect structural steel in areas which may be subject to explosion risks as the boards may be displaced by the force of the blast.

(No illustration)

*Running of services in the space between the steel structure and fire rated boards should be discouraged, unless it is unavoidable.*

*Services shall be limited to cables only and shall not include duct, gas pipes, fuel oil pipes, etc.*

### **3.4 TEST OF FIRE RESISTANCE**

#### **3.4.1 Fire resistance**

Performance for the fire resistance of elements of structure, doors and other forms of construction shall be determined by reference to the methods specified in BS 476:Part 20 to 23, which specify tests for stability, integrity and insulation.

Specific requirements for each element in terms of the three performance criteria of stability, integrity and insulation are given in Table 3.4A,

(No illustration)

In conjunction with Part 20, methods of test are provided for – Beams, columns, floors, flat roofs and walls(Part 21); Partitions, doorsets and vertical shutter assemblies, ceiling membranes and glazed elements(Part 22); and Suspended ceilings protecting steel beams and intumescent seals for use in conjunction with single acting latched timber fire-resisting door assemblies(Part 23). Part 20 specifies standard heating conditions based on a temperature/time curve (Diagram 3.4.1) which furnaces are required to follow; the temperature at defined locations close to the exposed face of the specimen under test rising to 821°C after 30 minutes and 1133°C after four hours.

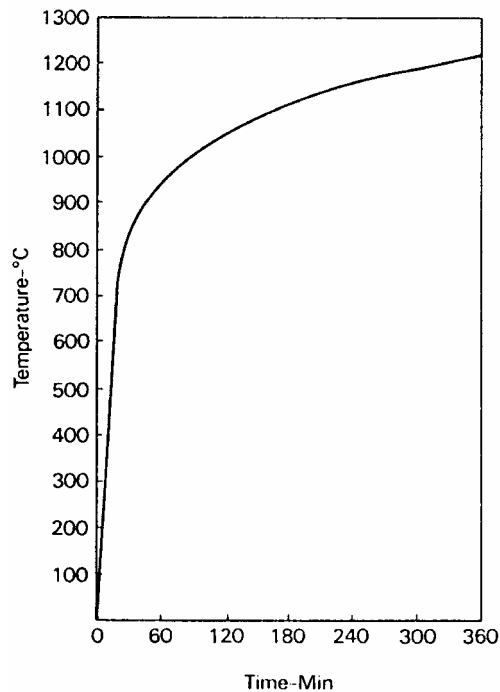

Diagram 3.4.1

Standard temperature/time curve (BS 476: Part 20 )

The specimen to be tested should be either full size or, where the element exceeds the size that can be accommodated by the furnace, it must have the following minimum dimensions.

Non-separating elements: Vertical 3m high  
Horizontal 4m span

Separating elements: Vertical 3m high X 3m wide  
Horizontal 4m high X 3m wide

Specimens are normally heated to simulate their exposure in a fire, eg walls from one side, floors from beneath and columns from all sides.

Elements of building construction are required to satisfy various criteria according to their designed function in the event of fire. These are:

- |                                       |   |
|---------------------------------------|---|
| “Stability” or “Loadbearing capacity” | - the ability of a loadbearing element to support its test load without excessive deflection;   |
| “Integrity”                           | the ability of a separating element to resist collapse, the formation of holes, gaps or fissures through which flames and/or hot gases could pass, and the occurrence of sustained flaming on the unexposed face (the side of the specimen remote from the furnace) |
| “Insulation”                          | - the ability of a separating element to resist an excessive rise in temperature on its unexposed face.   |

The criterion of “stability” or “loadbearing capacity” is applied only to loadbearing elements. For floors, flat roofs and beams, allowable vertical deflection is limited to 1/20 clear span.

Loss of “integrity” in the context of the formation of holes, gaps or fissures is judged by ignition of a cotton fibre pad. Where this test is not suitable, failure is deemed to have occurred if either a 25mm diameter gauge can penetrate into the furnace through a gap at any point, or a 6mm diameter gauge can penetrate into the furnace through an opening and can be moved for a distance of at least 150mm.

Loss of “insulation” occurs when the temperature on the unexposed face (the side of the specimen remote from the furnace) increases by more than 140°C (mean) or by more than 180°C at any point. Loss of “integrity” also constitutes loss of “insulation”.

Columns and beams have to satisfy only the criterion of “loadbearing capacity”; glazed elements are normally required to satisfy only “integrity”; and floors and walls have to satisfy all three criteria. It is pertinent to note that under Table 3.4A, doors are only required to satisfy “integrity”, leaving aside “insulation” as it is assumed unlikely that combustible materials would be stored against them. However, doors to protected lobbies, exit staircases and exit passageways should be provided with insulation against transmission of heat by radiation from the fire floor into the protected enclosures which occupants use for evacuation.

It is important to note that fire rated glass door shall not be used in protected lobbies, exit staircases and exit passageways.

### 3.4.2 “Deem to satisfy” provisions

An element of structure, door or other part of a building shall be deemed to have the requisite fire resistance if –

- (a) It is constructed to the same specification as that of a specimen exposed to test by fire in accordance with the method and procedure under BS 476: Part 20 to 23, and satisfied the requirements of that test for the three performance criteria of stability, integrity and insulation for not less than the specified period, or
- (b) In the case of a wall, beam, column, stanchion or floor to which Appendix A to Cl.3.4 relates, it is constructed in accordance with one of the specification set out in that Appendix and the notional period of fire resistance given in that Appendix as being appropriate to that type of construction and other relevant factors is not less than the specified period.

*(No illustration)*

*Sub-clause 3.4.2(b) provides the alternative to complying with the specification of tested prototype under BS476 Part 20 to 23. Specification set out in Appendix A to Cl.3.4 could be used and there is no need to obtain separate testing. However, on completion of the building works, the qualified person concerned is to forward to SCDF (FSSD) his/her certificate of supervision that the relevant specification listed in Appendix A to Cl. 3.4 had been complied with on site when applying for TFP or FSC.*

### 3.4.3 Timber floors

The use of timber floors shall not be allowed, except:

- (b) in buildings designated for conservation where the timber floors are required to be retained, but subject to compliance with the technical guidelines for 'FIRE SAFETY REQUIREMENTS AFFECTING SHOPHOUSES UNDER CONSERVATION.'

*(No illustration)*

*SCDF (FSSD) issued a circular on 13 Jan 99, to allow the “Fire Safety Requirements Affecting Shophouses Under Conservation” be made applicable to old shophouses not designated for conservation. Please refer to the circular for more details.*

### 3.5 EXTERNAL WALL

3.5.1 Requirements of External Walls shall be as follows:

- (a) Any external walls of a building or a separated part of a building which constitutes or is situated within a distance of 1m from any point on the relevant boundary, or is a wall of a building or a separated part of a building which exceeds 15m in height shall-
  - (i) be constructed wholly of non-combustible materials apart from any external cladding which complies with Cl.3.5.2 or any internal lining which complies with Cl.3.13.4, and
  - (ii) be so constructed as to attain the fire resistance required by this chapter, and

Buildings of any height situated at 1m or less from relevant boundary

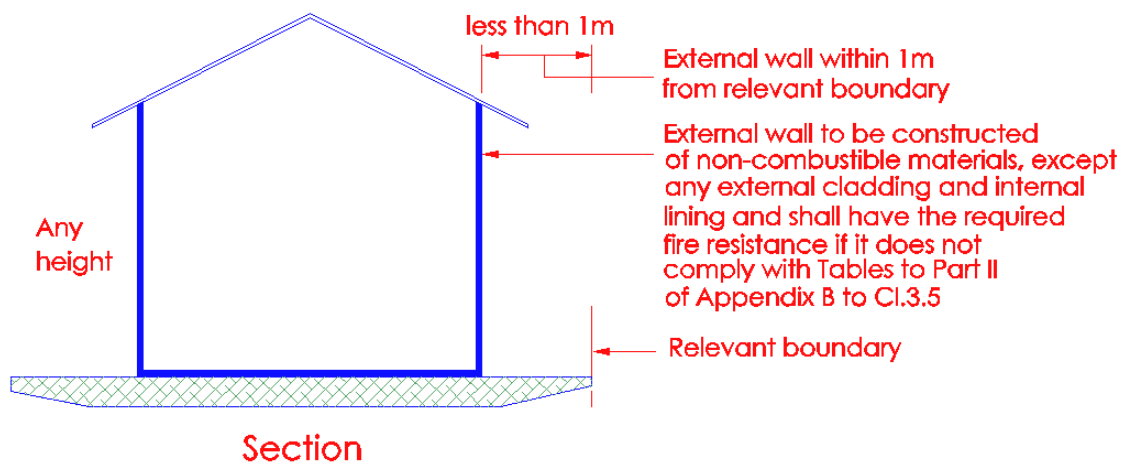

Diagram 3.5.1 – (1)

## Buildings of any height situated at 1m or less from relevant boundary

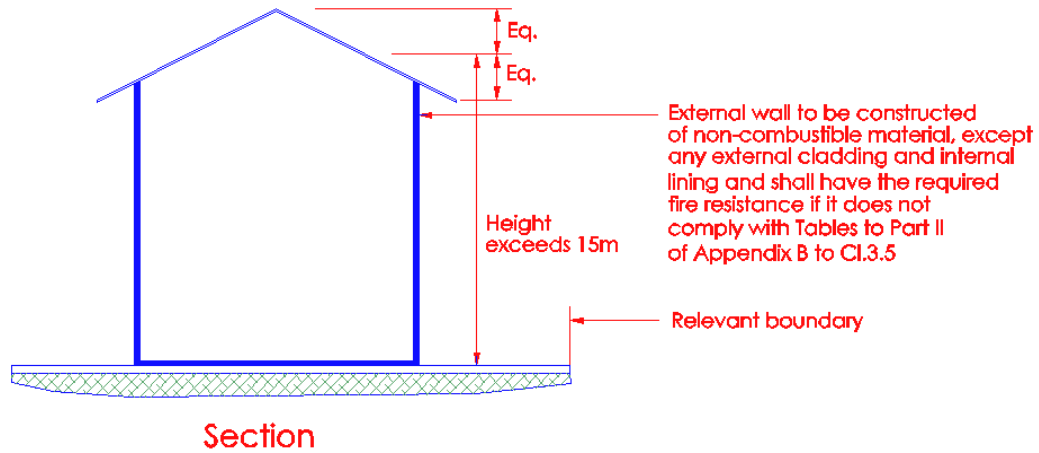

Diagram 3.5.1 – (2)

- \* Where the external wall of a building which exceeds 15m in building height or is within 1m of the relevant boundary, the entire external wall shall be constructed wholly of non-combustible materials, apart from any external combustible cladding under Cl.3.5.4 or internal combustible lining under Cl.3.13.4.
- \* The external wall of building which is sited less than 1m from the relevant boundary, shall be imperforate, free of any unprotected area and have the necessary fire resistance rating, both inside and outside. The required fire resistance shall be achieved by the non-combustible part alone.
- \* The external wall shall have the necessary fire resistance rating as required of the elements of structure of the building or compartment, in which the wall is located, in accordance with Table 3.3A, Part 1.
- \* Any part of the external wall which is to be treated as unprotected area in accordance with Tables to Part II of Appendix 'B' to Cl.3.5, need not have fire resistance.
- \* If the entire external wall is to be treated as unprotected area, the separation distance between the external wall and the relevant boundary shall comply with Tables to Part II of Appendix 'B' to Cl.3.5.
- \* External walls, which are more than 1m from the boundary, need to resist the effect of fire from the inside only.

Note : "Cl.3.5.2" appearing in sub-clause 3.5.1(a)(i) should read as "Cl.3.5.4".

In cases where the external walls of buildings are situated less than 1m from relevant boundary, the external walls shall be treated as separating walls. The requirements under Cl.3.6 shall be fully complied with.



- (b) Any beam or column forming part of an external wall and any structure carrying an external wall which is required to be constructed of non-combustible material, shall comply with the provisions of sub-cl. (a)

(No illustration)

Any beam or column forming part of an external wall and any structure carrying an external wall shall be constructed of non-combustible materials and have the necessary fire resistance rating of elements of structure, apart from any external cladding which complies with Cl.3.5.4 or any internal lining which complies with Cl.3.13.4. The required fire resistance shall be achieved by the non-combustible part alone.

### 3.5.2 Exceptions

The requirements of Cl.3.5.1(a)(i) for non-combustibility of external walls shall not apply to the external wall of a building or separated part of a building-

- (a) If that wall is :
- (i) situated 1m or more from the relevant boundary; and
  - (ii) not exceeding 15m in height; and
  - (iii) separated as described in Cl.3.3.4(b); or

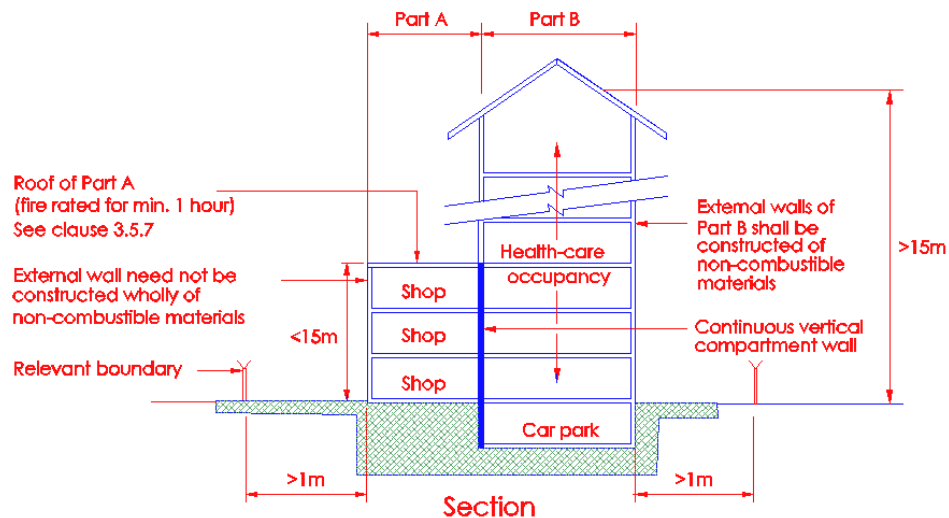

Diagram 3.5.2(a)

The above sub-clause is applicable to separated part of building as described in Cl.3.3.4(b), which is illustrated in diagram 3.5.2(a).

Part A of the building comprising shops which is separated from other parts of the same building by a continuous vertical compartment wall would qualify for exemption of non-combustibility of external construction if;

- (a) the entire external wall does not exceed 15m in height, measured from the outside ground; and
- (b) the external wall is situated 1m or more from the relevant boundary.

3.5.2 (b) if that wall is situated 1 m or more from the relevant boundary:

- (ii) of single storey construction and not exceeding 15 m in height and floor area not exceeding –

purpose group III - 3000 m<sup>2</sup>

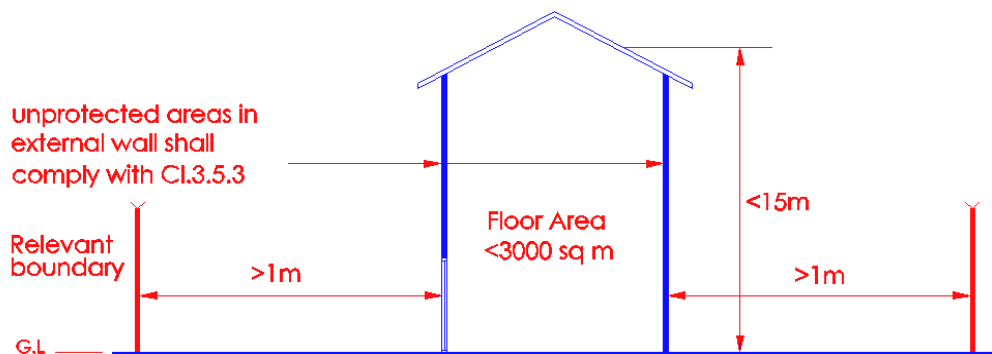

Diagram 3.5.2(b)(ii)

Single storey health care occupancy, schools, old folk's home, etc (Purpose Group III) need not comply with non-combustibility of external wall, if it complies with the requirements under sub-clause b(ii) above.

3.5.3 Unprotected areas in any side of a building

Except where otherwise provided, unprotected areas in any side of a building shall comply with the following:

- (a) Any relevant requirements relating to the permitted limits of unprotected areas specified in Appendix B unless the building is so situated that such side may be in accordance with Appendix B consists entirely of any unprotected area, and

(No illustration)

*Unprotected areas in relation to a side or external wall of a building means:*

- (i) a window, door or other opening, and*
- (ii) any part of the external wall which has less than the relevant period of fire resistance required under cl.3.5, and*
- (iii) any part of the external wall which has combustible material more than 1mm thick attached or applied to its external face whether for cladding or any other purpose.*

*The extent of unprotected areas in the external wall in relation to the setback from relevant boundary or lot boundary shall be in accordance with Appendix B to Cl.3.5. The further the building is setback from the relevant boundary, the greater the amount of unprotected areas would be permitted.*

*An example on calculations of unprotected openings/setback from relevant boundary is given in page 177. The intensity of the heat produced by a fire within a building, which can reach the relevant boundary, will depend upon the extent of the "unprotected areas" in the external walls and the distance between these walls and the relevant boundary. The heat flux at the relevant boundary shall be less than that normally required for pilot ignition of combustible material after a period of exposure.*

*Thus, there is need to control the extent of "unprotected area" which can be permitted in relation to the distance from the relevant boundary.*

*In situations where the extent of unprotected areas in external walls do not comply to Appendix B, the qualified person has 4 alternatives. These are:*

- (a) reduce the total unprotected area; or*
  - (b) increase the distance from the relevant boundary; or*
  - (c) introduce compartmentation within the building to break up the size of enclosing rectangle or*
  - (d) introduce automatic sprinkler system so that the unprotected areas can be doubled or the distance from the relevant boundary can be reduced by half.*
- (b) The extent of unprotected openings in an external wall of a building or compartment in relation to its distance from the lot boundary may be double that which is specified in Appendix B when the building or compartment is :
- (ii) fitted throughout with an automatic sprinkler system in compliance with the requirements in Chapter 6.

*(No illustration)*

For subclause b(ii), more relaxation is granted with installation of sprinkler system taking into consideration the expected fire size.

- (c) The distance between the external wall of a building and the relevant boundary may be half that specified in Appendix B if the building is fitted throughout with an automatic sprinkler system in compliance with the requirements in Chapter 6.

(No illustration)

The above clause is to provide an alternative for buildings protected with sprinkler system. Qualified Person/Building owner shall decide which option, clause (b) or (c) i.e either double the unprotected openings or half the separation distance between the building and the relevant boundary, whichever is relevant to the building.

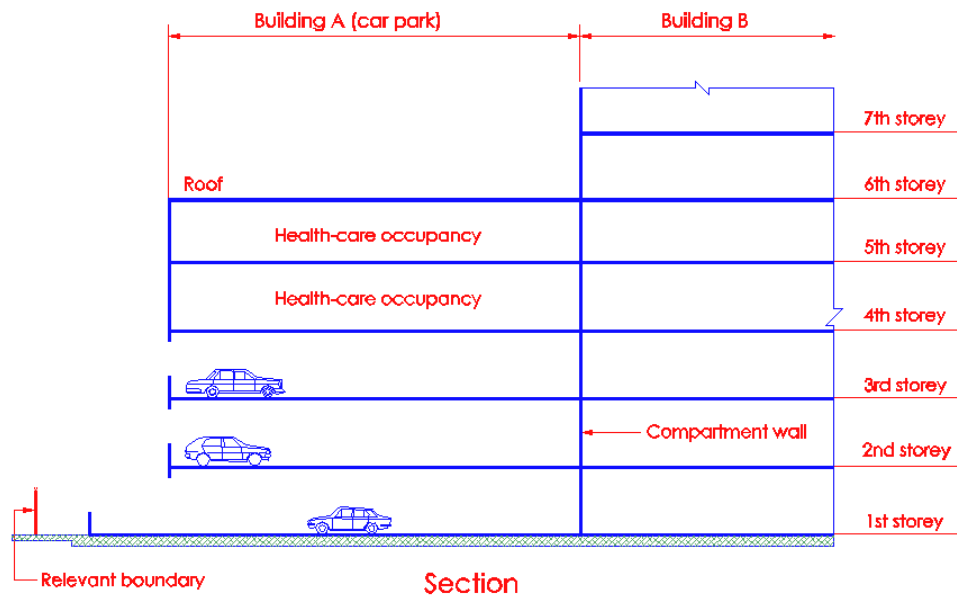

Diagram3.5.3(d)

The above clause treats car park building differently by allowing the floor having the largest extent of unprotected openings to be used for the purpose of complying with Table 1 of Appendix B. This clause grants special relaxation in relation to its distance from the lot boundary for the purpose of complying with Table 1 of appendix B.

In the above diagram, the enclosing rectangle would apply to 1<sup>st</sup> storey elevation facing the relevant boundary, instead of the whole building, which forms one compartment.

### 3.5.4 Cladding on external walls

- (a) If such cladding is situated less than 1 m from any point on the relevant boundary, it shall have surface complying with the requirements for Class '0', and
- (b) If such cladding is situated 1 m or more from the relevant boundary it shall have, if the building is more than 15 m in height, a surface complying with the requirements specified for Class '0', except that any part of such cladding below a height of 15 m from the ground may consist of timber of not less than 9 mm finished thickness or of a material having a surface which, when tested in accordance with BS 476: Part 6 have an index of performance (I) not exceeding 20.

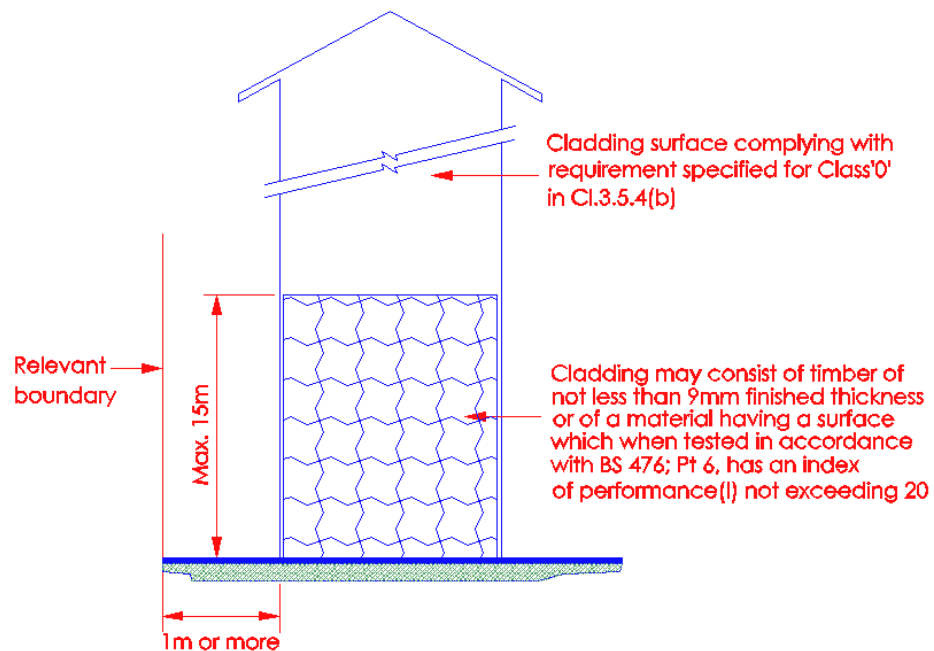

Diagram 3.5.4(a)

If such cladding is situated 1m or more from the relevant boundary and the building is more than 15m,

- (i) any part that is situated above 15m from the ground shall have a surface complying with the requirements for Class '0'.
- (ii) For explanation of index and sub-index, please see Cl.3.13.1

Reference to Part I - II of Appendix B

3.5.5 Any reference to Appendix B shall be construed as referring to the provisions of Part I of that Appendix together with the provisions of Part II.

*(No illustration)*

### 3.5.6 Buildings on land in common occupation

If two or more detached buildings are erected on land in common occupation, any external wall of any building so erected which faces an external wall of such other building, the relevant boundary shall be a notional boundary passing between those buildings and such boundary must be capable of being situated in such a position as to enable the external walls of those buildings to comply with the requirements of Cl.3.5.3.

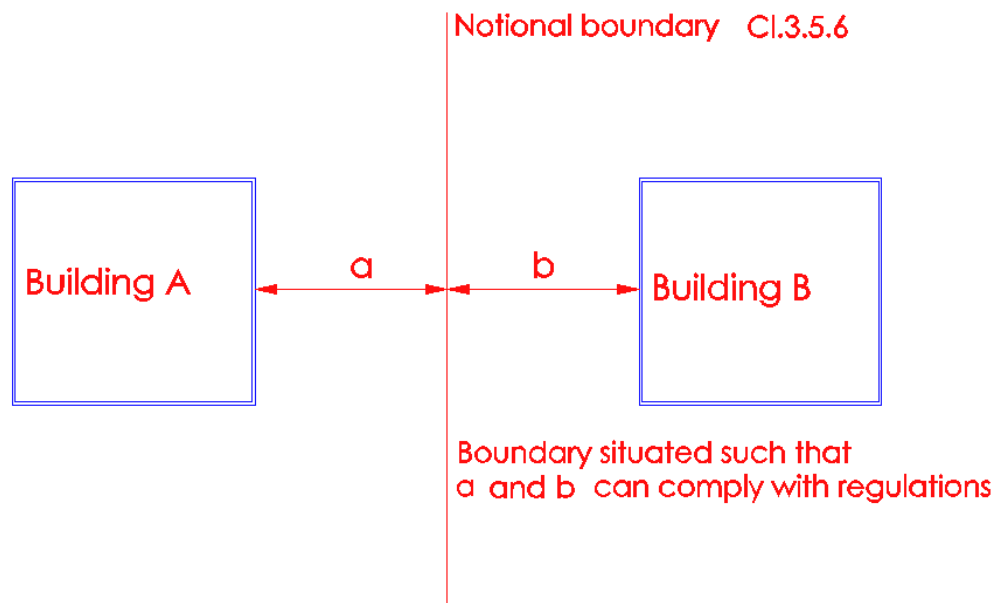

Diagram 3.5.6

- (a) *It is necessary to assume a notional boundary when two or more detached buildings are erected on land in common occupation.*
- (b) *The notional boundary is taken to exist in space between the buildings and is positioned so that the external walls of building A and B facing the notional boundary comply with the separation distance requirement in accordance with Tables of Appendix B, based on the percentage of unprotected area and the purpose group of the compartment/floor.*

- (c) *Unprotected openings shall be assessed for each building separately. The separation distance between the two buildings shall be not less than the sum of the distance each building would require to a relevant boundary ie. "a" is equal to or greater than the separation distance to the boundary for building A and "b" is equal to or greater than the separation distance to the relevant boundary for building B.*
- (d) *The notional boundary can be shifted next to external wall of building A or B, if the external wall has no unprotected areas and is constructed of non-combustible materials having the requisite period of fire resistance rating as the elements of structure of the storey compartment.*

### 3.5.7 Vertical fire spread

For high and low parts of different compartments of a building abutting each other, either one of the following requirements shall be complied with to prevent spread of fire from the roof close to and lower than the external of the higher part:

- (a) the roof over the lower part of the building shall be fire rated in accordance with the element of structure for minimum 1 hour for a distance of 5m measured horizontally from the external wall of the higher part of the building; or
- (b) the external wall of the higher part of the building overlooking the roof below shall have the necessary fire resistance rating in accordance with the element of structures for minimum 1 hour for a vertical height of not less than 9m measured from the roof of the lower part of the building.

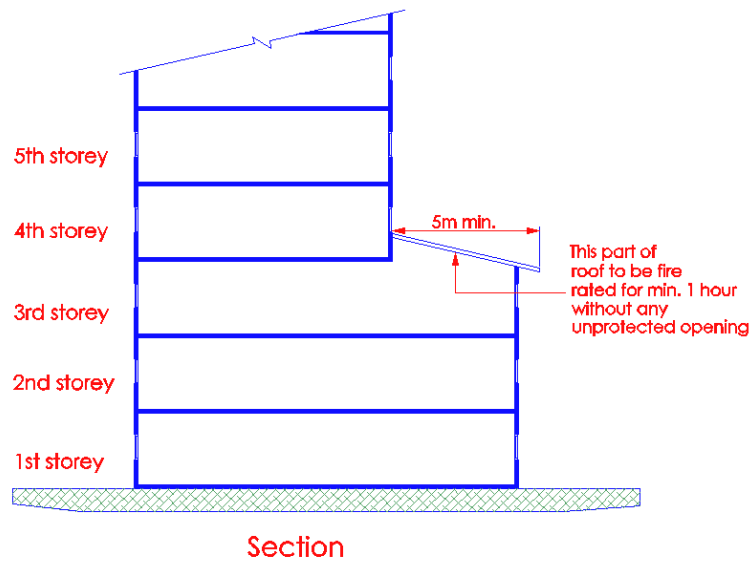

Diagram 3.5.7(a)

A fire occurring in the 3<sup>rd</sup> storey would spread vertically to 4<sup>th</sup> storey via the roof and windows. To prevent the fire spread vertically, the roof of 3<sup>rd</sup> storey should be fire rated for min. 1-hour for a distance of 5m measured horizontally from the external wall of 4<sup>th</sup> storey abutting the roof of 3<sup>rd</sup> storey. If the roof projection of 3<sup>rd</sup> storey is less than 5m, then the entire roof projection over the lower part of the building shall be fire rated with minimum 1 hour fire resistance rating.

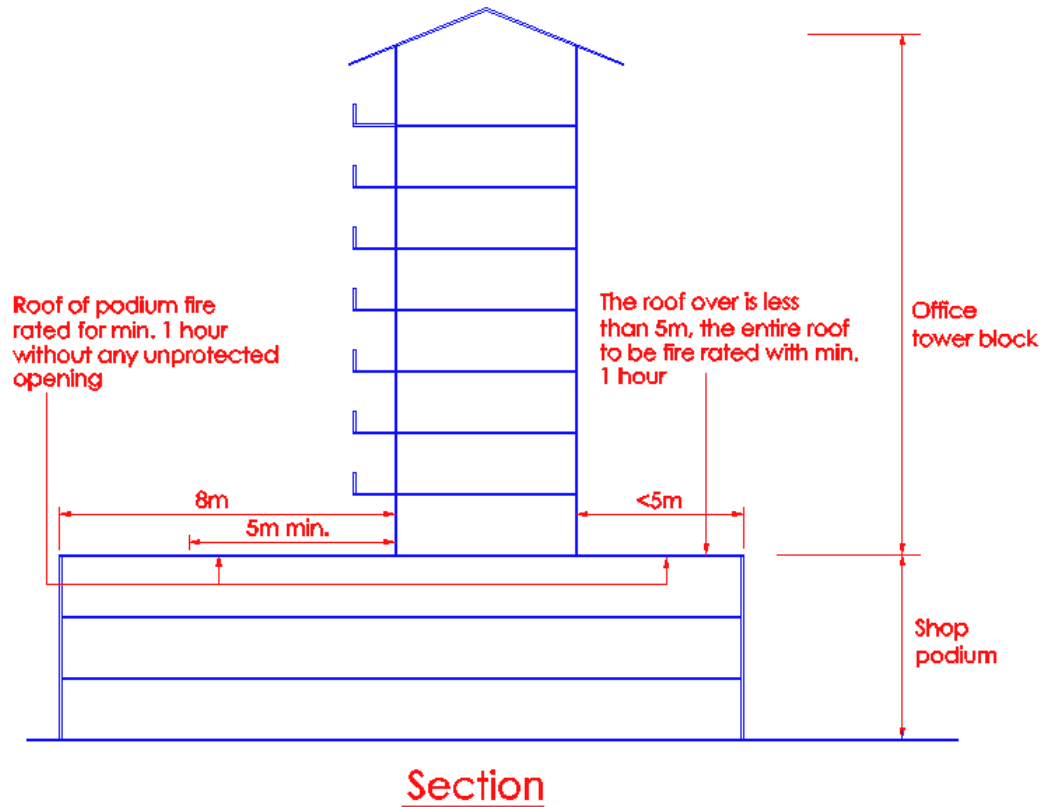

Diagram 3.5.7(b) -1



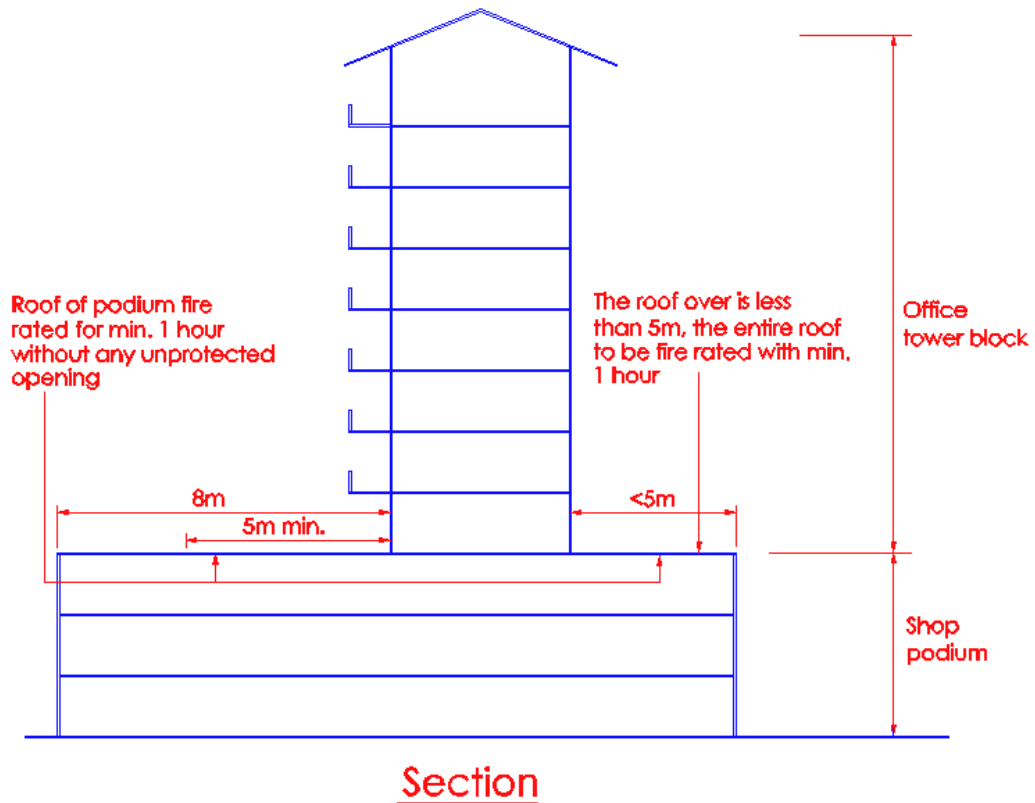

Diagram 3.5.7(b) -2

Providing fire rated wall with unprotected opening is an alternative to fire rating the roof under subclause (a).

The above 2 diagrams show the 2 ways of preventing fire spread vertically from the lower floor to the upper floors.

- 3.5.7 (c) the above requirements shall not be applicable to buildings or lower parts of the building which are sprinkler protected, or old shophouses which are subject to URA's Conservation Programme or built before 1969 referred to under cl.1.1.1 and cl.1.1.2

## 3.6 SEPARATING WALLS

### 3.6.1 Requirements of separating walls

Every separating wall shall:

- (a) Form a complete barrier in the same continuous vertical plane through the full height between the buildings it separates, including roofs and basements and shall be imperforate except for provisions of openings permitted under Cl.3.6.2, and
- (b) Have the appropriate fire resistance to comply with the requirements of Cl.3.3, and
- (c) Be constructed of non-combustible materials, together with any beam and column which form part of the wall and any structure which it carries.
- (d) Not include glass fire resisting walls.

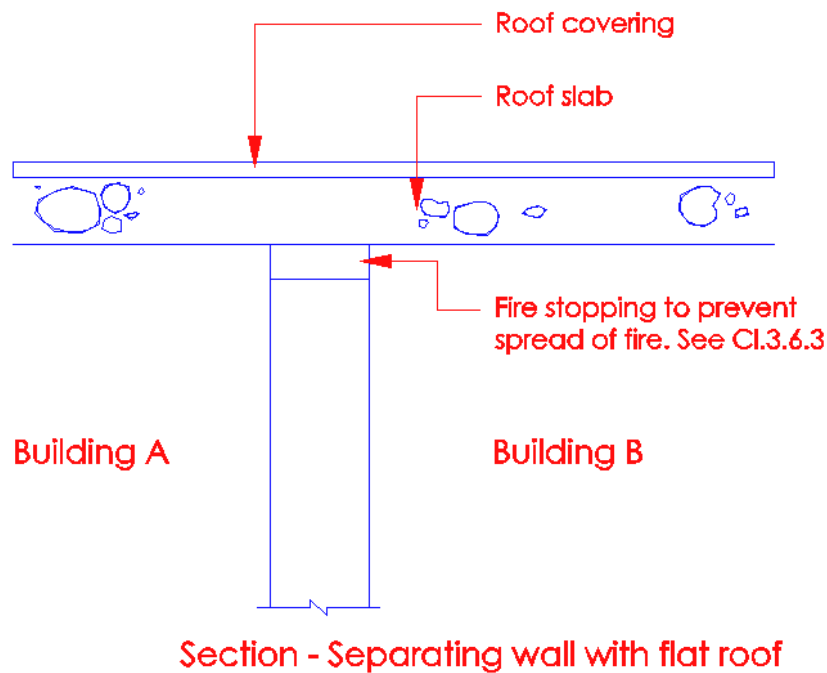

Diagram 3.6.1

Separating wall separates adjoining buildings. Separating wall may also be the common wall that separates one unit from another. It is to prevent the spread of fire from unit to unit.

*The separating wall shall have the appropriate fire resistance rating as the elements of structure of the adjoining unit having the larger floor area or cubical extent or a purpose group requiring a higher fire resistance rating as the case may be. Separating wall shall be imperforate, constructed of non-combustible materials and must have a fire resistance of not less than one hour. Openings may be formed for the passage of small pipes or where permitted as a means of escape under Cl.3.6.2. It shall not include fire resisting glass.*

*For non-sprinklered protected buildings, QPs are required to seek prior consultation with SCDF (FSSD) pertaining to wall separating institutional usage of separate ownerships/tenancies in a building.*

### 3.6.2 Openings in separating walls

A separating wall shall have no openings except for –

- (a) A door required to provide a means of escape in the event of a fire, having the same fire resistance as that required for the wall and complying with Cl. 3.9.2, or

*(No illustration)*

*Opening in the separating wall shall comply with the following conditions :*

- i) *Qp shall obtain prior approval from SCDF (FSSD) before submission of building plan.*
  - ii) *If the adjoining unit or building is under different ownership; written consent from the owner shall be obtained for submission to SCDF (FSSD).*
  - iii) *Owner is to submit a written undertaking to SCDF (FSSD) that should the opening in the separating wall is no longer required, it shall be restored to its original imperforate state.*
- (b) *A door provided for the purpose of public circulation and permitted by the Relevant Authority, having the same fire resistance as that required for the wall and complying with Cl. 3.9.2, or*

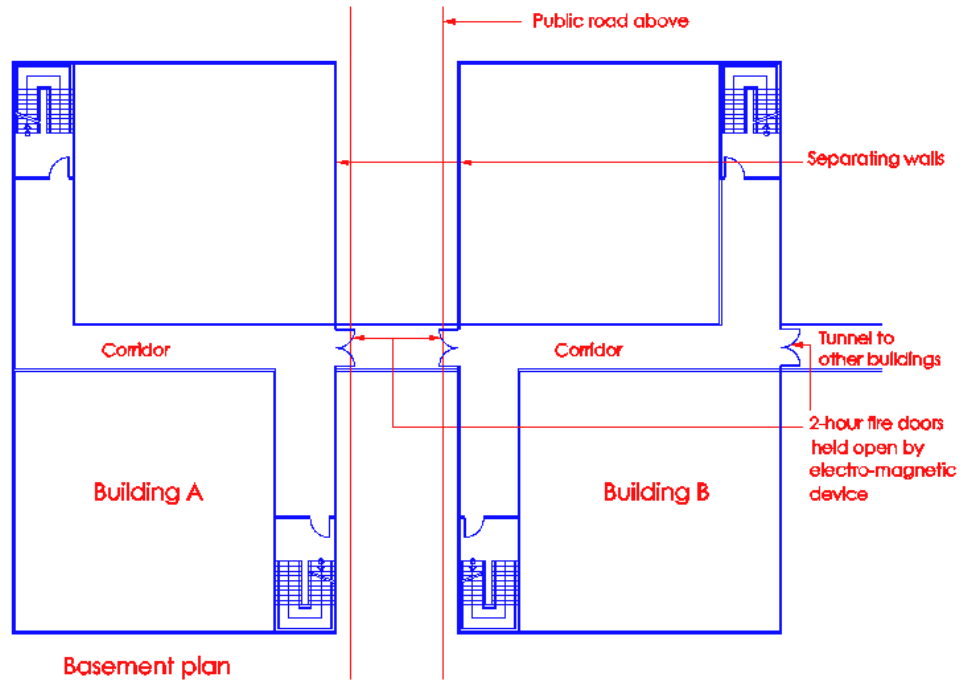

Diagram 3.6.2(b) - 1

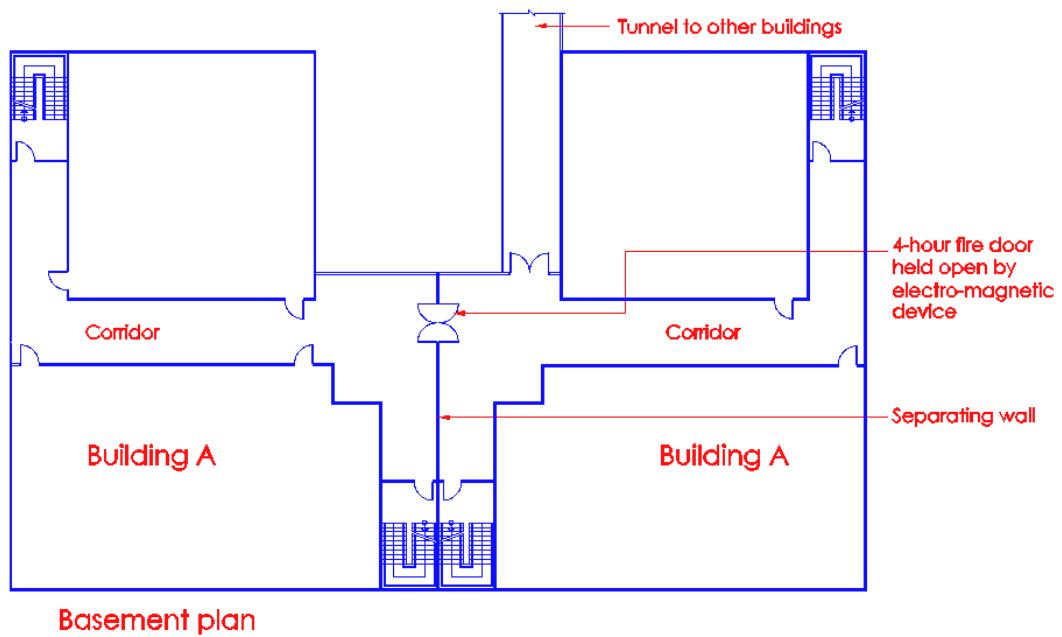

Diagram 3.6.2(b)-2

Doors are provided in separating walls to connect 2 buildings for public circulation. Prior approval shall be obtained before building plans are submitted for approval. The above provision for the purpose of public circulation shall not be taken to qualify for the requirements for the provision of area of refuge.

- (c) Opening for the passage of a pipe complying with the relevant provisions of Cl. 3.9.3.

(For illustrations see clause 3.9.3)

### 3.6.3 Separating wall - roof junction

A separating wall shall be either carried up to form a close joint with the underside of a pitched roof of non-combustible covering or carried up above the level of such roof covering. The junction between such separating wall and roof shall be properly fire-stopped so as not to render ineffective the resistance of such separating to the effects of the spread of fire.

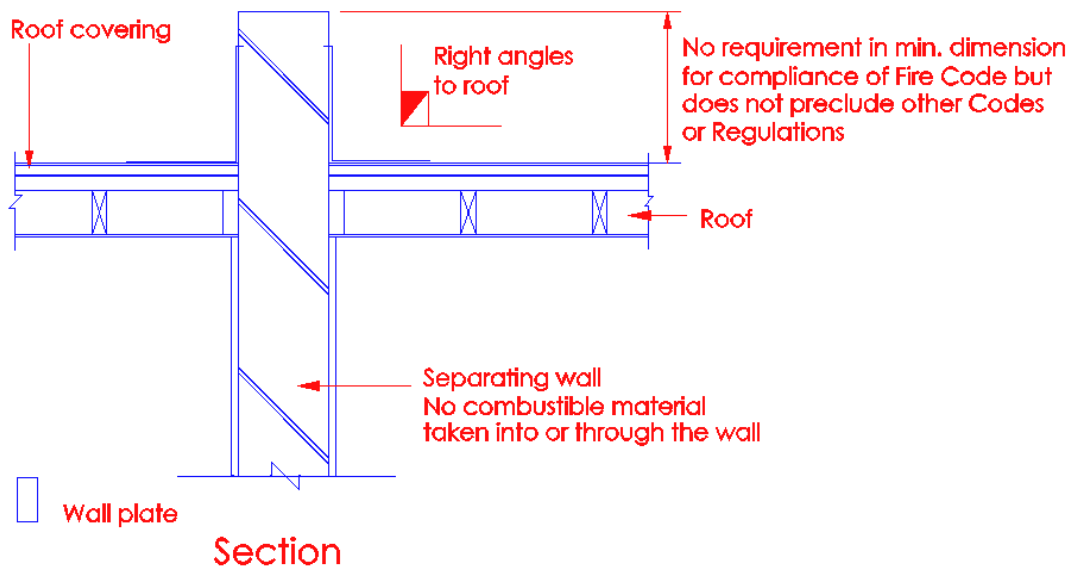

Diagram 3.6.3

Separating wall is carried right up above the roof coverings to act as a barrier to prevent fire spread over the roof level. The above clause addresses the concern at the junction of separating walls with roofs and other elements of structure to prevent fire from spreading through cracks and gaps at such junctions.

### 3.6.4 Separating wall – external wall junction

If any external wall is carried across the end of a separating wall, such external wall and separating wall shall be bonded together or the junction of such walls shall be fire-stopped to comply with the requirements of Cl.3.12

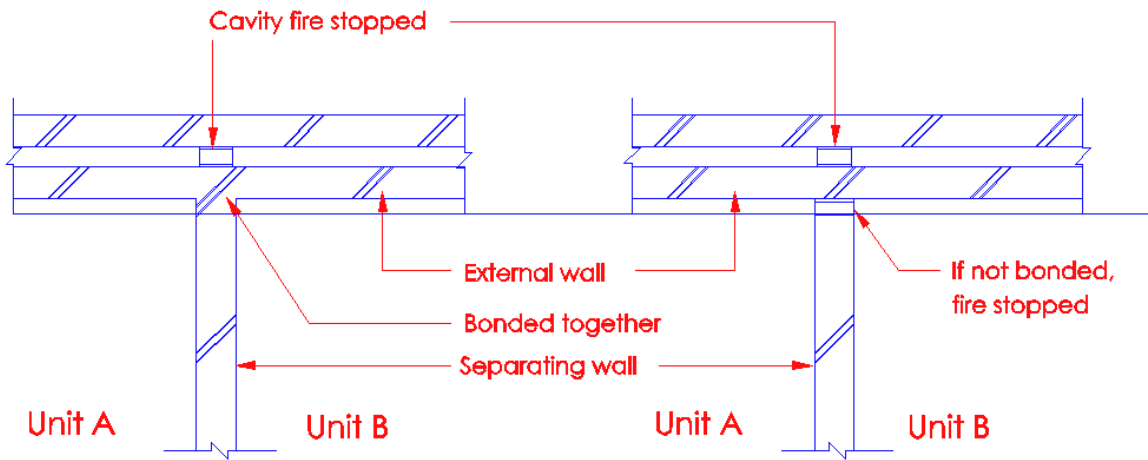

Diagram 3.6.4

### 3.6.5 Prohibition of combustible materials in separating walls

No combustible material shall be built into, carried through or carried across the ends of or carried over the top of separating walls in such a way as to render ineffective such separating walls to the effects of the spread of fire.

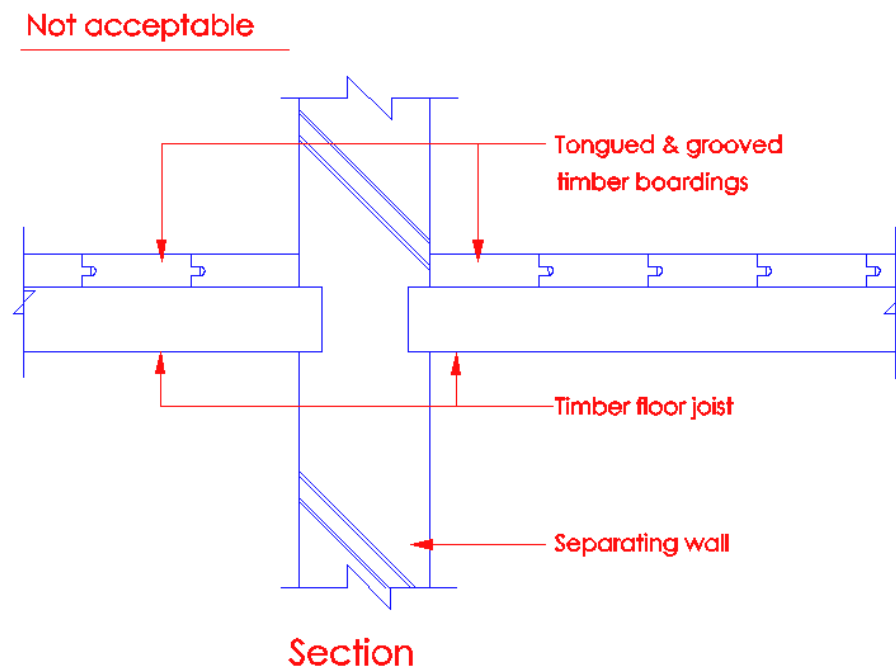

Diagram 3.6.5 – 1

*Combustible materials built into separating wall would weaken the fire resistance integrity of the wall. Separating wall must be constructed of wholly non-combustible materials, including the beam, column or other structure carrying the wall. Exception is allowed for internal linings under Cl.3.13. However, for building under conservation, it would be acceptable if the original method of construction of floor is required to be retained.*

### **3.7 COMPARTMENT WALLS AND COMPARTMENT FLOORS**

#### **3.7.1 Requirements of compartment walls and compartment floors**

Every compartment wall or compartment floor shall be required to –

- (a) Form a complete barrier to fire between the compartments it separates, and
- (b) Have the appropriate fire resistance to comply with the requirements of Cl.3.3, and
- (c) Be constructed of non-combustible materials (together with any beam or column which forms part of the wall or floor and any structure which it carries), and
- (d) Have no fire resisting glass forming part of it unless permitted under cl.3.15.13.

*(No illustration)*

*Compartment walls and floors are to be totally imperforate except for the following permitted openings :*

- (a) doors*
- (b) protected shafts*
- (c) ventilation ducts*
- (d) pipes*
- (e) chutes eg. refuse, linen*

*Compartment walls and floors are to be constructed wholly of non-combustible materials, including any beam or column, which forms part of the wall or floor and any structure, which it carries. The walls and floors shall be constructed to have the necessary fire resistance to comply with the requirements of Cl.3.3. See also Cl.3.2.5 on the provision of compartment walls and floors. Provision of fire resisting glass in compartment wall or floor is not allowed.*

### 3.7.2 Openings in compartment wall or compartment floor

A compartment wall or compartment floor shall have no openings in it, except for –

- (a) A door which has the same fire resistance rating as the compartment wall and complies with the relevant requirements of Cl. 3.4, unless permitted by other provisions of the Code, or
- (b) A protected shaft which complies with the requirements of Cl. 3.8, or
- (c) The passage of a pipe or ventilation duct, such openings in the compartment wall or compartment floor shall be protected to comply with the relevant provisions of Cl. 3.9.

*Other provisions in the code which allow fire door to have ½ the fire resistance rating of the adjoining compartment wall are :*

- (i) Doors to protecting structure under Cl.3.8.6;*
- (ii) Exit doors opening into an internal and external exit passageway under Cl.2.3.2(b)(iii) and 2.3.2(c)(iii) respectively; and*
- (iii) Exit doors opening into protected lobby under Cl.2.2.13(b).*

*Doors to protected shafts are required to have ½ the period of the fire resistance rating of the protecting structure surrounding the opening. The main reasons for the above relaxation are :*

- i) Exit doors if required to have the same period of fire resistance rating as the surrounding wall would be quite heavy. Occupants escaping into the protected staircase would need to push hard to open the doors. Besides having to overcome the weight of the doors, additional force would be required to deal with the self-closing device fitted to the doors and in certain cases, the force imposed by the staircase pressurisation system. This would slow down the evacuation process;*
- ii) A fire that breaks into the shaft at one level would need to break out again at another level. The aggregate rating of the 2 doors, each at different level, would be considered as acceptable; and*
- iii) Door openings in protecting structures would be limited in size, hence the potential source of weakness in the overall integrity of the shaft is limited.*

*In other situation, the door within compartment wall shall have the same fire resistance as the compartment wall. This is applicable to trap doors in floors.*



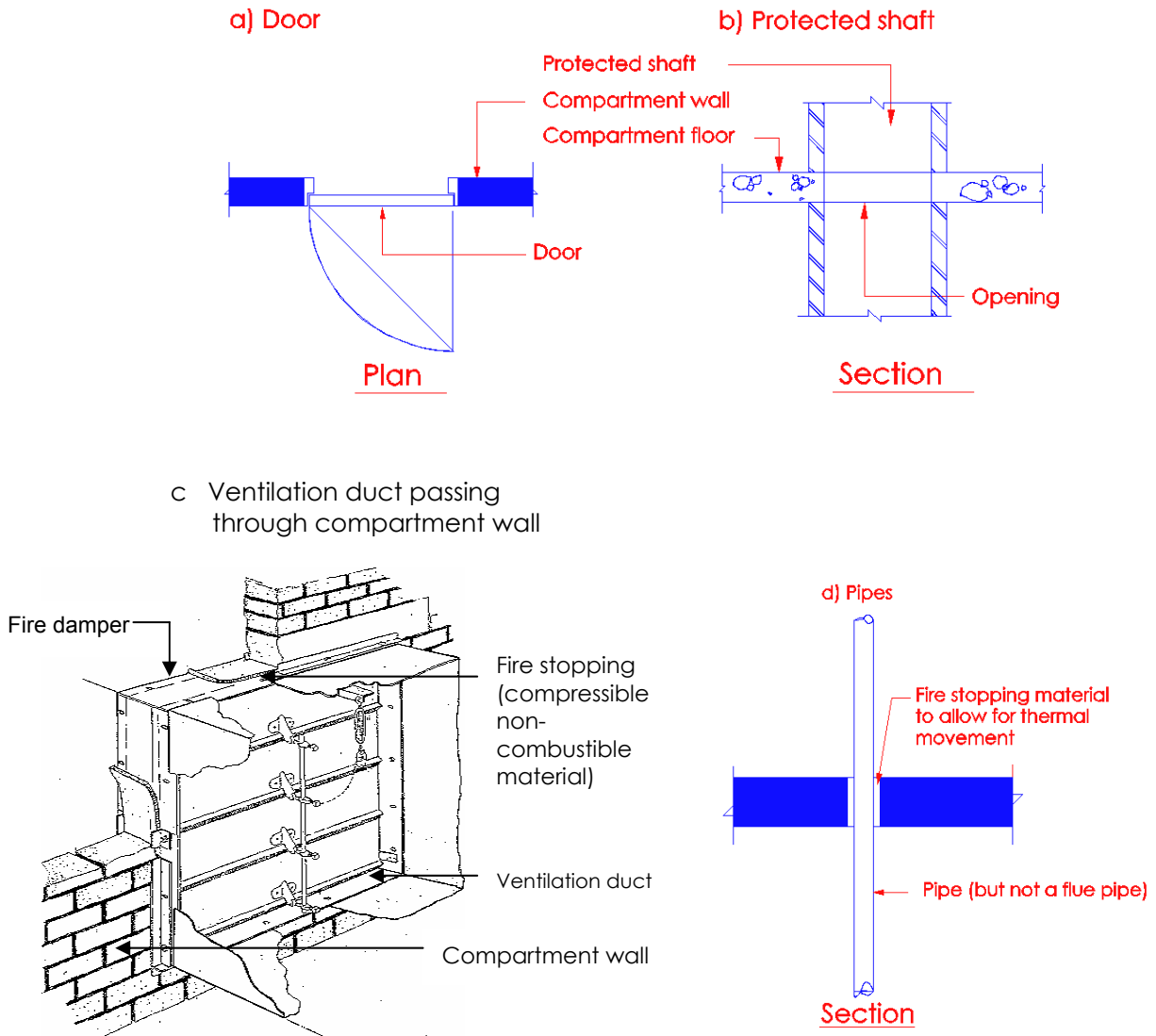

Diagram 3.7.2(c)

Compartment walls and floors are required to be totally imperforate except for the abovementioned openings to permit movement of people, air, services etc in the building.

### 3.7.3 Junction with other structures

- (a) Where a compartment wall or compartment floor forms a junction with any structure comprising any other compartment wall, or any external wall, separating wall or structure enclosing a protected shaft, such structures shall be bonded together at the junctions or the junctions shall be fire-stopped to comply with the requirements of Cl. 3.12.

b) Opening in curtain walling

The opening occurring at the junction between the edge of a structural floor and the curtain walling shall be sealed to prevent the spread of smoke and flame from the lower floor to the upper floor via the opening. Materials to be used for sealing the opening shall have the requisite fire resistance rating as the elements of structure.

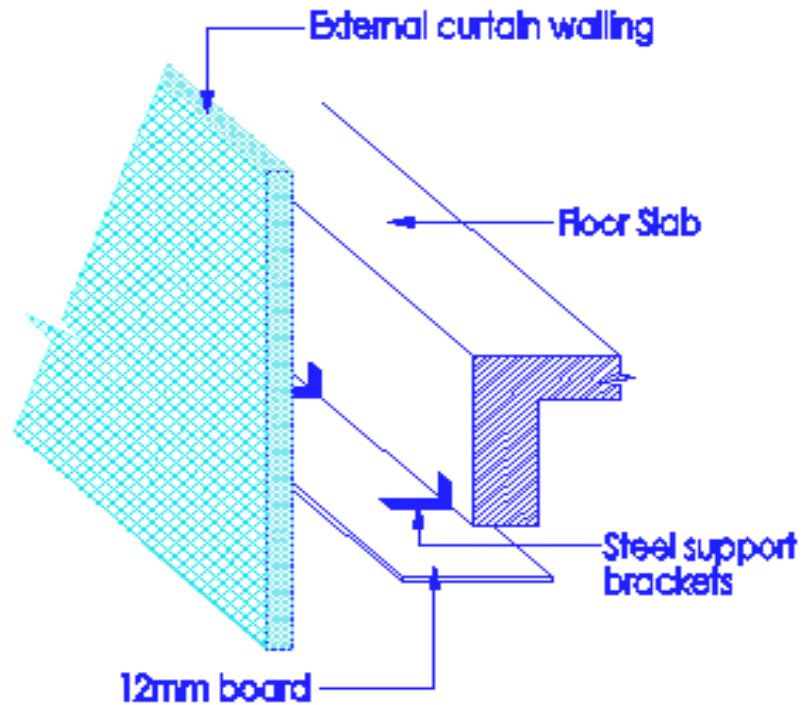

Diagram 3.7.3(b)

3.7.4 Compartment wall – roof junctions

Where a compartment wall forms a junction with a roof, such compartment wall shall be carried up to form a close joint with the underside of the roof and shall be properly fire-stopped or shall be carried up above the level of the roof covering and the junction between such compartment wall and roof shall be properly fire – stopped so as not to render ineffective the resistance of such compartment wall to the effects of the spread of fire.

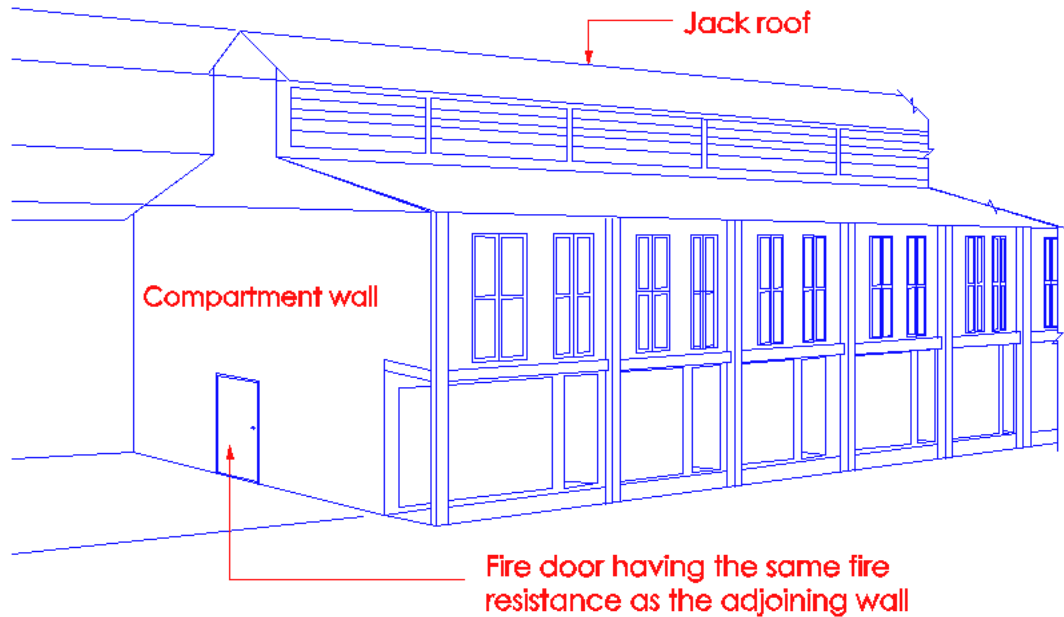

Diagram 3.7.4

*Compartment wall shall be brought up to the underside of the roof coverings, including jack roof to complete the fire separation and to prevent fire spread from compartment to compartment. See also sub-clause 3.6.3 (separating wall – roof junction)*

### 3.7.5 Prohibition of combustible materials

No combustible material shall be built into, carried through or carried across the ends of any compartment wall or compartment floor or carried over the top of any compartment wall in such a manner as to render ineffective the resistance of such wall or floor to the effects of the spread of fire.

*See subclause 3.6.5 (Prohibition of combustible material in separating wall)*

### 3.7.6 Non-combustibility of compartment walls or floors

Every compartment wall or compartment floor shall be constructed of non-combustible materials, unless permitted by the Relevant Authority.

*(No illustration)*

*Construction of compartment walls and floors shall be constructed entirely of non-combustible material. However, there were exceptions specially allowed for under the conservation programme. The exemption was an understanding between SCDF (FSSD) and URA. As a general guide, Qps are required to seek prior consultation with SCDF (FSSD ) before making BP submission.*

*Any structural members carrying compartment walls or floors must also comply with the requirement of non-combustibility. Apart from the contribution made by suspended ceilings under CL.3.3.6, the fire resistance of the structural members must be attained without assistance from any combustible material (with the exception of buildings designated for conservation).*

### **3.8 PROTECTED SHAFTS**

#### 3.8.1 Purpose of protected shaft

A protected shaft shall not be used for any purpose additional to those given as defined under Cl. 1.2.47.

All services such as, pipe/duct installation should not be located inside protected staircase. Likewise, no washroom is allowed to be located inside protected staircase.

*(No illustration)*

*The purposes of providing protected shaft are to delay or prevent the spread of fire between compartments through which staircases or other shafts pass directly and to enable people or things or air to pass between compartments. The purpose of each shaft is as follows :*

- i) The staircase shaft is a vertical shaft which enable the passage of movements of people.*
- ii) The service shaft enables the passage of cable, building service ducts/pipes.*
- iii) The lift shaft enables the movements of lift cars.*

*“Protected Shafts” include staircase, lift shafts, chutes, ducts or any other shaft enabling movement of people, goods, air, pipes, etc.*

*Protecting structures shall be treated as elements of structure for the purpose of determining the period of fire resistance rating.*

### 3.8.2 Requirements of protected shaft

Every protected shaft shall be required to –

- (a) Form a complete barrier to fire between the different compartments which the shaft connects, and
- (b) Have the appropriate fire resistance to comply with the requirements of Cl. 3.3, and
- (c) Be constructed of non-combustible material (together with any beam or column which forms part of the enclosure and any structure which carries it).

#### Defining protecting structures

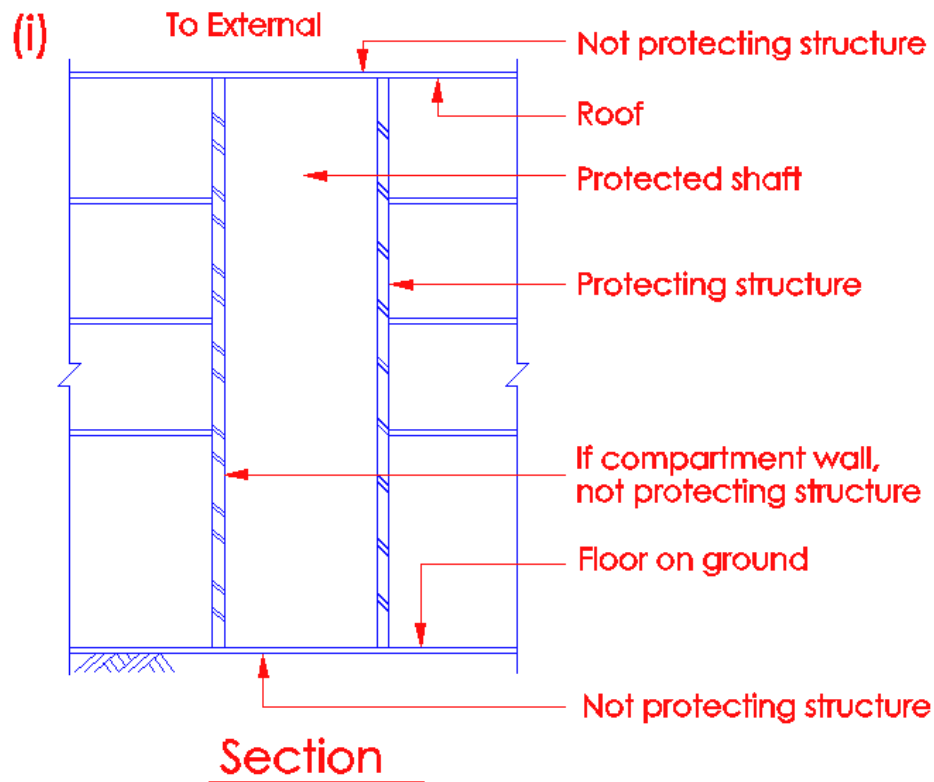

Diagram 3.8.2 - 1

Protected shafts penetrate across compartments or floors in a building. They can be shafts carrying utilities (piping, electrical and telecommunication cables etc) or service shafts carrying lifts and exit staircases. The enclosing walls and floors to the protected shaft shall be constructed of non-combustible materials, including any beam or column, which forms part of the enclosure.

In the above diagram, a protected shaft is enclosed at the top by roof slab, the sides by fire rated walls and the bottom by the ground floor slab. The protecting structures to the shaft would exclude the roof slab, which is exposed to the external, the ground floor slab, which is in contact with the ground and any compartment wall, which separates one compartment from another.

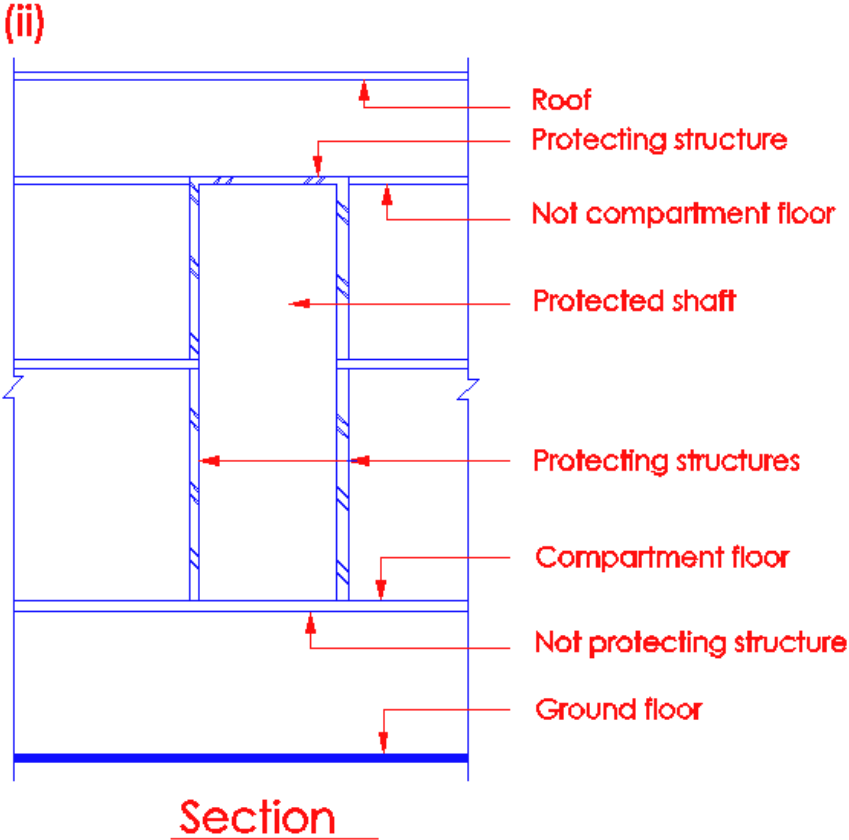

Diagram 3.8.2 - 2

Protected shaft is enclosed by internal walls, ceiling and floor. Protecting structures will include the walls and slab above; and the floor at the base of shaft is excluded, because it is a compartment floor.

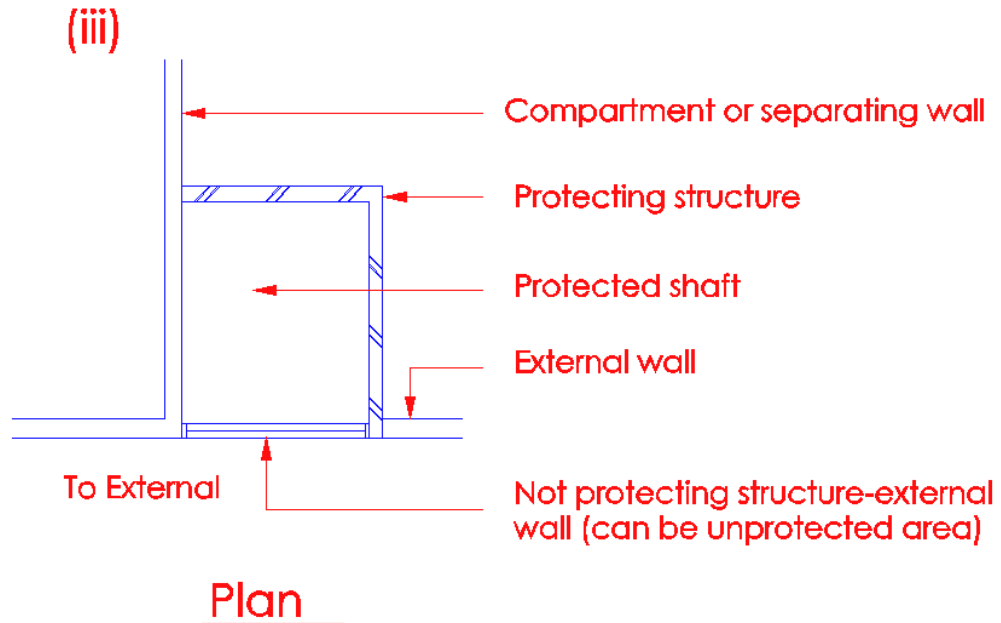

Diagram 3.8.2 - 3

Protected shaft is located against an external wall. The protecting structures will include internal walls, which are not compartment or separating wall.

See Cl.1.2.48 under Definition (Volume 1)

Where the protection afforded to a compartment is penetrated to allow the movement of people, goods or anything else between compartments by means of eg. a staircase, lift or duct, the protection to the compartment must not be lowered or diminished. This is achieved by enclosing the means of transportation from one compartment to another in a protected shaft which is so constructed that any penetration of the enclosures to the shaft poses no direct or indirect threat to the compartments connected by the shaft. Hence, the term "protected shaft" and "protecting structure" for the structure enclosing such a shaft. The elements enclosing the shaft (unless formed by adjacent external walls) are compartment walls and floors.

Diagram 3.8.2 - 3 illustrates a shaft, which is enclosed by compartment or separating wall, external wall and internal walls called protecting structure. The fire resistance of the compartment or separating wall should be based on the size of the floor area or cubical extent of the adjoining larger compartment and shall not be less than 1-hour

The fire resistance of the external wall would be determined by the separation distance requirements under Cl.3.5. The external wall is not a protecting structure and could be fully unprotected areas having no fire resistance. The remaining 2 walls of the shaft are protecting structure which must be imperforate except for certain permitted openings, eg. inspection doors which need to have fire resistance equivalent to half that of the protecting structure. All protecting structure shall be constructed of non-combustible material except for surface linings, which shall comply with Cl.3.13. The fire resistance of the protecting structures shall be that for the elements of structure of the building.

*Protecting structures exclude external wall. External walls need not have fire resistance rating, subject to complying with Cl. 3.5 to be unprotected areas*

### 3.8.3 Openings in protected shaft

A protected shaft shall have no openings in its enclosure, except-

- (a) In the case of any part of the enclosure which is formed by a separating wall, any opening which complies with the requirements of Cl.3.6 for separating walls, or
- (b) In the case of any part of the enclosure which is formed by a compartment wall or a compartment floor, any opening which complies with the requirements of Cl.3.7 for compartment wall or compartment floor, or
- (c) In the case of any part of the enclosure which is formed by the protecting structure-
  - (i) a door which has the appropriate fire resistance to comply with the requirements of Cl.3.4 for test of fire resistance, or otherwise permitted by provision of Cl.3.8.6, or
  - (ii) the passage of a pipe, excluding protecting structure to exit staircase and exit passageway, or
  - (iii) inlets to and outlets from and opening for the duct, if the shaft contains or serves as a ventilation duct

Such openings in the protected shaft shall be protected to comply with the relevant provisions of Cl.3.9 for protection of openings.



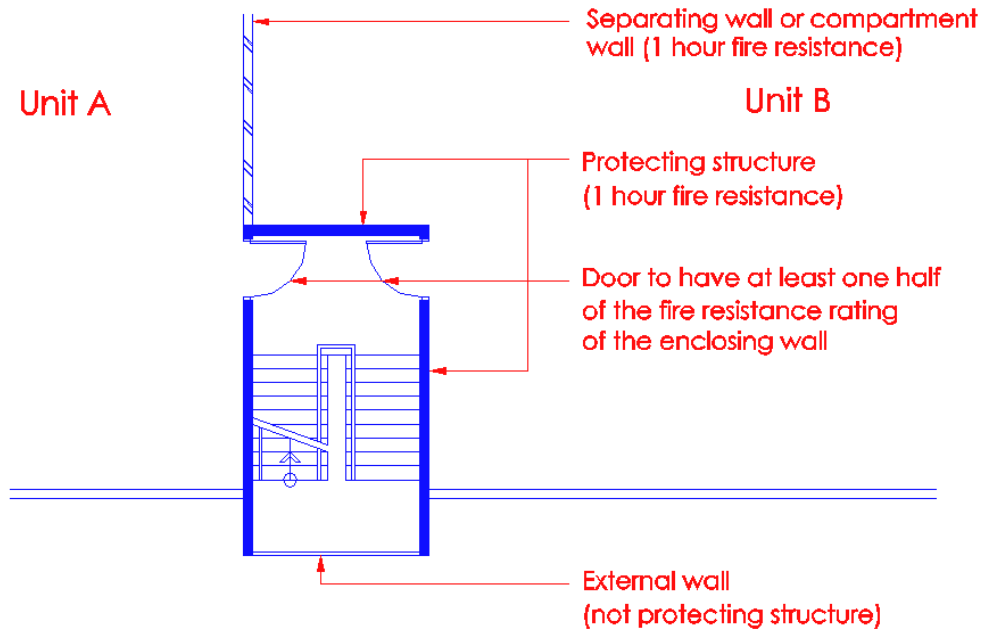

Diagram 3.8.3 (a)

*Protected shaft bounded on three sides by protecting structure and fourth side by an external wall. Permitted opening to each unit shall be protected by a door of at least one half of the fire resistance rating of the enclosing wall, or half an hour, whichever is the greater. The aggregate fire resistance of the 2 doors shall not be less than the fire resistance of the protecting structure.*

Permitted openings in protected shaft

*To prevent fire spread from duct to duct, a fire rated barrier is provided between ducts. See cl.3.8.9 for further information. Openings created in protecting structure for ventilation duct shall be provided with automatic fire damper as shown in detail B.*

Shaft containing ventilation duct/pipes

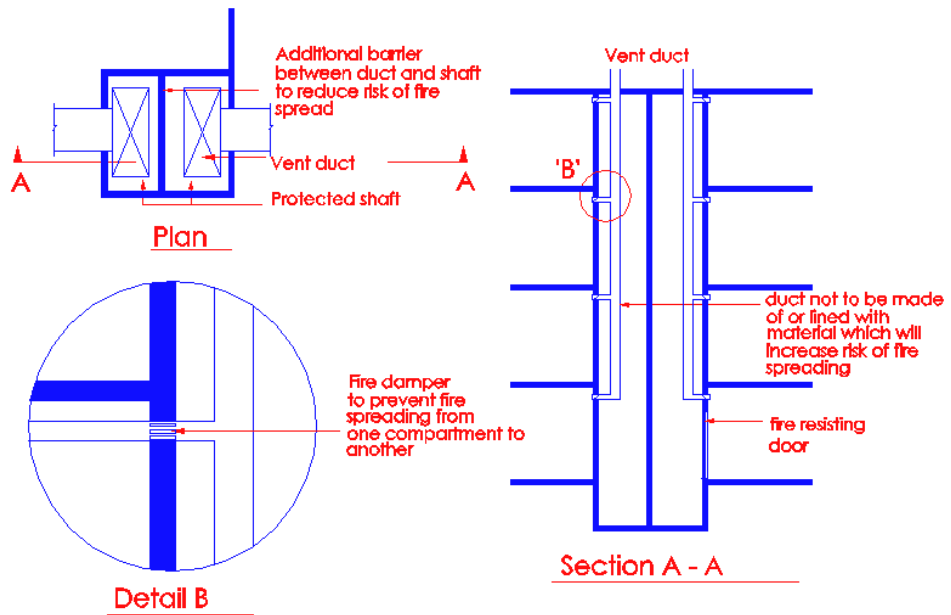

Diagram 3.8.3(c) - 1

Shaft containing gas pipe

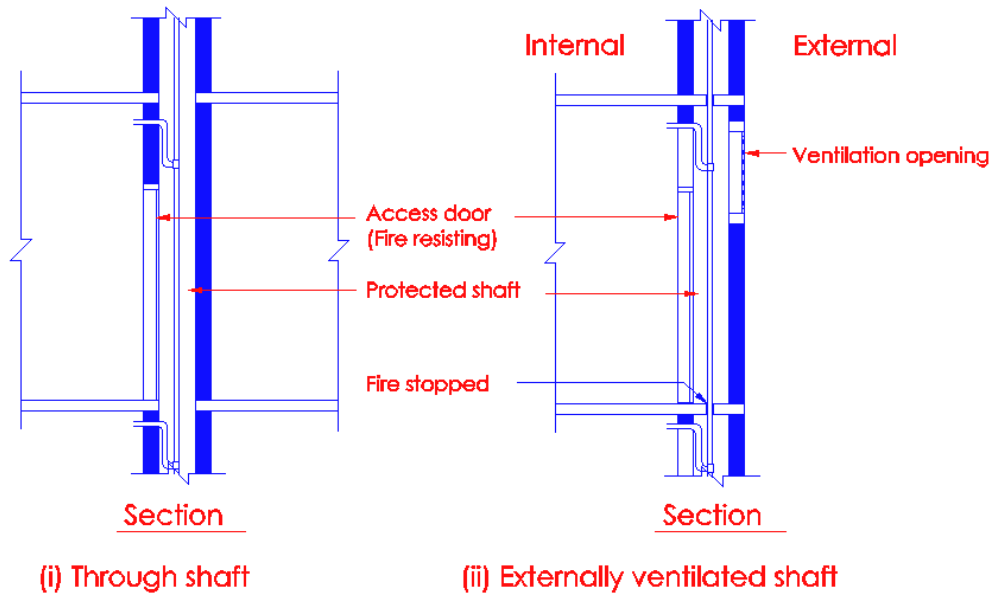

Diagram 3.8.3(c) - 2

Openings in gas pipe shafts are acceptable subject to restriction under CP 51. The above illustrations show 2 ways that can vent any leakage of gas in the shaft to the exterior.

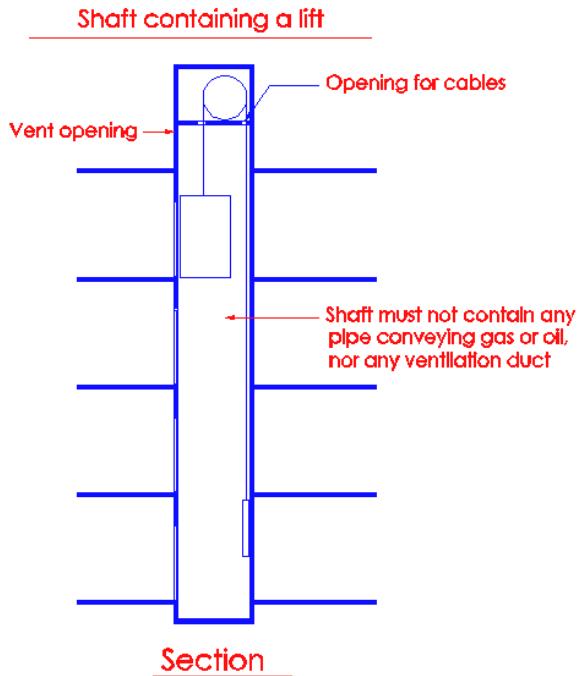

Diagram 3.8.3(c) - 3

Services not serving the lift shall not be located inside the lift shaft. Fire resisting doors to comply with Cl.3.9.2 and shall have ½ hour fire resistance or half the resistance of the enclosing walls, whichever is the greater.

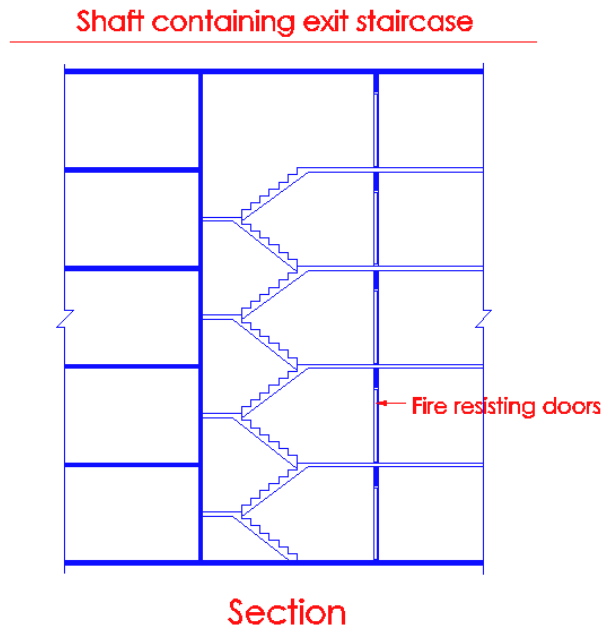

Diagram 3.8.3(c) - 4

Staircase shaft must not contain any pipe conveying gas or oil. Any ventilation duct or services, which are not serving the staircase, are not allowed to be located in the shaft.

- 1) Any opening in compartment floor/wall would constitute a break in compartmentation. Therefore even small service pipes must be enclosed in protected shaft.
- 2) However, clause 3.9 allows pipe size not greater than those sizes provided in Table 3.9A to be unprotected, provided the pipes are to be spaced at min. 50mm apart or half the diameter of the larger pipe, whichever is larger. This is to avoid clustering of pipes which would weaken the compartment floor or wall.
- 3) Openings in compartment floors to accommodate staircases, lifts and services form a vertical shaft which can become a ready means of passage of fire from one storey to another, accentuated by the flue effect created by a fire.
- 4) Hence, protected shafts are needed to maintain the overall fire integrity of the building. However, these shafts need to have door openings for movement of people, eg. staircase, lifts and maintenance purposes in the case of shafts containing services. All the door openings to protected shaft are considered the sources of weakness in the integrity of the shafts and they must be protected and kept small.

#### Door openings

- 5) Doors in protected shaft must have at least ½-hour fire resistance rating or half the fire resistance of the protecting structure whichever is greater.
- 6) Door provided in protected shaft is of limited size and therefore of limited risks.
- 7) The primary purpose of protecting structure is to provide the compartmentation between floors. As such the structure shall have full fire resistance as the elements of structure. The relaxation on fire resistance accorded to fire doors shall not be extended to the protecting structure ie. halve the fire resistance of the elements of structure. The main reason is that by halving the fire resistance of protecting structure, the threat of failure and collapse of the enclosing walls would be greater in times of fire emergency and should the walls collapse, large opening would be created in the shaft to permit the spread of fire and smoke, which is not acceptable. As to door openings in protected shaft, the eventual failure of the fire door is considered acceptable owing to the limited door opening size. See diagram 3.8.3 – 3 & 4.

#### Ventilation ducts

- 8) Ventilation ducts are usually constructed of sheet metal, which do not have fire resistance and therefore should a fire occur, they will quickly distort and collapse leaving a hole in any wall through which they pass. Conversely, a fire occurring in the duct could also cause collapse.
- 9) Therefore, where the duct penetrates the protected shaft, a fire damper should be fitted at the opening of the protecting structure. The fire damper shall be capable of sealing the opening in the protecting structure and be installed independently of the duct trunking. In this way, the fire damper would not be affected by collapse of duct work and be able to maintain the fire integrity of the shaft. See diagram 3.8.3(c) - 3 & 4.

### Pipes

- 10) *Where pipes are contained within a protected shaft, the problem of maintaining the integrity of the fire compartment is made simple, irrespective whether the pipes are made of UPVC or combustible materials. However, for gas pipes or pipes containing combustible liquids, they shall be located in separate shafts.*
- 11) *The construction of gas pipes shaft is different from other shafts owing to the need to provide through shaft or external ventilation. Gas pipe shaft shall comply fully with SS CP 51. See diagram 3.8.3(c) – 2.*

### General

- 12) *In order to maintain the level of integrity of protected shafts, openings in protected shafts shall be restricted to the following :*
  - a) *Openings for pipe*
  - b) *Openings for ventilation ducts except staircase*
  - c) *Access openings for electrical cables shaft except staircase*
  - d) *Openings for chutes, linen or refuse except staircase.*

#### 3.8.4 Non-combustibility of protecting structures

Every protecting structure shall be constructed wholly of non-combustible materials except that floor, wall and ceiling finishes which do not contribute to the fire resistance of such protecting structure may not be required to comply with the requirements for non-combustibility.

*(No illustration)*

*The requirement that all protecting structures shall be constructed of non-combustible materials is also spelled out under Cl.3.8.2. As to the provision of combustible finishes to floor, wall and ceiling, it must be observed that such provision will not be permitted inside protected shafts that are used for the passage of people such as exit staircases, exit passageways and lift under Cl.3.10.4 and Cl.3.13.6.*

### 3.8.5 Ventilation of protected shaft

Ventilation of protected shaft shall comply with the following:

- (a) A protected shaft used for the passage of people, such as exit staircases, shall be ventilated to comply with the relevant provisions of the Code.
- (b) A protected shaft containing a pipe conveying gas shall be adequately ventilated directly to the outside air or other modes of ventilation allowed under SS CP 51.

*(No illustration)*

*Protected shaft used for passage of people, such as exit staircases shall be provided with adequate natural ventilation by fixed openings in the external walls. Such openings shall have an area of not less than 10 per cent of the floor area per floor of the staircase. Alternatively, the staircase can be mechanically ventilated under Cl.2.3.3(f). However, for internal exit staircase serving more than 4 storeys, the supply air shall be mechanically conveyed via a vertical duct extending through the staircase height and discharging from outlets distributed at alternate floor. Where the internal exit staircase exceeds 24m in height without provision for natural ventilation, the staircase shall be pressurised in accordance with Cl.2.3.3(g).*

*The mechanical ventilation system to internal staircase serving more than 4 storeys and the pressurization system to internal exit staircase exceeding 24m shall be connected to emergency power supply. In addition, a remote manual start-stop switch shall be made available to fire fighters at the fire command centre, or at the fire indicating board if there is no fire command centre. The start-stop switch provides the fire fighter a quick means to shut-off the fans should it be detected that smoke had been drawn into the staircase by the fresh air supply fan.*

*A protected shaft conveying piped flammable gas should be adequately ventilated directly to the outside air by ventilation openings at high and low level in the shaft or comply with the modes of ventilation allowed in CP51. All gas pipe installations shall be vetted and approved by acceptable organisation (example: Powergas) before any works can be carried out on site.*

### 3.8.6 Doors in protecting structures

Any door fitted in an opening in protecting structure shall have fire resistance for not less than half the period required by other provisions of the Code for the protecting structure surrounding the opening.

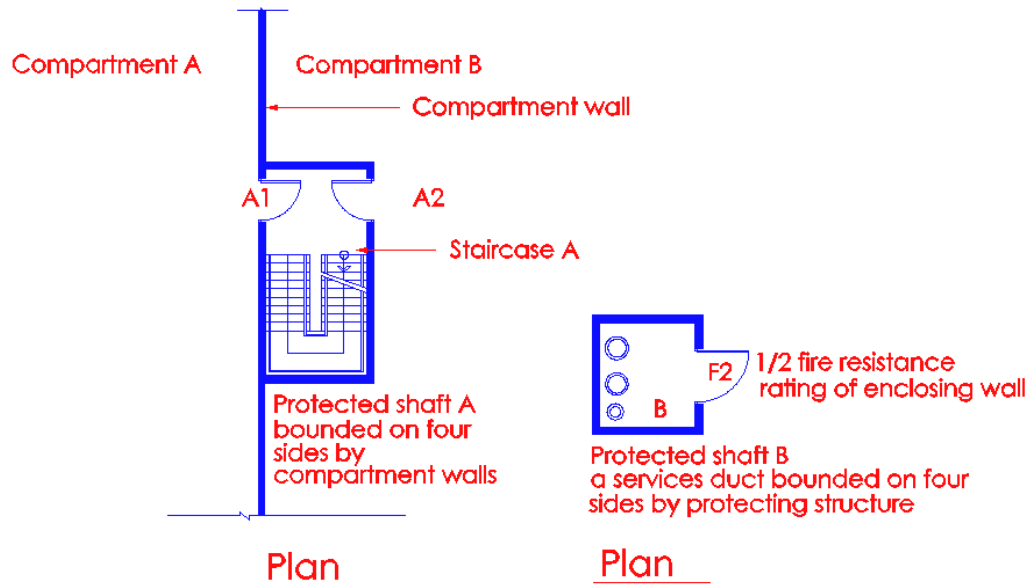

Diagram 3.8.6

Protected shaft A serves 2 compartments. Compartment A could be a common area eg. lounge and compartment B in an office unit.

All doors in shaft A & B shall have the fire resistance rating of half that of the enclosing protecting structures to the shafts, but shall never be less than half hour. See also Cl. 3.8.3 for further explanation.

Door A1 is opening in the direction of exit travel, whereas door A2 is the entrance door of the health care occupancy unit, which swings inward. The number of exit door openings in a protected shaft containing an exit staircase shall not exceed two per floor. This is to prevent additional openings from weakening the integrity of the protecting structure.

The aggregate fire resistance of door A1 and A2 shall not be less than that of the compartment wall or the protecting structures to the shaft. This is to ensure that the fire resistance between compartment A and B is not reduced at the door openings.

Door A1 can be held in the open position provided it is fitted with electro-magnetic or electro-mechanical device. See Cl.1.2.20 in Volume I.

Exception :

Any door fitted to an opening in protecting structure of a shaft containing services such as electrical cables, pipes, ducts would not need to have the fire resistance rating if the door is located along the wall facing the external corridor.

### 3.8.7 Protected shaft containing exit staircase

A protected shaft which contains an exit staircase shall comply with the following:

- (a) It shall not contain any pipe conveying gas or combustible liquid.
- (b) It shall not contain any services that are not solely serving the same exit staircase except for:
  - (i) cut-off sprinkler and pipe for that staircase; and
  - (ii) UPVC or cast iron rain water downpipes serving the roof directly above the exit staircase, and not routed through anywhere outside the staircase.
- (c) The protecting structure shall be constructed of masonry, or drywall. If drywall construction is used, the following conditions shall be complied with :
  - (i) Drywall shall be non-combustible; and
  - (ii) Drywall shall have fire resistance for not less than the relevant period specified in Table 3.3A having regard to the purpose group of the building of which it forms a part and the dimension specified in that Table; and
  - (iii) Drywall shall meet the criteria, in terms of impact and deflection performance, when subject to the tests of BS 5588 Pt 5 Appendix A and BS 5234 Pt 2; and
  - (iv) Drywall shall meet the criteria, in terms of water absorption and bending strength performance, when subject to the test of BS 1230 Pt 1 (for gypsum plaster board) or ISO 1896 (for calcium silicate or cement board); and
  - (v) The building shall have at least two independent exit staircase shafts (scissors staircases are considered as single shaft).



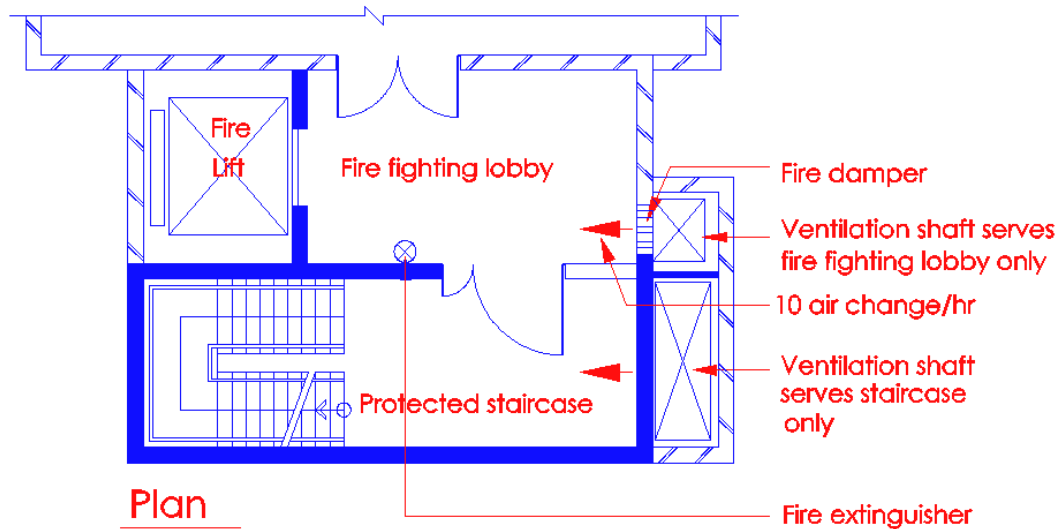

Diagram 3.8.7(c)

An exit staircase designated as fire fighting staircase in a building which exceeds 24m in habitable height has to be complemented by fire lift and fire fighting lobby. Separate ventilation shafts are required to be provided for the staircase and fire fighting lobby.

Exit staircases serving any building irrespective of the height, shall be devoid of combustible wall, floor and ceiling finishes. Building services, which are not solely serving the exit staircase, shall not be allowed to be routed through or inside the staircase. This is to prevent any possibilities of a fire occurring inside the staircase and the spread of fire into the staircase via the services such as electrical cables, ducts, combustible pipes, etc. Clause 6.2.2 of the Fire Code allows vertical stack of rising main and landing valve to be located inside the staircase as a last resort where smoke-stop lobby and common area outside the staircase are not available. Clause 2.4.3 of SS CP 10 allows sub-alarm panels to be located in the exit staircase provided there is no fire lift lobby or smoke-stop lobby in the building. The fire alarm cables shall be in metal conduit or trunking. This relaxation shall not apply to buildings, which are more than 4 storeys in height where provision of smoke-stop lobby is a requirement.

The exit staircases are the means of escape in fire emergencies. All occupants must use the staircases to evacuate safely from any storey level to the final exits at ground level. With the staircase fully packed with evacuating occupants during an emergency, the staircase must be maintained safe from smoke, heat and fire throughout the fire resistance period of the enclosing protecting structures to the staircase. In view of the above and to prevent any mechanical damage, masonry construction to the protecting structure is required. An exception is allowed under Cl.3.8.9(d) for residential buildings of up to 4 storeys.

### 3.8.8 Lift shaft

A protected shaft which contains a lift shall comply with the following:

- (a) It shall not contain any pipe conveying gas or combustible liquid, other than those in the mechanism of a hydraulic lift.
- 3.8.8 (b) The protecting structure shall be constructed of masonry, or drywall. If drywall construction is used, the following conditions shall be complied with :
- (i) Drywall shall be non-combustible; and
  - (ii) Drywall shall have fire resistance for not less than the relevant period specified in Table 3.3A having regard to the purpose group of the building of which it forms a part and the dimension specified in that Table; and
  - (iii) Drywall shall meet the criteria, in terms of impact and deflection performance, when subject to the tests of BS 5588 Pt 5 Appendix A and BS 5234 Pt 2; and
  - (iv) Drywall shall meet the criteria, in terms of water absorption and bending strength performance, when subject to the test of BS 1230 Pt 1 (for gypsum plaster board) or ISO 1896 (for calcium silicate or cement board); and
  - (v) Drywall shall meet the criteria of Cyclic Loading and Dynamic test as specified under Cl. 3.3 of Building Code of Australia Specification C 1.8.

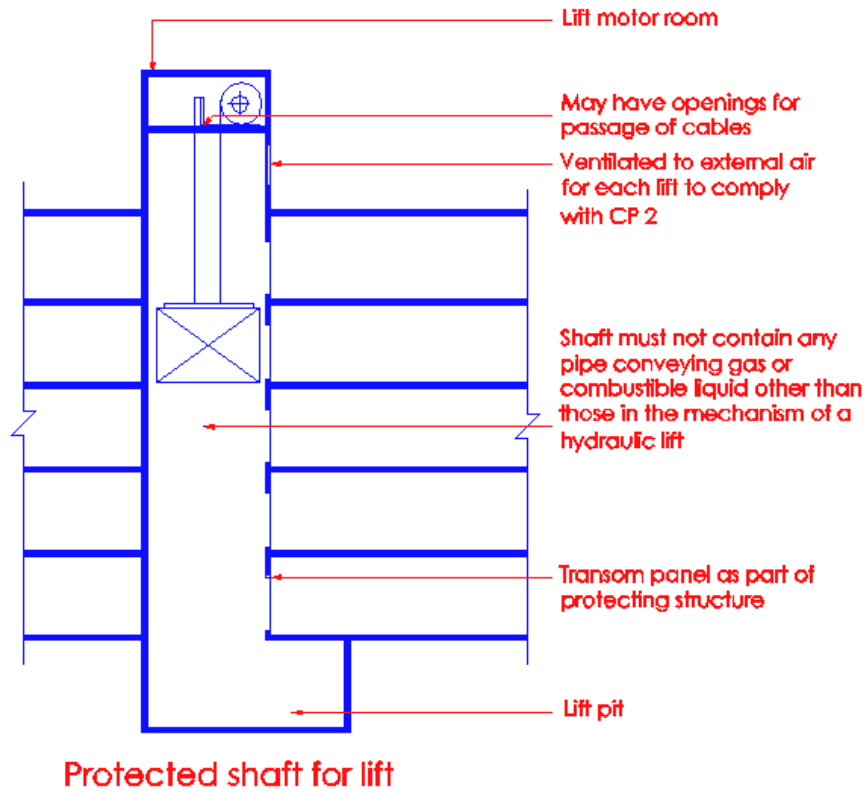

Diagram 3.8.8(a) & (b) - 1

Lift shaft, which is not located at the edge of atrium floors or at the external wall outside the building, shall be constructed of masonry.

Sub-clause (a) above specifically permits combustible liquid in the mechanism of hydraulic lift. The liquid is concealed in vessels and forms part of the mechanical system to permit the homing of the lift during an emergency. The liquid has a high flash point of over 400°C.

- 3.8.8 (c) Where a lift is either located at the edge of atrium floors or at the external wall and outside the building, the lift shall be considered as not enclosed within a protected shaft.

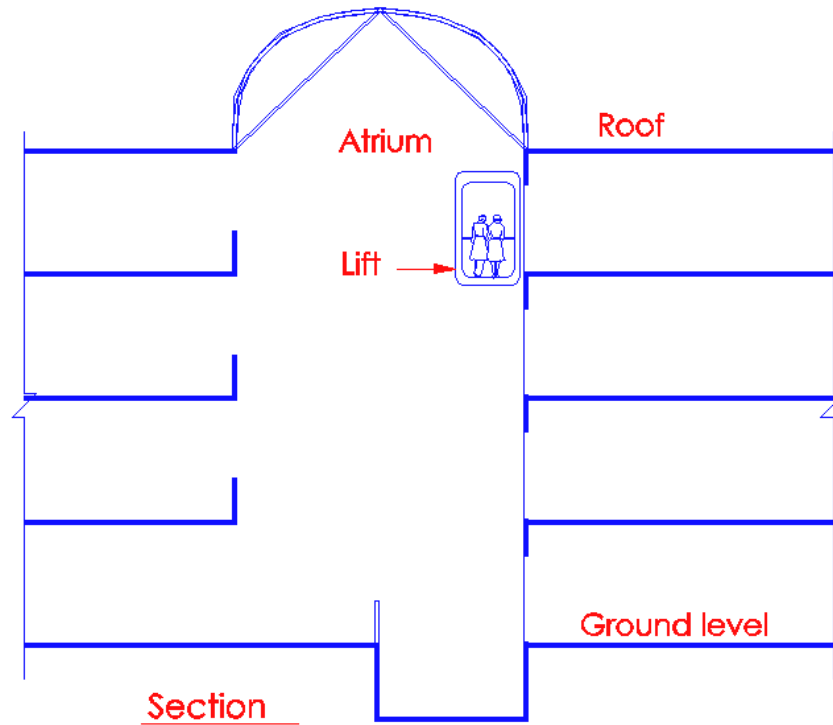

Diagram 3.8.8(c) - 1

*In the above diagram the lift is unenclosed, being located within the atrium void. There is no penetration of any compartment floor and smoke migration caused by the 'piston-effect' of lift movement is no longer a concern. Smoke from a fire in any occupancy floor will flow from the ceiling layer into the atrium void where it will tend to rise upwards due to its natural buoyancy. A smoke control system would eventually extract the smoke out of the building.*

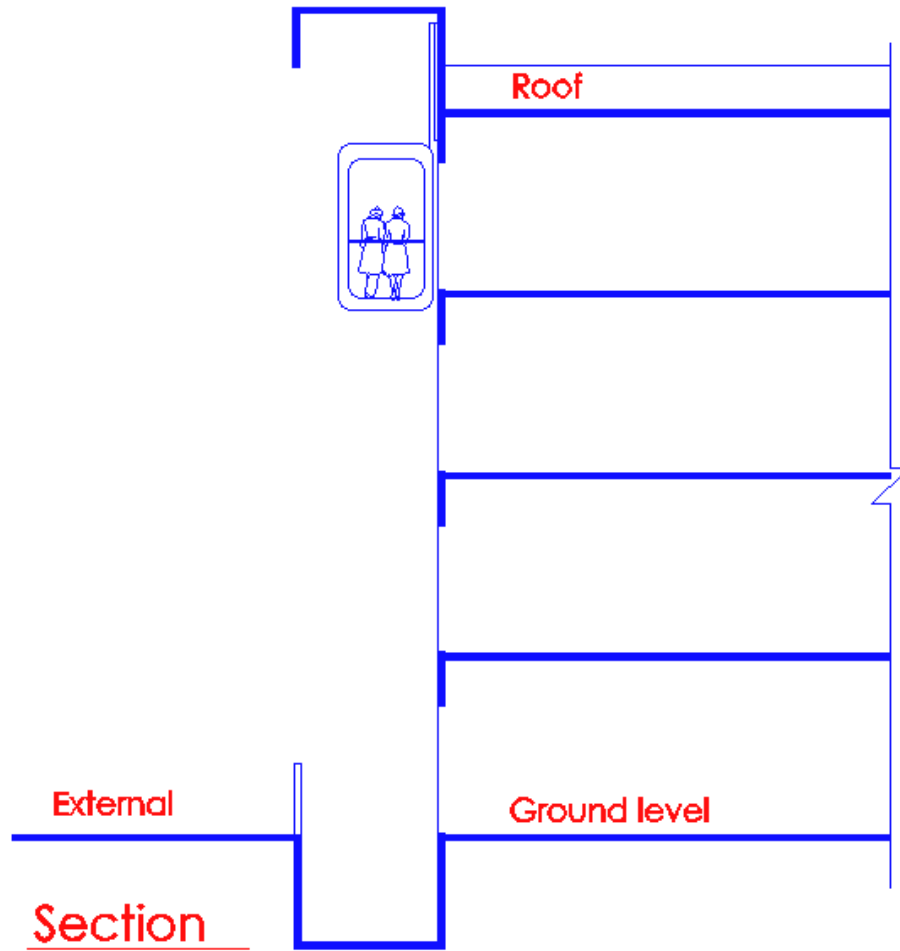

Diagram 3.8.8(c) - 2

*The lift is sited outside the external wall of the building. There is no concern of smoke and heat being transferred from floor to floor. Hence it is not required to be enclosed in a protected shaft. This type of lift is commonly known as 'bubble lift' or 'sky lift'.*

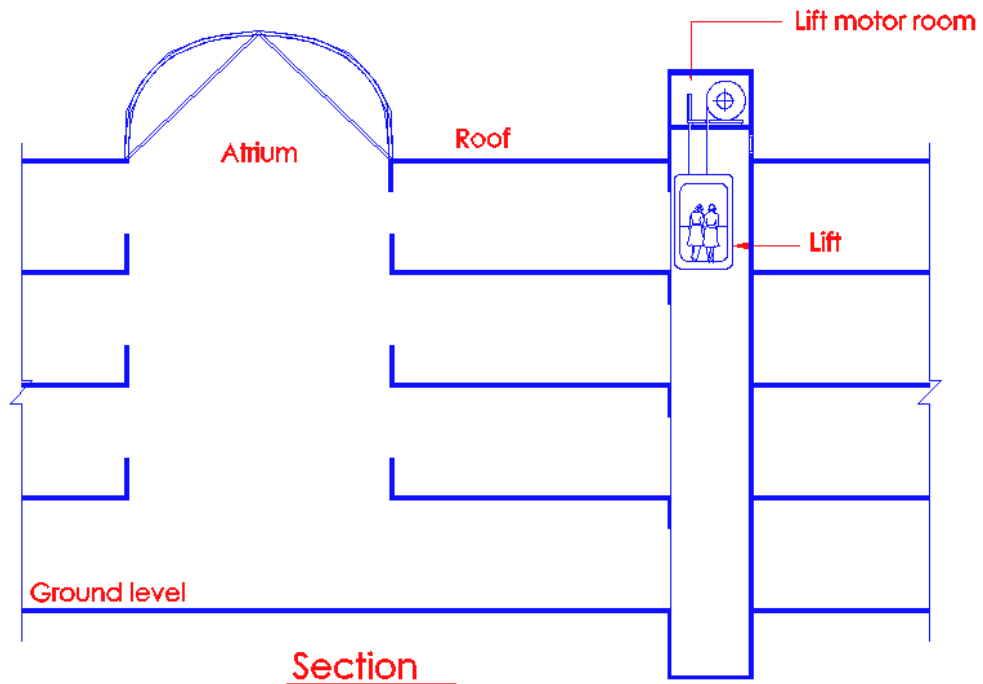

Diagram 3.8.8(c) -3

The above diagram shows that the lift is located away from the atrium void. As the lift punctures through the compartment floors, it must be enclosed in a protected shaft to prevent the spread of smoke and heat from floor to floor.

- 3.8.8 (d) The protected shaft shall be vented in accordance with SS CP 2 Code of Practice for Installation, Operation and Maintenance of Electric Passenger and Goods Lifts. The vents shall be so arranged as to induce exhaust ventilation of the shaft. Where vents could not be provided because of the location of the lift shaft, ventilation duct protected by drywall complying with Cl.3.8.8(b) serving as ventilation of the shaft may be provided instead. If the duct is not to be fire rated, fire dampers shall be provided to the duct at the wall of the lift shaft, provided such relaxation shall not apply to shaft containing fire lift.

- 3.8.8 e) Openings may be permitted for the passage of lift cables into the lift motor room and if the lift motor room is at the bottom of the shaft, the opening shall be as small as practicable.

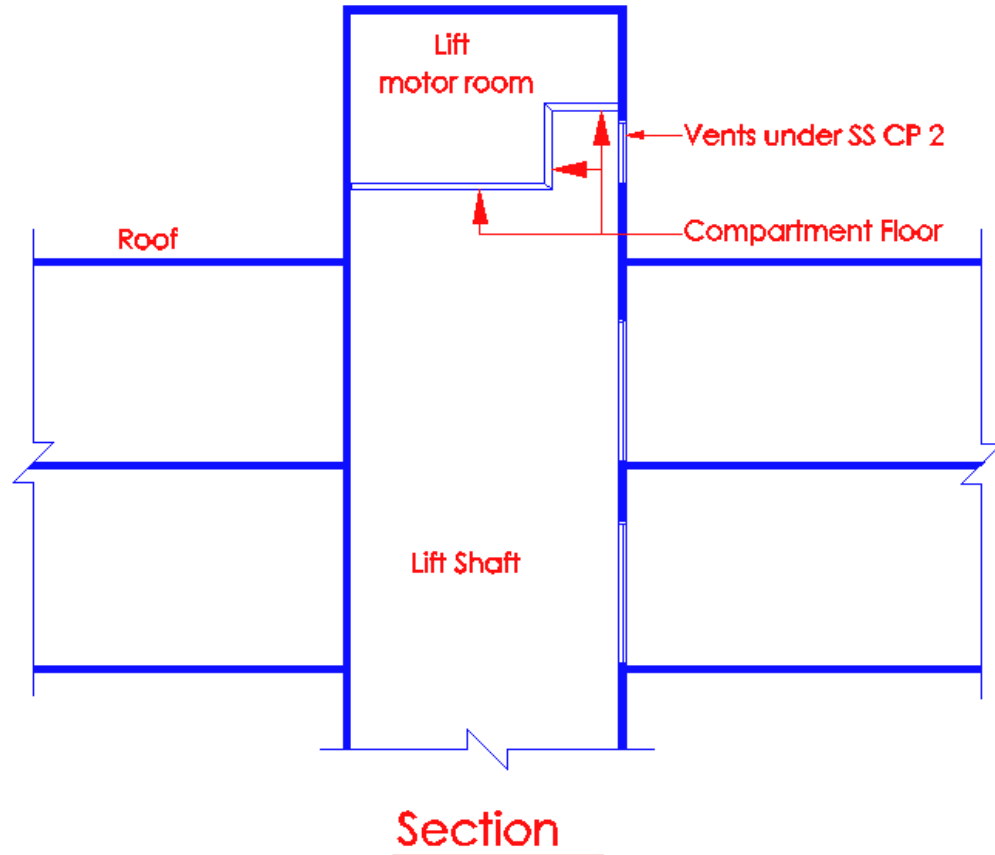

Diagram 3.8.8(e) - 1

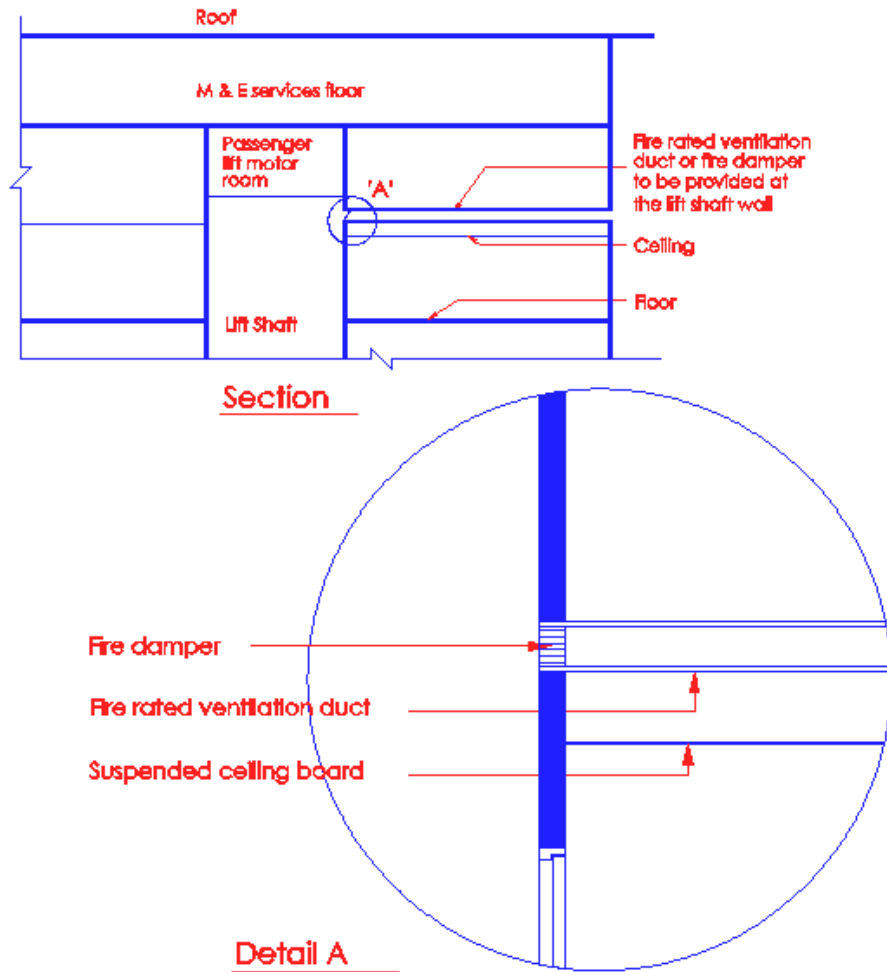

Diagram 3.8.8(e) – 2

All lift shafts shall be vented at the top in accordance with SS CP 2. In situations, where the lift shafts could not be brought above the roof as shown in diagram 3.8.8(d) – 2, horizontal fire rated duct could be used to provide air relief to the lift shaft. If the duct is not fire rated, appropriate fire damper could be provided in the wall of the protected lift shaft as shown 'A' in the above diagram. The above relaxation shall not be applicable to fire lift.

- (f) Transom panel above lift entrance shall be considered as part of the protecting structure and shall therefore conform to the fire resistance requirements of the protected structure.



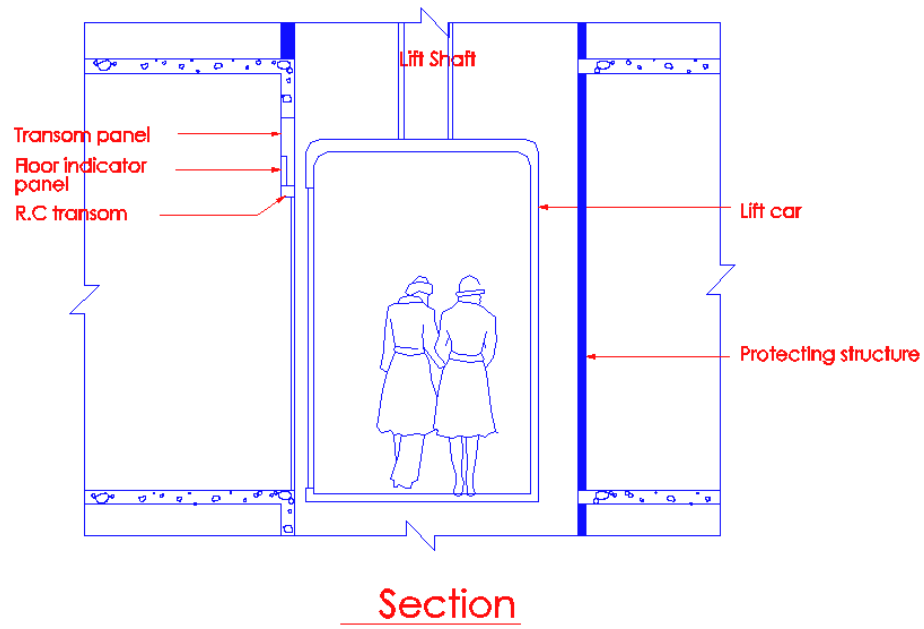

Diagram 3.8.8(f)

*Floor indicator panel should be surface mounted. If it is built into the transom panel, care should be taken to ensure that the fire resistance of the panel is not lowered. It is a common mistake to puncture the transom panel to receive the floor indicator panel without giving consideration to the fire integrity of the panel. Such practice contravenes the above requirement, as Cl.3.8.2 requires that the protecting structure, including the transom panel, forms a complete barrier and should have the appropriate fire resistance rating.*

- (g) If it serves any basement storey and not adjoining of any void connecting to upper levels or any external spaces, there shall be provided a lobby enclosed by walls having fire resistance of not less than 1 hour and fire door of not less than half an hour.

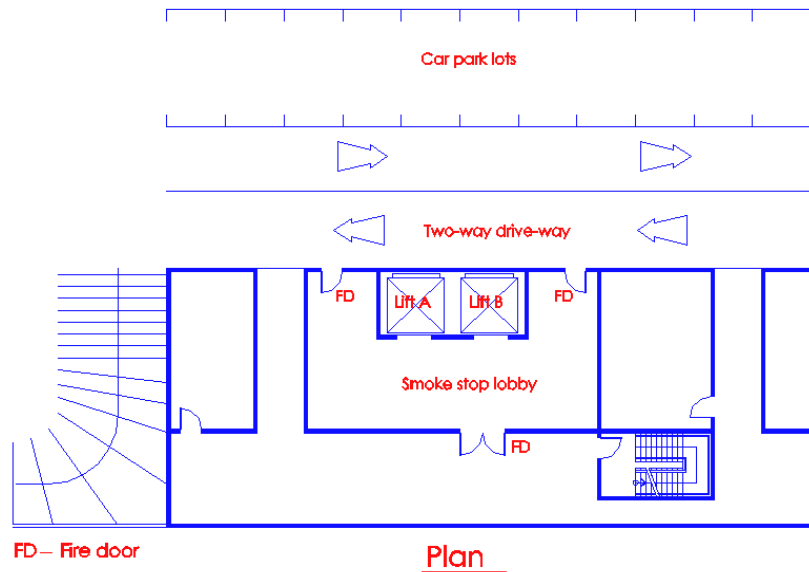

Diagram 3.8.8(g) - 1

Lift opening into basement and not adjoining a void that opens to the sky or any external spaces, shall be provided within a smoke stop lobby having 1-hour fire rated enclosures and ½-hour fire door.

The smoke-stop lobby acts as a buffer zone to prevent smoke from being drawn into the lift shaft through the 'piston-effect' of the movement of the lift.

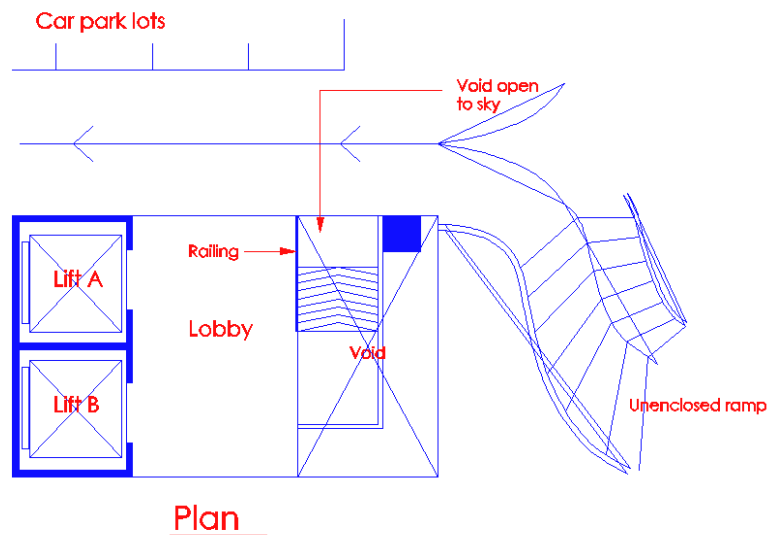

Diagram 3.8.8(g) - 2

In the above situation, the void opening to the sky would help to vent smoke out of the basement. Smoke occurring in the vicinity of the lift would be drawn into the void and vented upward into the open space. This provision would help to reduce the chance of smoke being pushed into the lift shaft. Hence, the provision of smoke stop lobby is not required.

3.8.9 A protected shaft used for the enclosure of services shall comply with the following:

(a) Protected shaft containing other services installations

The protecting structure for protected shaft containing kitchen exhaust ducts and mechanical ventilation ducts serving areas specified in Cl.5.2.1(g)(i) to (iii) and (h) which pass through one or more floor slabs shall be of masonry or drywall. Such shaft shall be completely compartmented from the rest of the shaft space containing other ducts or any other services installations. Protected shaft containing ducts serving other areas which pass through two or more floor slabs shall be constructed of drywall. If the protecting structure for the protected shaft is constructed of drywall, the following conditions shall be complied with :

- (i) Drywall shall be non-combustible; and
- (ii) Drywall shall have fire resistance for not less than the relevant period specified in Table 3.3A having regard to the purpose group of the building of which it forms a part and the dimension specified in that Table; and
- (iii) Drywall shall meet the criteria, in terms of impact and deflection performance, when subject to the tests of BS 5588 Pt 5 Appendix A and BS 5234 Pt 2; and
- (iv) Drywall shall meet the criteria, in terms of water absorption and bending strength; and performance, when subject to the test of BS 1230 Pt 1 (for gypsum plaster board) or ISO 1896 (for calcium silicate or cement board).

*The protecting structure for protected shaft containing kitchen exhaust duct and mechanical ventilation ducts which pass through one or more floors and serving areas such as:*

- (i) exit staircases and exit passageways*
- (ii) smoke-stop and fire fighting lobby*
- (iii) areas of refuge within the same building*
- (iv) emergency generator*
- (v) engine driven fire pump*

*shall be constructed in masonry. Each shaft shall be separately compartmented from one another. Shaft passing through one floor refer to passing through any floor slabs.*

Protected shaft containing ducts serving other areas not mentioned above and which pass through two or more floors can be constructed of fire rated materials, instead of masonry.

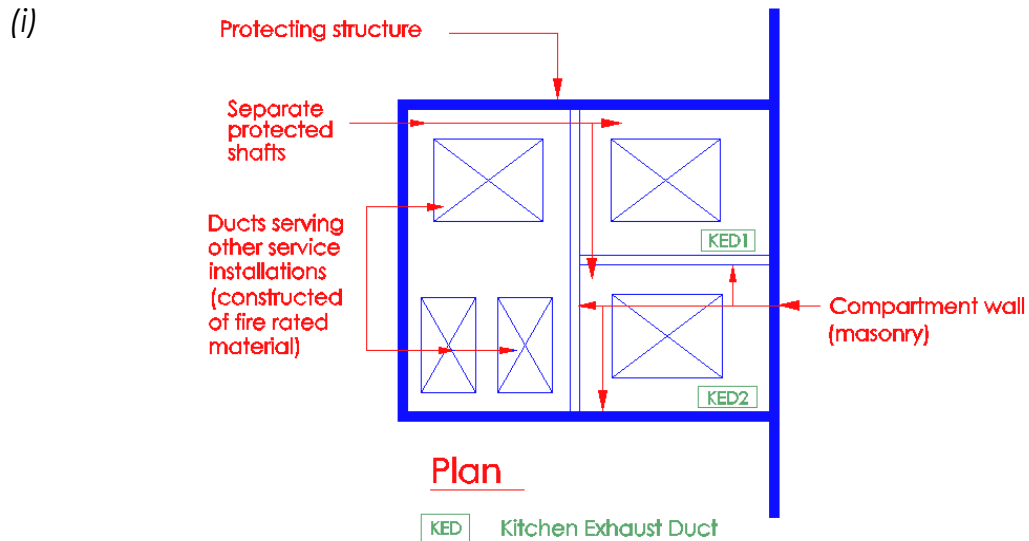

Diagram 3.8.9(a) - 1

Kitchen exhaust duct shall be in a separate compartment from that for a mechanical ventilation duct. Kitchen exhaust ducts serving different kitchens shall be in separate shafts. Mechanical ventilation duct serving the area of refuge shall be in different shaft from that serving the pump room. The main reason for separate shafts is to prevent smoke and fire spread from shaft to shaft.

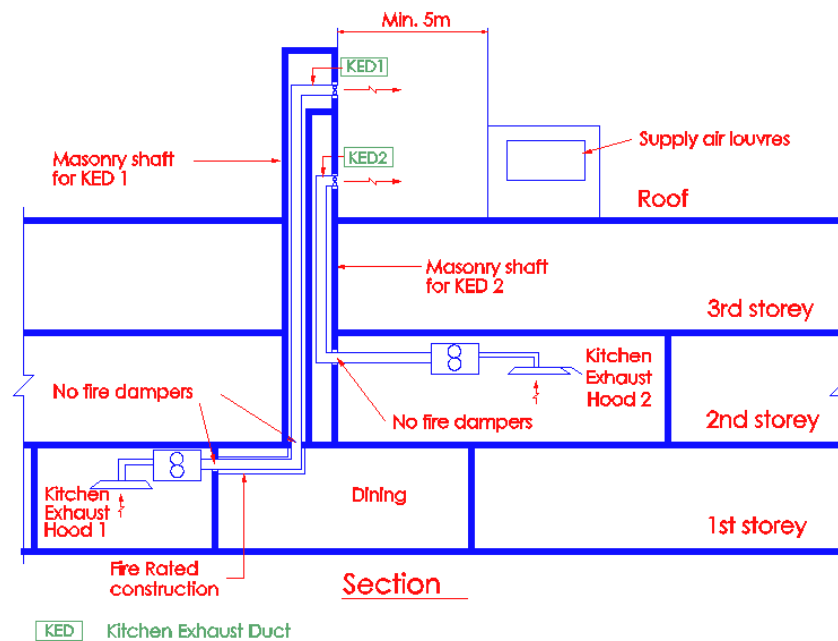

Diagram 3.8.9 – 2

- (a) In the above diagram (see kitchen 2), although the flue or duct passes through the 2<sup>nd</sup> storey floor slab only, it is required to be encased in masonry.
- (b) When the flue or duct passes through one or more floors (any floor), it shall be encased in masonry material to ensure stability and prevent mechanical damage. (See Kitchen 1)

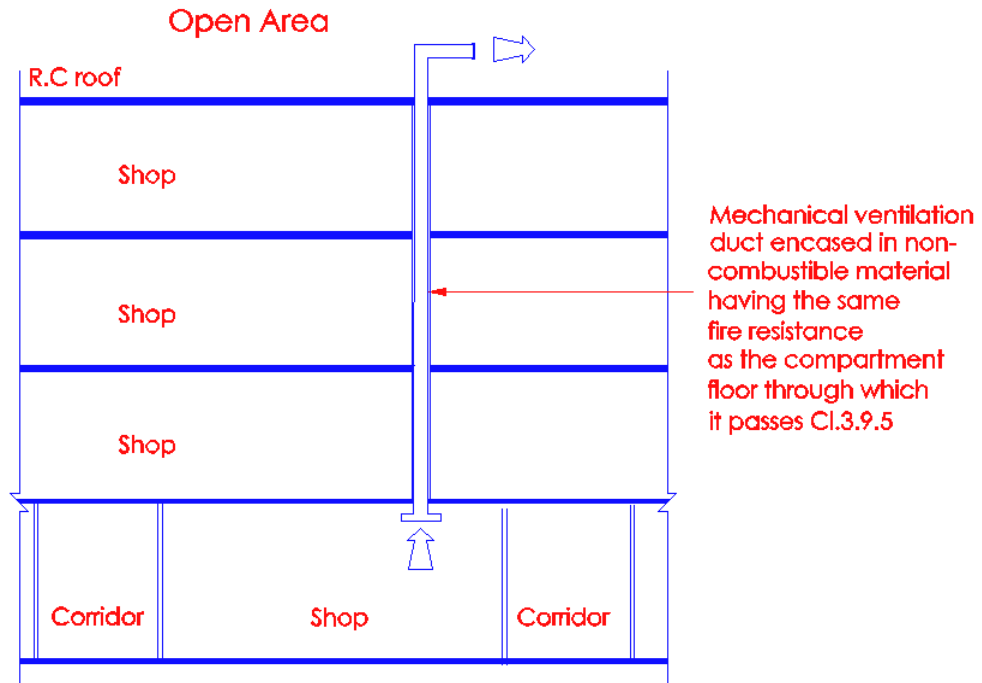

Diagram 3.8.9 – 3

Protected shaft containing ducts serving other areas, excluding (i) exit staircases and exit passageways; (ii) smoke stop and fire fighting lobby; (iii) areas of refuge within the same building; (iv) emergency generator; (v) engine driven fire pump, and pass through 2 or more floors can be constructed of fire rated materials, instead of masonry.

(ii)

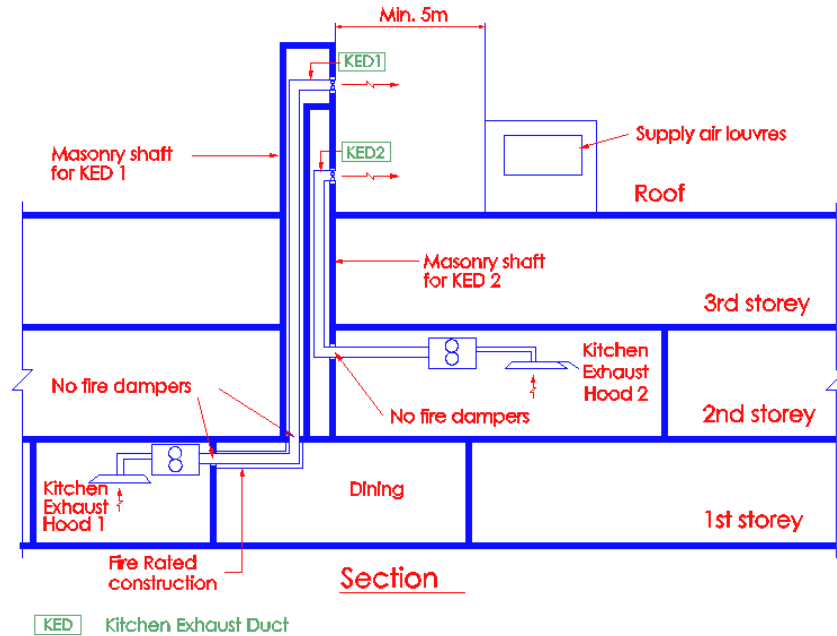
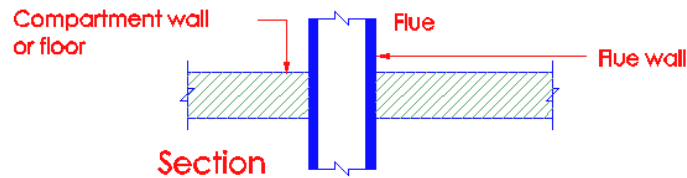

Diagram 3.8.9(a) - 4

Kitchen exhaust shaft for each kitchen is completely separated. The horizontal run of the exhaust from kitchen 1 is protected with fire rated material.

(iii)

**a. Flue passing through compartment wall or floor**



Flue walls should have a fire resistance of at least one half of that required for the compartment wall or floor, and be of non-combustible construction

**b. Flue built into compartment wall**

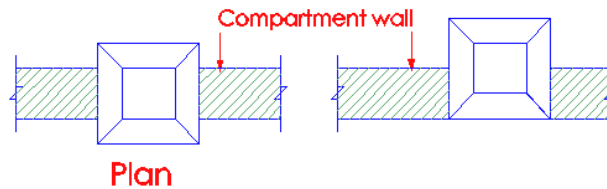

In each case flue walls should have a fire resistance of at least one half of that required for the compartment wall and be of non-combustible construction

Diagram 3.8.9(a) - 5

If a flue, or duct containing flues or appliance ventilation duct(s), passes through a compartment wall or compartment floor, or is built into a compartment wall, each wall of the flue or duct shall have a fire resistance of at least half that of the wall or floor in order to prevent the by-passing of the compartmentation.

- 3.8.9 (b) Protected shaft used for the enclosure of electrical power services shall be interrupted at every floor level with barriers with fire resistance of at least half an hour. Protected shaft used for the enclosure of telecommunications cables shall be interrupted by barriers with fire resistance of at least half an hour at vertical intervals not exceeding 15m. Such cavity barriers shall comply with the relevant provision of Cl.3.11.
- (i) Protected shaft containing electrical power services

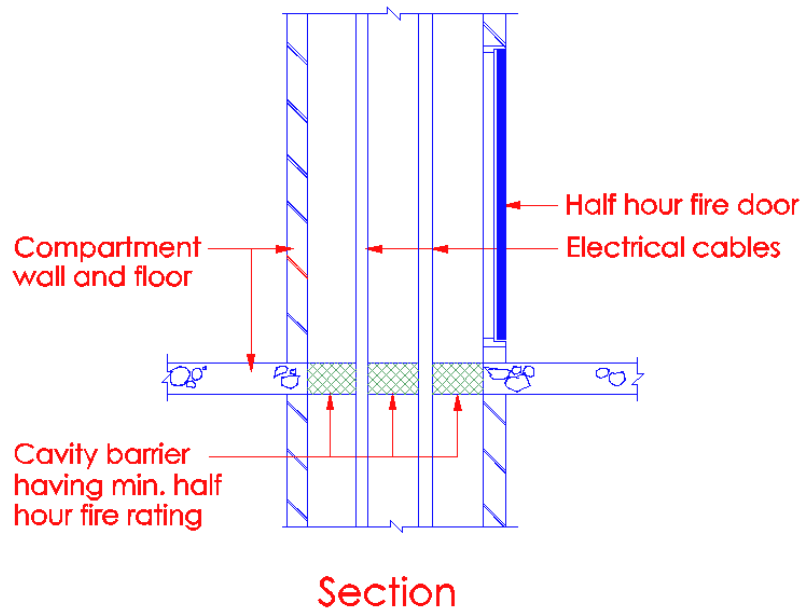

Diagram 3.8.9(b) – (i)

Protected shaft containing electrical cables shall be interrupted at every floor with cavity barrier having min. ½-hour fire rating to prevent vertical spread of fire and smoke. The main concern is that cables are a possible source of both fuel and ignition. The presence of fire stopping at every floor would help to confine fire to a single storey or segment of the shaft.

- (ii) Protected shaft containing Telecom cables, including Network Cables for computers.

Protected shaft used for the enclosure of telecommunications cables shall be interrupted by barriers with fire resistance of at least half an hour at vertical intervals not exceeding 15m. Such cavity barriers shall comply with the relevant provisions of Cl. 3.11.

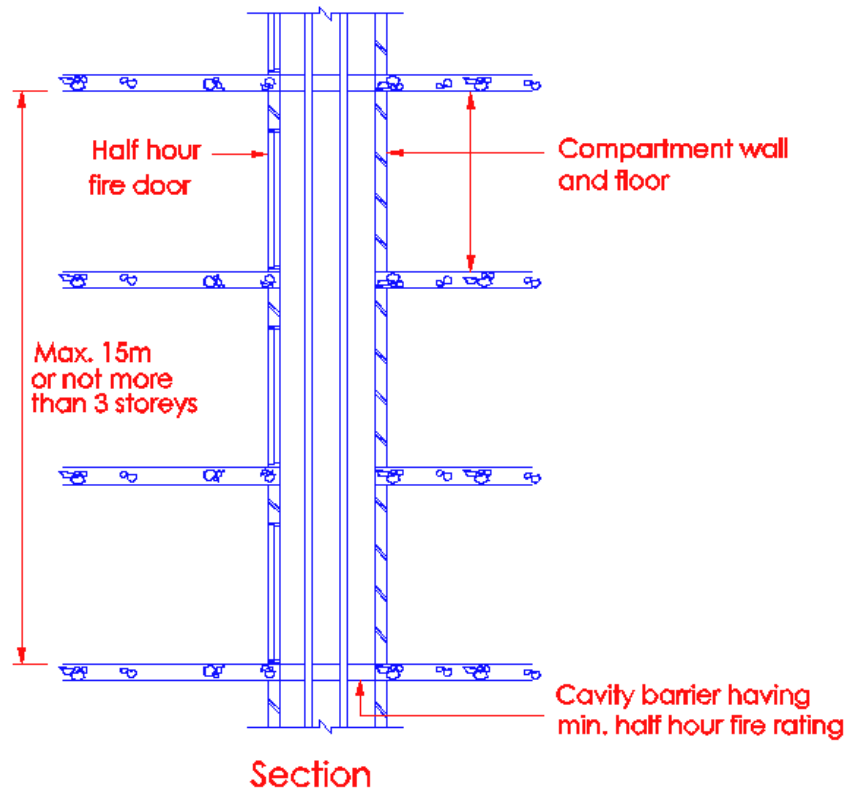

Diagram 3.8.9(b) – (ii)

Protected shaft containing telecommunications cables including network cable for computers (LAN) & cable TV lines is provided with cavity barrier at vertical intervals not exceeding 15m or 3 storeys whichever is the shorter. The cables are mainly of low voltage and hence of a lower risk when compared to electrical cables.

(c) Omission of self-closing device

In the case of protected shafts which are interrupted by barriers with fire resistance of at least half an hour at every floor level, fire resisting doors opening into the protected shaft may not be required to be installed with automatic self-closing devices, provided such doors are kept closed and locked at all times.



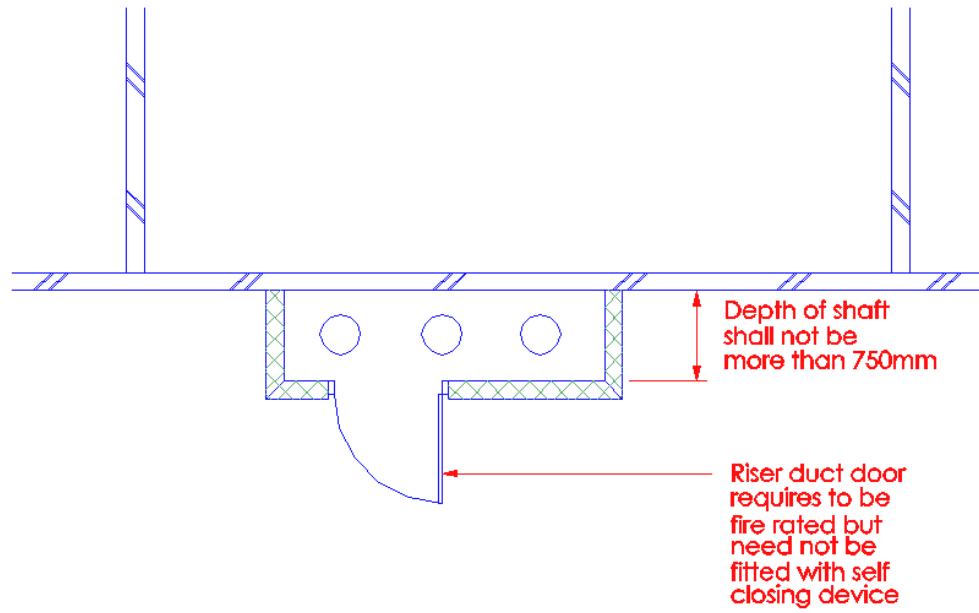

Diagram 3.8.9(c)

Provision of self-closing device for the inspection door of a protected shaft, which is interrupted by barriers having at least  $\frac{1}{2}$ -hour fire resistance at every floor, is not required. The above relaxation is also applicable to TAS shafts, provided they are interrupted by barriers with fire resistance of at least  $\frac{1}{2}$ -hour at every floor level.

An important point to note is the depth of the shaft which shall not exceed 750mm. If it exceeds 750mm, the shaft would be considered as a room and provision of self-closing device for the fire door becomes a necessity.

The above relaxation is based on the understanding that it is unlikely that a shaft would be converted to a store if its depth is less than 750mm and that the door would normally be kept in locked position when workmen are not carrying out servicing work. Also, maintaining the door in locked position is the responsibility of the management corporation of the estate.

3.8.9 (d) All protected shafts containing services shall not be located within an exit staircase.

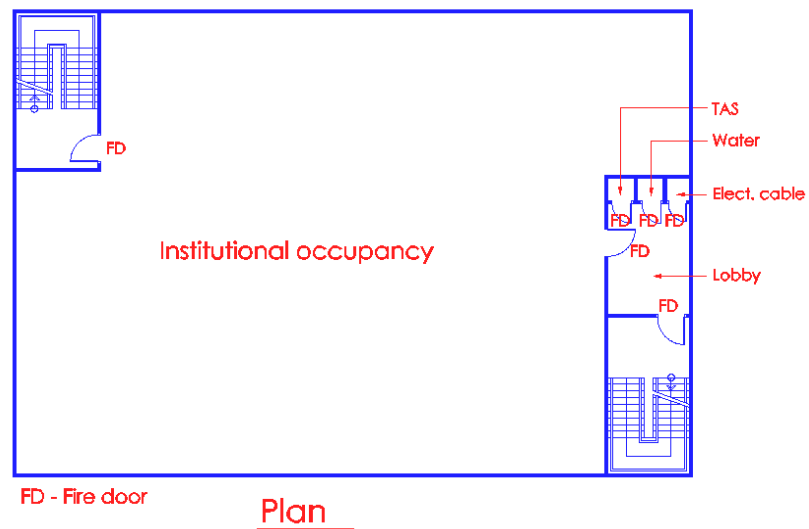

Diagram 3.8.9(d) - 1

All storeys of an institutional building, which does not require the provision of smoke stop lobby to exit staircase by virtue of its height, shall be required to comply fully with the above requirement. All protected shafts containing services are to be located in a common lobby adjoining the exit staircase.

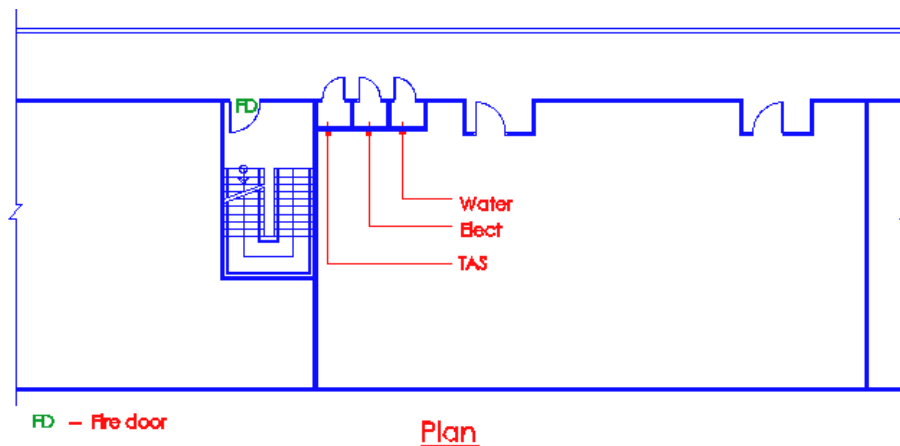

Diagram 3.8.9(d) - 2

Although the services are enclosed in protected shafts, they are not permitted to be located in exit staircase. The main reasons are :

Within the protected shaft, the combustible materials eg. Cables PVC pipes are a source of fire risk. A fire could originate from these combustible materials and spread in the exit staircase enclosure.

Exit staircase is a dedicated route for escape of occupants, services which are not serving the staircase shall not be located inside the enclosure.

### 3.9 PROTECTION OF OPENINGS

#### 3.9.1 Application

The provisions of this Clause are made in connection with the protection of openings permitted in elements of structure or other forms of fire resisting construction required to act as a barrier to fire and smoke.

*(No illustration)*

*For functional purposes, openings in compartment walls, floor etc are required in buildings to allow movement of people and the installation of services such as pipes, ventilation ducts etc. To prevent the spread of fire and smoke, such openings shall be appropriately protected.*

#### 3.9.2 Fire doors

Fire doors for protection of openings shall comply with the following:

- (a) Fire doors shall have the appropriate fire resistance as required by relevant parts of the Code, and two fire resisting doors may be fitted in an opening if each door by itself is capable of closing the opening and the two doors together achieve the required level of fire resistance, and

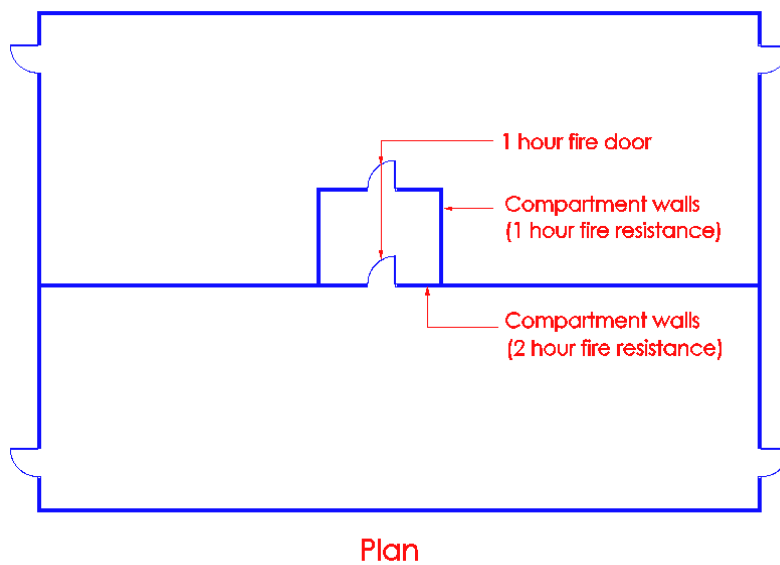

Diagram 3.9.2(a) - 1

*The two 1-hour fire door arrangement is deemed to be equivalent to permitting one fire door of 2-hour fire resistance rating in the compartment wall (2 hours).*

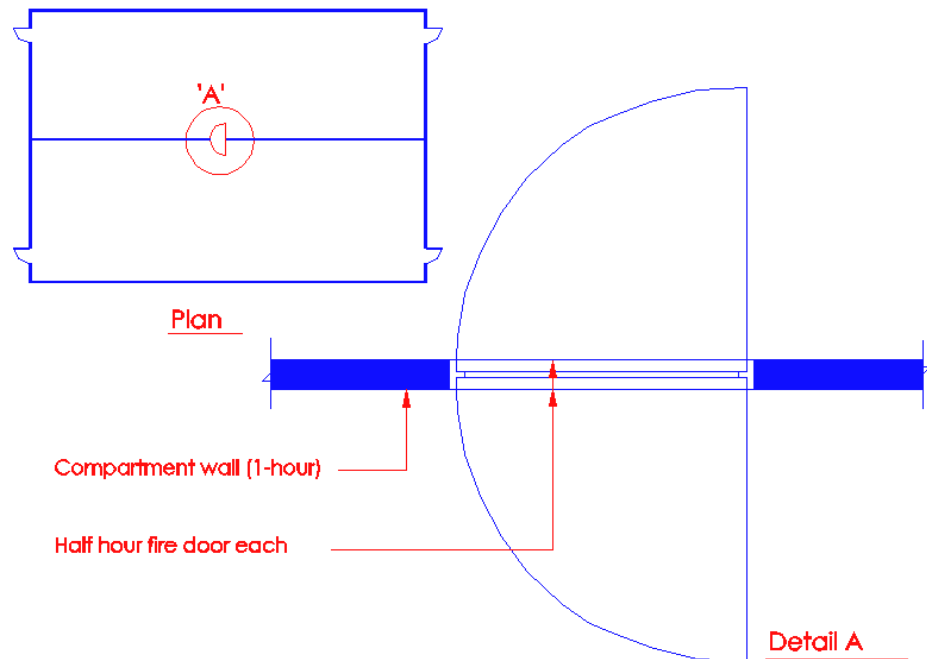

Diagram 3.9.2(a) - 2

The provision of fire doors shown in the above diagram usually occur in separating walls, compartments e.g. dormitories, hostel bedrooms or protecting structures. The 2 doors shall be independent of each other and having its own door frame. However, the 2 doors may share the same door frame only if that set of door is tested to achieve the required rating. This arrangement shall not form part of the escape exit route.

- (b) All fire doors shall be fitted with an automatic self-closing device which is capable of closing the door from any angle and against any latch fitted to the door, and

(No illustration)

All fire doors are required to be fitted with an automatic self-closing device, which shall not include rising butt. Self-closing device is not required to be fitted to doors of protected shafts having a depth of not more than 750mm under sub-clause 3.8.9(c).

Fire resisting door to exit openings, protected staircases, protected lobbies, exit passageway, compartment walls etc. shall have minimum half-hour fire resistance. Doors to exit facilities shall not be fitted with any locking device. However, doors to exit openings would be fitted with locking devices for security reasons. As fire door is to protect the openings in exit facilities, it should always remain in the closed position to prevent the spread of smoke and heat.

The main function of the self-closing device is to return the door to its closed position after being opened for movement of occupants, goods etc. The passage latch fitted to the door is to hold the fire door in closed position to counteract the pressure differential across the door opening in a fire situation.

Buildings may have card key access or automatic locking devices fitted to doors of exit staircases to prevent unauthorised access by outsiders.

To gain entry into the staircase or to exit from it into any floor, the occupants need to key in a code number or use a card key access to unlock or release the locking device to the door. In times of power failure or activation of fire alarm system, the locking device would be unlocked automatically and all the exit doors could be opened manually. Prior approval should be obtained from SCDF (FSSD) before any door to exit facilities is fitted with any form of locking device.

When the door to the exit facilities consists of double leaves or multiple leaves, all the leaves shall be fitted with self-closing device and sequential closer or also known as door selector.

Self-closing device to fire door shall be properly maintained regularly. Faulty device shall be repaired immediately to prevent fire door being left in the open position.

- (c) Where a self-closing device would be considered a hindrance to the normal use of the building, fire resisting doors may be held open as follows :
- (i) by a fusible link, or
  - (ii) if the doors can be opened manually, by electromagnetic or electro-mechanical devices which can be activated by the presence of smoke and/or the building alarm system,

*(See illustration in Cl.1.2.20 under Definition in Volume 1)*

- (d) Any hinge on which a fire door is hung shall be made entirely of non-combustible materials having a melting point of at least 800° C , and

*(No illustration)*

- 3.9.2 (e) Any fire door fitted in an opening which is provided as a means of escape:
- (i) shall be capable of being opened manually, without the use of key, tool, special knowledge or effort for operation from the inside of the building; and
  - (ii) shall not be held open by any means other than by an electromagnetic or electro-mechanical device which can be activated by the presence of smoke and/or the building alarm system, provided that this shall not apply in the case of fire doors opening into pressurised exit staircases.
  - (iii) shall open in the direction of exit travel in accordance with Cl. 2.3.9.

*(See illustration in Cl.1.2.20 under Definition in Volume 1)*

- (f) Fire doors where required to be provided shall be constructed and installed to comply with specifications stipulated under SS 332 Specification for Fire Doors.

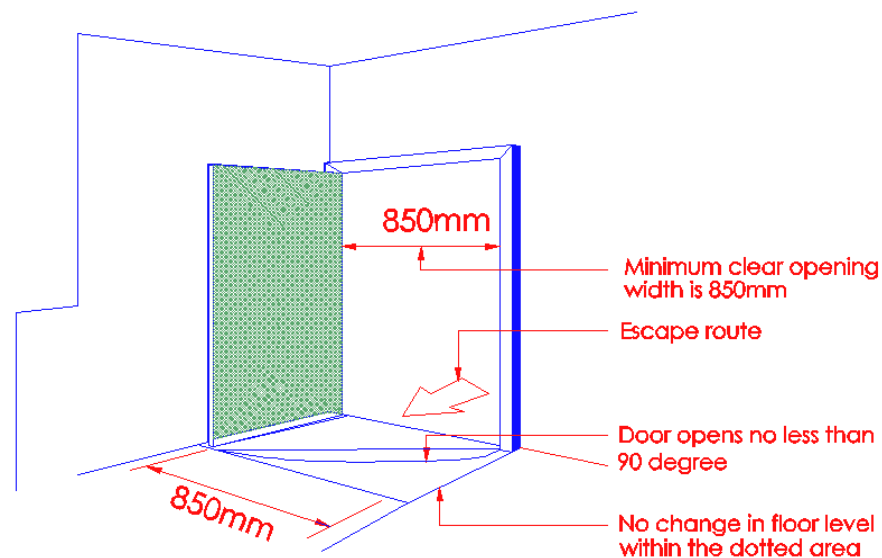

Diagram 3.9.2(f)

*All fire doors should be of approved type under the PSB, Product Listing Scheme of Productivity and bear PSB label or mark. It is important to note that fire door opening into pressurised exit staircases shall not be fitted with electromagnetic or electro-mechanical device. This is to ensure that the integrity of the pressurised exit staircase is maintained at all times.*

### 3.9.3 Pipes

Pipes which pass through a separating wall, compartment wall or compartment floor shall be kept as small as possible and fire-stopped around the pipe. The nominal internal diameter of the pipe shall be not more than the relevant dimension given in Table 3.9A. Spacing between pipes shall be minimum 50mm or  $\frac{1}{2}$ -diameter of the largest pipe, whichever is the larger.

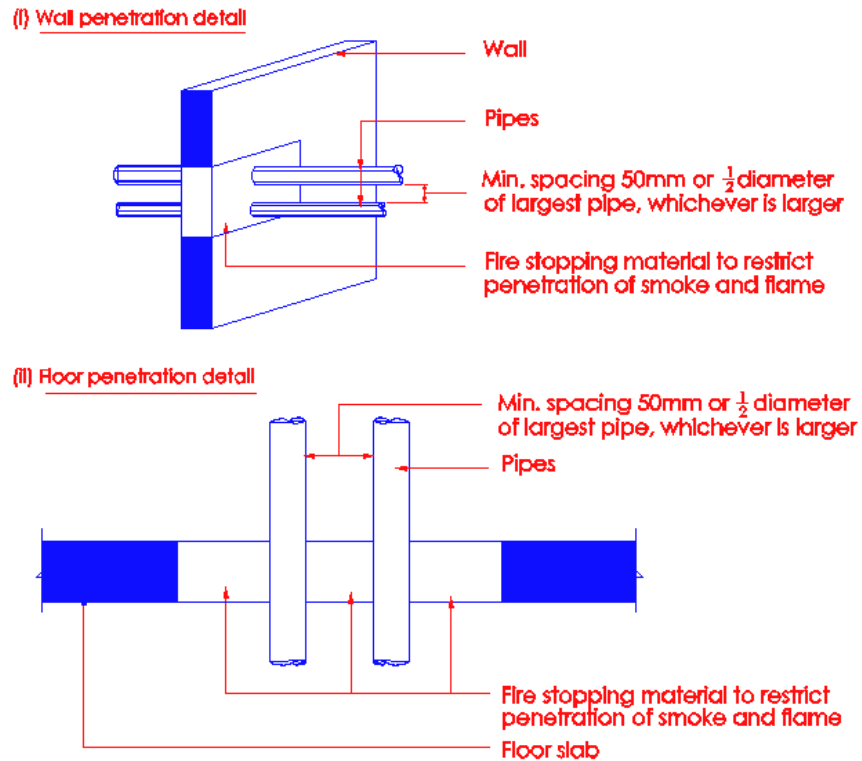

Diagram 3.9.3 - 1

*The clustering of pipes without proper spacing would further weaken the integrity of the fire resisting walls in times of fire emergency.*

## Penetration of elements of structure by pipes

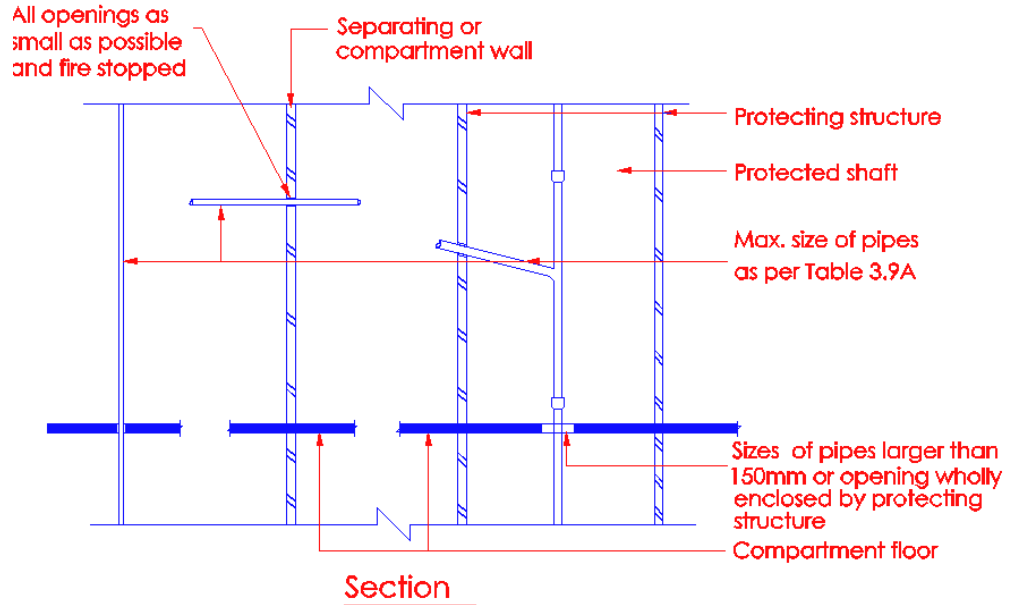

Diagram 3.9.3 - 2

## UPVC pipes located in external corridor

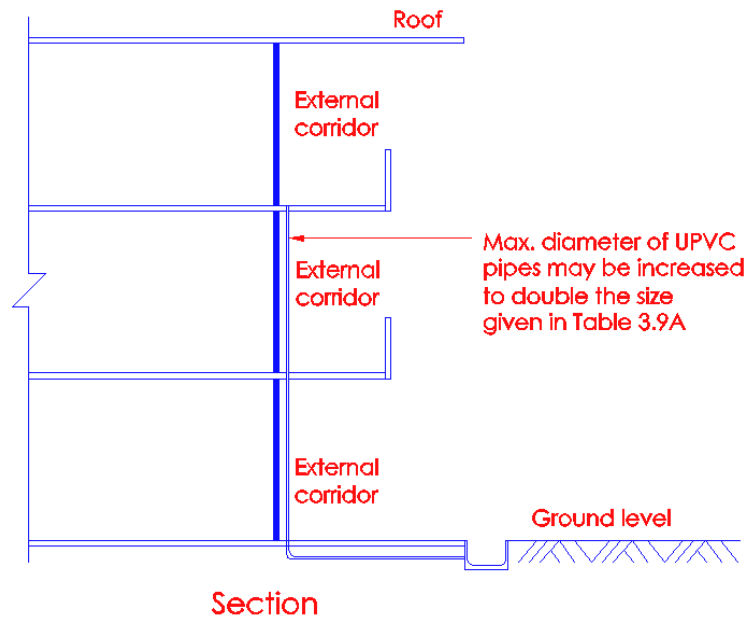

Diagram 3.9.3 - 3

External corridor would be well ventilated. Hence lower fire risk and the threat of spread of fire and smoke from floor to floor is very much reduced.



Table 3.9A

TABLE 3.9A MAXIMUM NOMINAL INTERNAL DIAMETER OF PIPES

Situation	Pipe material and maximum nominal internal diameter [mm]		
	Non-combustible material <sup>1</sup>	Lead, aluminium or aluminium alloy, or UPVC <sup>2</sup>	Any other material
When the pipes penetrate the structure enclosing a protected shaft which is not an exit stairway or lift shaft	150	100	40
Any other situation	150	100 (stack pipe) <sup>3</sup> 75 (branch pipe) 3	40

Notes

- 1) *A non-combustible material (such as cast iron or steel) which if exposed to a temperature of 800 degrees Celsius will not soften nor fracture to the extent that flame or gases will pass through the wall of the pipe.*
  - 2) *UPVC pipes complying with SS 141 or SS 213.*
  - 3)
    - i) *Within toilets, wash rooms or external corridors, maximum diameter of UPVC pipes may be increased to double the size given in the above table.*
    - ii) *Within areas of fire risk, such as kitchens, and adjacent to escape routes, UPVC pipes shall be enclosed by construction having fire resistance of at least one half hour.*
    - iii) *Where the size of UPVC pipes exceeds that specified under this Clause, approved fire collar shall be fitted at all positions where such pipes pass through constructions required to act as a barrier to fire.*
- *“Any other situation” refers to separating wall, compartment wall/floor and other similar construction.*

Table 3.9A lists three specifications, which control the max. internal diameter of the pipes which penetrate elements of structure as follows:

a) 150mm diameter pipes of non-combustible material	Pipes which will not soften or crack sufficiently to permit passage of hot gases or flames when exposed to temperatures up to 800°C. If the pipe size exceeds 150mm, it shall be located within a protected duct or shaft
b) 100mm diameter (stack) and 75mm diameter (branch) pipes	Pipes of lead, aluminium or alloy and UPVC (complying to SS 141 or SS213) which would soften or crack sufficiently to permit passage of hot gases or flames when exposed to temperature below 800°C. Pipes of lead, aluminium or alloy exceeding 100mm diameter (stack) and 75mm diameter (branch) shall be located within a protected shaft or duct. UPVC pipes located in areas of fire risk such as kitchens or adjacent to escape routes shall be enclosed in protecting structure having min. 1 hour fire resistance rating or following that of the elements of structure, whichever is greater.  UPVC pipes located in other areas exceeding the sizes of 100mm (stack) or 75mm (branch) shall be fire stopped by approved fire collar at penetration of elements of structure.  Exception: Internal diameter of UPVC pipes located within toilets, wash rooms which are considered as "wet area" and in external corridor may be double that given in Table 3.9A
c) 40mm diameter pipe	Pipes of any other material shall not exceed 40mm unless located in protected duct or shaft

#### 3.9.4 Ventilation ducts

Ventilation duct which passes directly through a compartment wall or compartment floor shall comply with the following-

- (a) Where the ventilation duct does not form a protected shaft or is not contained within a protecting structure,
  - (i) the duct shall be fitted with a fire damper where it passes through the compartment wall or compartment floor, and

- (ii) the opening for the duct shall be kept as small as practicable and any gap around the fire damper shall be fire-stopped.

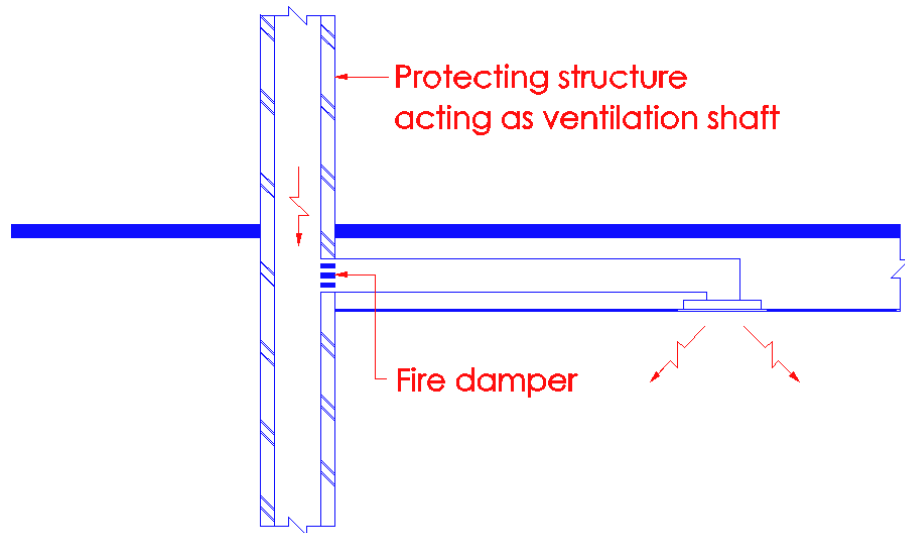

Diagram 3.9.4(a)

*Proper fire stopping around the duct where it penetrates the compartment floor/wall and provision of fire damper at the compartment wall/floor would help to prevent fire and smoke spread from compartment to compartment.*

- (b) Where the ventilation duct forms a protected shaft or is contained within a protecting structure, the duct shall be-
  - (i) fitted with fire dampers at the inlets to the shaft and outlets from it, and
  - (ii) constructed and lined with materials in accordance with requirements in Chapter 7.

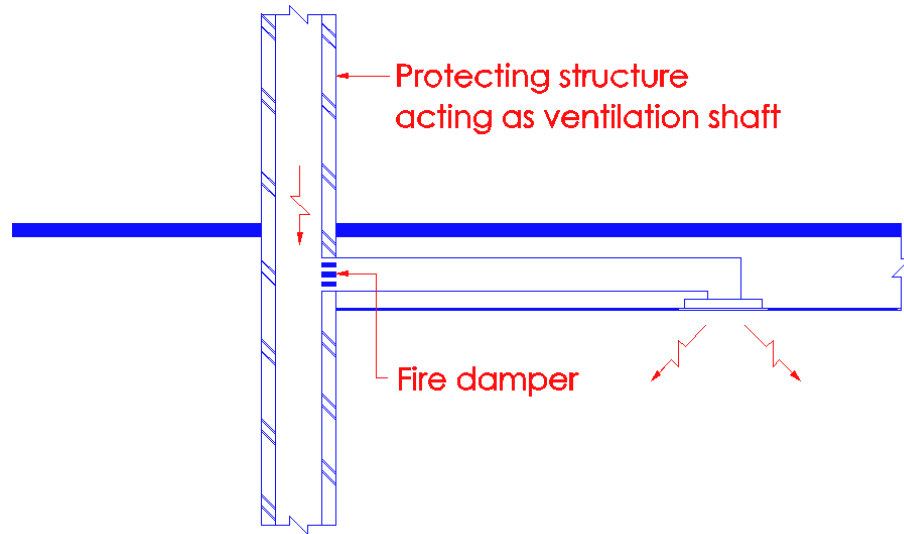

Diagram 3.9.4(b)

*The provision of fire damper at the entry to the protected shaft would help to complete the compartmentation to prevent fire or smoke from being drawn into the protected shaft via ventilation duct.*

- (c) The installation of ventilation ducts and fire dampers shall comply with the requirements in Chapter 7.

### 3.9.5 Flues

Duct encasing one or more flue pipes which passes through a compartment wall or compartment floor shall be of non-combustible construction having fire resistance of not less than half the minimum period of fire resistance required for the compartment wall or compartment floor through which it passes, except for kitchen flue pipes when the fire resistance shall be as required for the compartment wall or compartment floor.

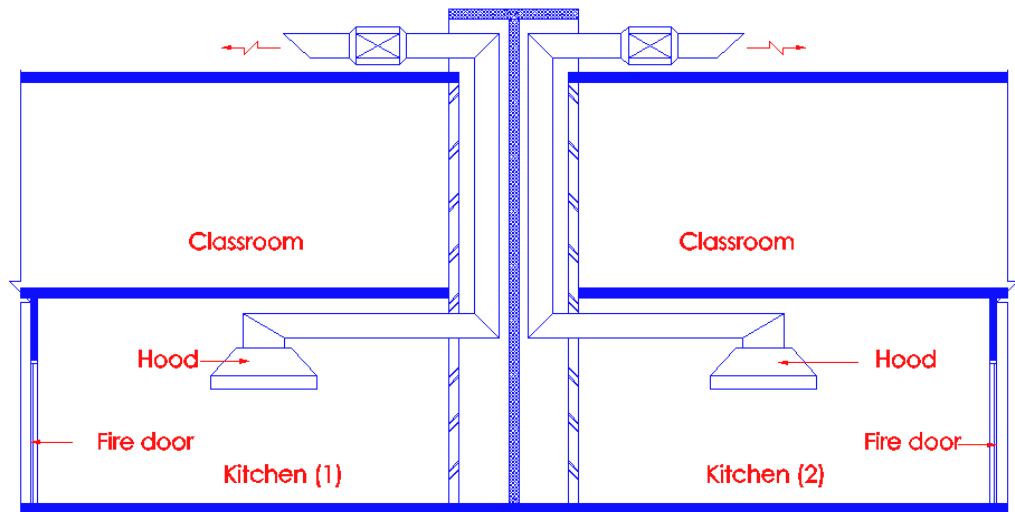
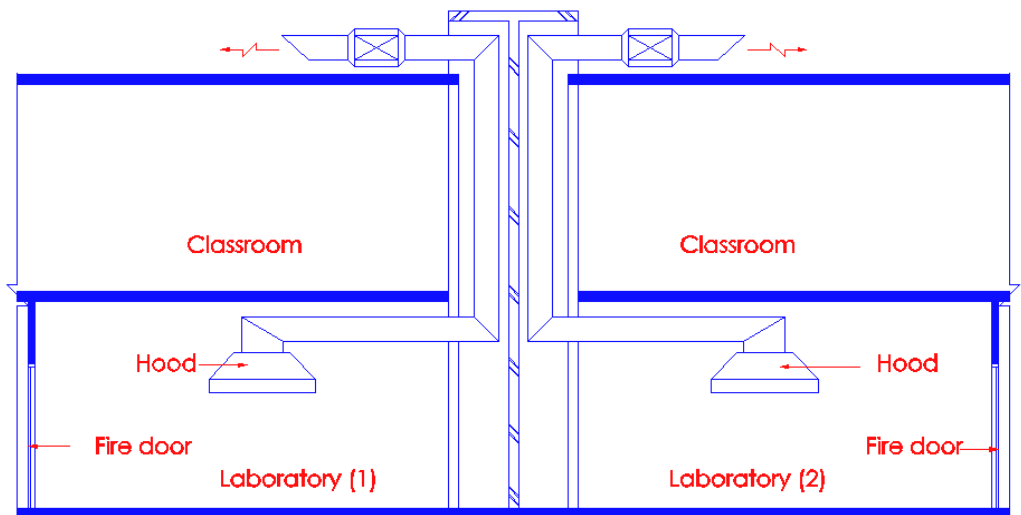

Diagram 3.9.5 - 1

Separate kitchen exhaust shaft enclosed in masonry construction shall be provided for Kitchen (1) and (2). This is to prevent the spreading of fire and smoke from one compartment to another. The wall enclosing the shaft shall have the same fire resistance as the compartment wall or floor.



Drawing 3.9.5 - 2

The enclosing walls to the duct serving the laboratory are required to be constructed of non-combustible materials, instead of masonry, and need to have not less than  $\frac{1}{2}$  the minimum period of fire resistance rating of the compartment walls or floor through which the duct passes.

### 3.9.6 Service pipings and ductings

Air ducts, sanitary pipings, gas and other services that are likely to permit the passage of flame or smoke in the event of a fire shall not be permitted to pass through rooms housing fire pump, emergency generator or fans handling smoke control system except where such services are required for the operation of these equipment.

(No illustration)

## **3.10 EXIT STAIRCASES**

### 3.10.1 Non- combustibility of structure

Every exit staircase, including the treads/risers and landing, shall be constructed of non-combustible materials.

*(No illustration)*

### 3.10.2 Structure separating exit staircase

The exit staircase shall be separated from other parts of the building by a masonry structure or drywall complying with Cl.3.8.7(c) which shall have fire resistance for not less than the period required by Cl.3.3 for Elements of Structure.

### 3.10.3 Exit Doors

Doors opening into the exit staircase shall have fire resistance of at least half an hour and fitted with automatic self-closing device.

### 3.10.4 Finishes to the ceiling/walls and floors of exit staircase shall be of non-combustible materials.

### Internal exit staircase

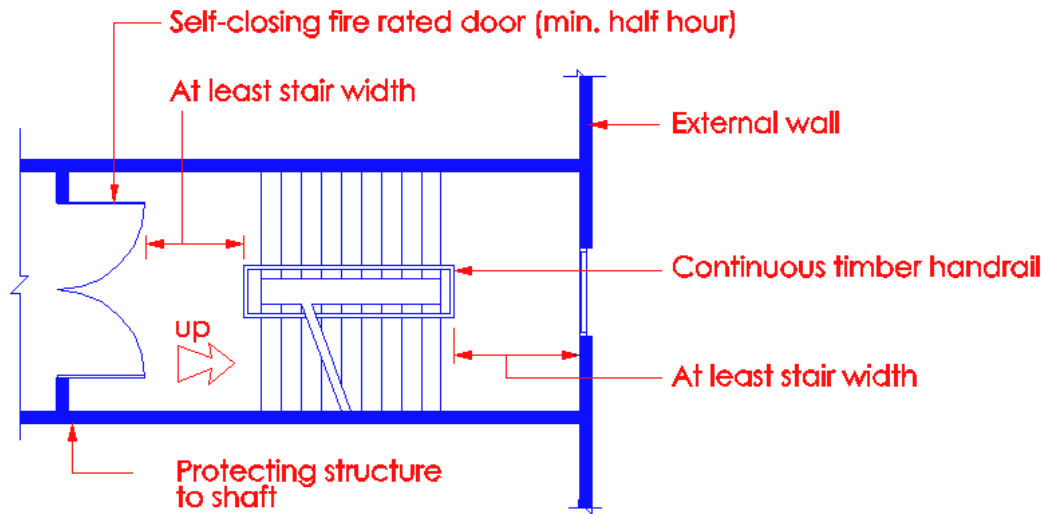

Diagram 3.10.4

The protecting structure, excluding the external wall, to the staircase shall be constructed of masonry. Ceiling/wall and floor finishes shall be of non-combustible materials to ensure that the level of safety in the staircase is maintained at all times. The only exception allowed is the handrail material.

- 3.11.1 Concealed spaces in a building shall be interrupted by construction of cavity barrier to restrict the spread of smoke and flames.

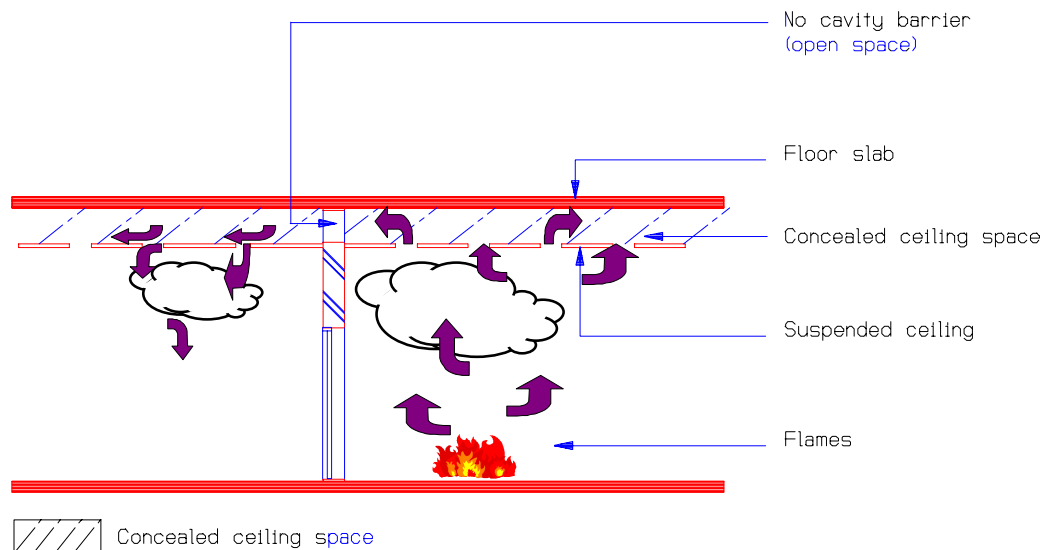

Diagram 3.11.1 - 1

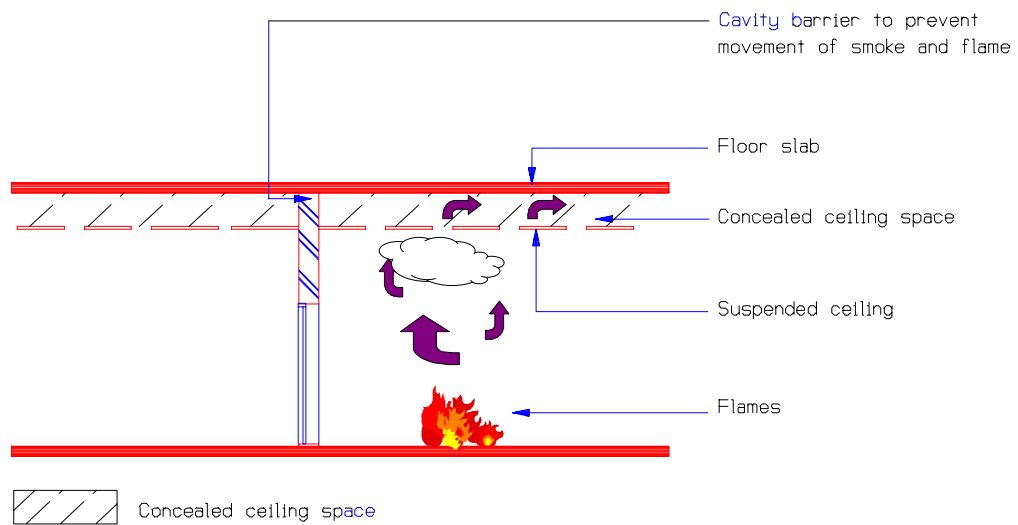

Diagram 3.11.1 – 2

Concealed spaces or cavities in building provide a ready route or flue for smoke and flame to spread undetected for quite some time, thus increasing the risk to life safety of occupants in the building. This is particularly so in the case of void spaces above a suspended ceiling or in a roof space or in a raised floor system. Provisions are available in the Fire Code to reduce the risk of concealed smoke and flame spread by the introduction of cavity barrier when the area or linear dimensions of cavities exceed the limits as per Table 3.11A. Cavity barriers shall be constructed of non-combustible materials and shall have at least half hour fire resistance.

### 3.11.2 Closing the edges of cavities

Cavity barriers shall be used to close the edges of cavities, edges around openings through a wall, floor and any other part of the construction which contains a cavity and to separate any cavity in a wall, floor or any other part of the construction from any other such cavity.



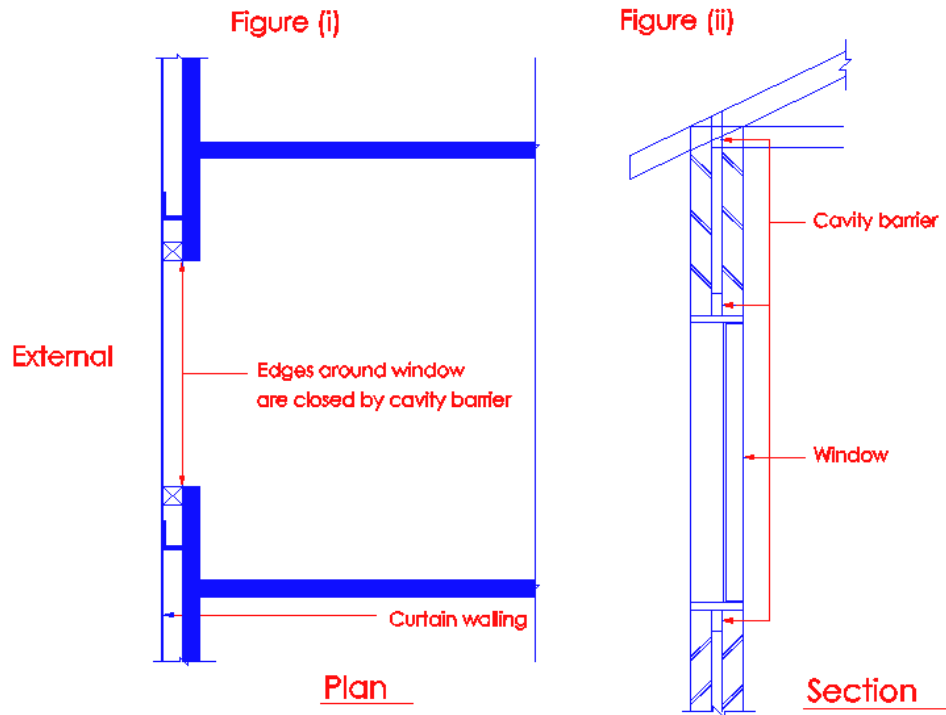

Diagram 3.11.2

“Cavity barrier” means any construction provided to close a cavity against, or restrict the spread of smoke and flame within it.  
 In figure (i) above, cavity barriers are used to close the edges around the window opening. Similar application is provided to window in external cavity wall in figure (ii).

### 3.11.3 Interrupting cavities

Cavities including roof spaces shall be interrupted by cavity barriers where a wall, floor, ceiling, roof or other part of the construction abut the cavity, if there is provision for the element of structure to form a fire resisting barrier. Such cavity barriers shall be of fire resisting construction at least equal to the provision for that required for the fire resisting barrier.

Figure (i)

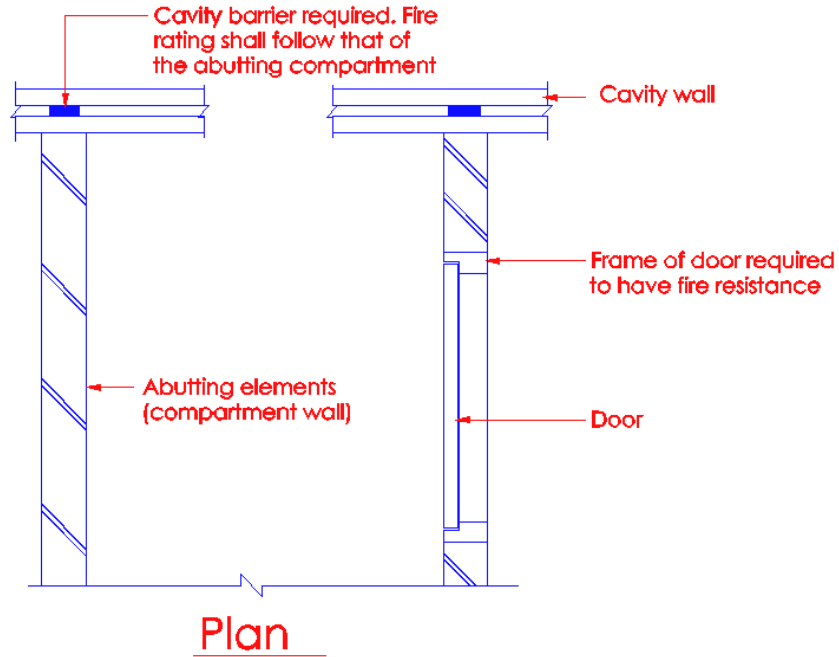

Diagram 3.11.3 – (i)

Cavities must be closed where the fire barrier elements (compartment walls) abut the cavity (including the frame of a door).

Figure (ii)

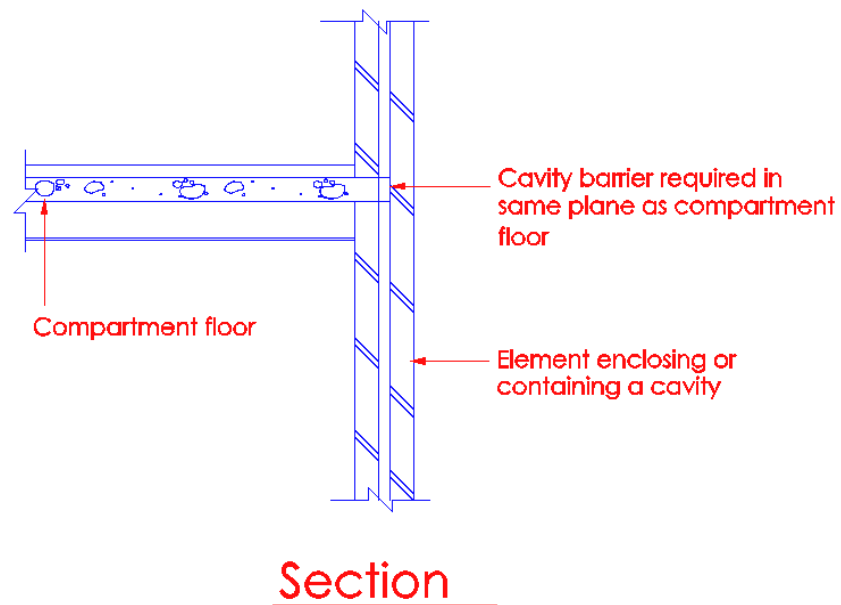

Diagram 3.11.3 – (ii)

Cavity in the walls shall be closed where the compartment floor abuts it.

Figure (iii)

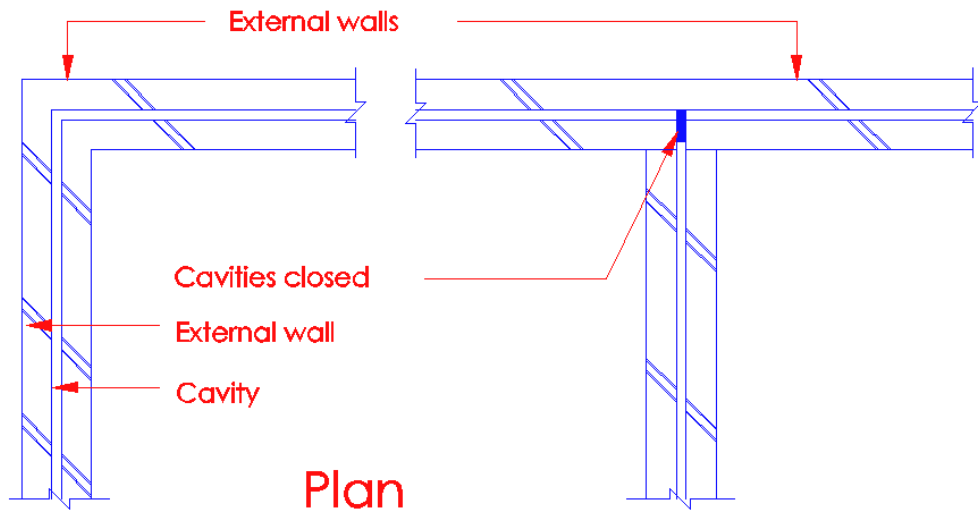

Diagram 3.11.3 - (iii)

Any cavity within an element, or at the junction of two elements, must be closed.

Figure (iv)

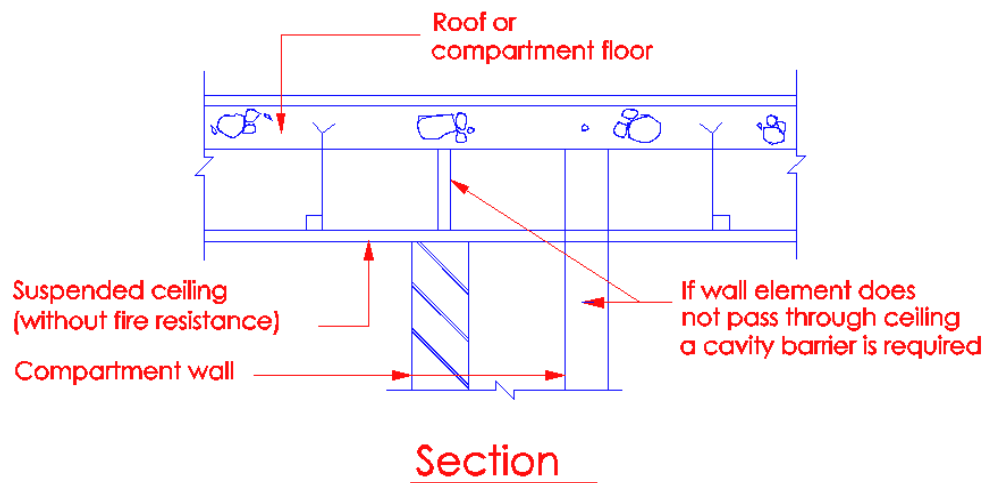

Diagram 3.11.3 - (iv)

It is a common practice to bring the compartment wall right-up to the underside of the structural slab above. The cavity barrier above the compartment wall shall be treated as an extension of the compartment wall below.

Figure (v)

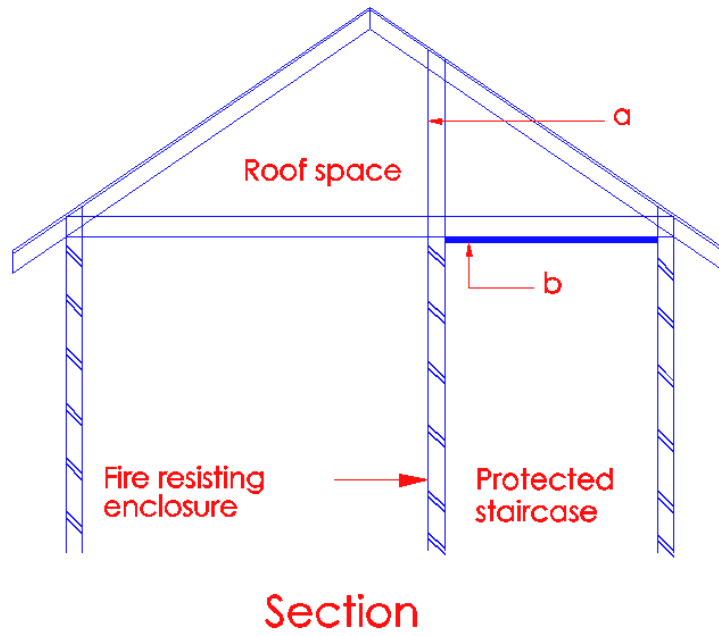

Diagram 3.11.3 – (v)

*The roof space over a protected staircase must be separated by either a cavity barrier at (a) having the same fire rating as the wall of the staircase below, or a fire rated ceiling at (b). See Cl.1.2.8 under Definitions, Vol. 1 for further illustration. Extending the masonry wall right up to the underside of the roof coverings at (a) would meet the requirement under Cl.3.10 of having masonry enclosure to exit staircase.*

#### 3.11.4 Sub-division of extensive cavities

Cavities, including roof spaces, unless otherwise permitted, shall be sub-divided so that the maximum distance between cavity barriers shall not exceed the relevant dimensions given under Table 3.11A.

TABLE 3.11A MAXIMUM DIMENSIONS OF CAVITIES

Location of cavity	Purpose Group of building or compartment	*Class of surface exposed in cavity	Max. dimension in any direction
Between roof and ceiling	I & II	any	no limit
	others	any	20m
Any other cavity	any	Class 0	20m
	any	any	8m
* excluding surface of any pipe, cable, conduit or insulation of any pipe.			

*The main reason of limiting the dimension of cavities is to prevent fire or smoke from spreading widely in large concealed space.*

### 3.11.5 Fire resistance and fixing of cavity barriers

Cavity barriers shall be

- (a) Constructed to provide at least half an hour fire resistance, and
- (b) Tightly fitted to rigid construction or the junctions shall be fire stopped to comply with the requirements of Cl. 3.12.

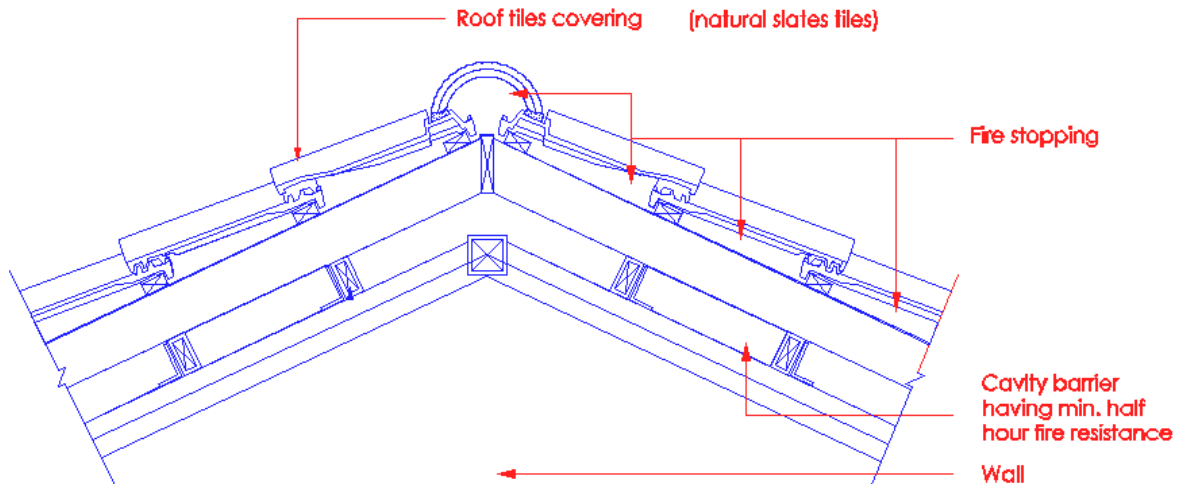

Diagram 3.11.5 – 1

Cavity barriers must be tightly fitted to rigid construction and mechanically fixed in position wherever possible. Where this is not possible (for example, in the case of a junction with slates tiles, corrugated sheeting or similar materials) the junction should be fire-stopped to prevent the spread of fire and smoke in the concealed space.

Cavity barriers must also be fixed so that performance will not be made ineffective by:

- (a) Movement of the building due to subsidence, shrinkage or temperature change; and
- (b) collapse in fire of any services penetrating them; and
- (c) failure in fire of fixings; and
- (d) failure in fire of any material or construction which they may abut. For example, if a suspended ceiling is continued over the top of a fire-resisting wall or partition, and direct connection is made between the ceiling and the cavity barrier above the line of the wall or partition, premature failure of the cavity barrier can occur when the ceiling collapses. However, this does not arise if the ceiling is designed to provide fire protection of 30 minutes or more.

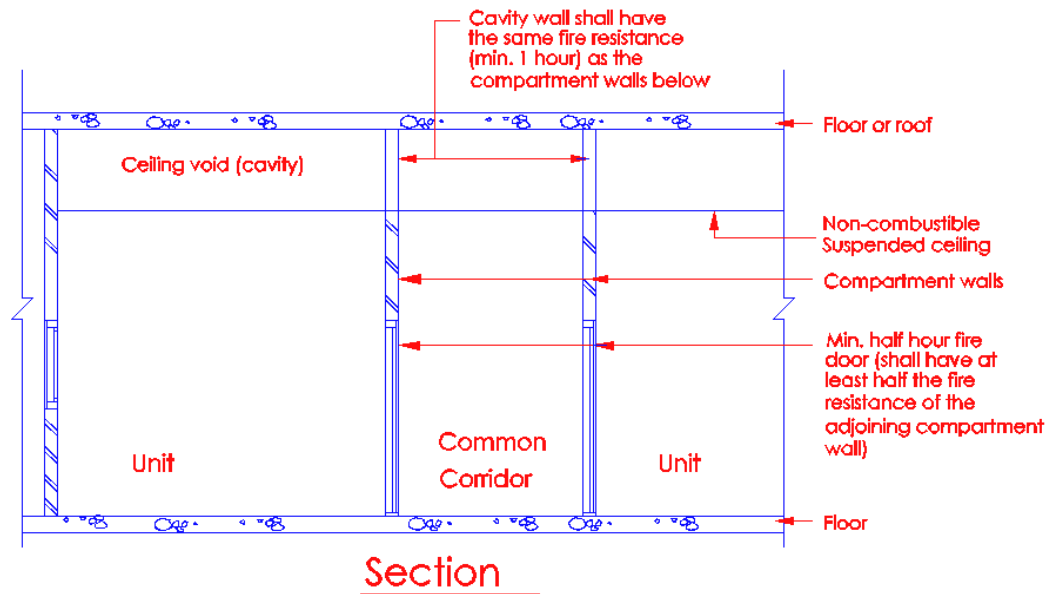

Diagram 3.11.5 - 2

Compartment walls should be carried right up to the full storey height, to a compartment floor above or to the roof coverings, as appropriate. The walls in the ceiling above the common corridor shall not be treated as cavity barriers. They shall be treated as extension of the compartment walls below.

The main purposes of extending the compartment walls into the ceiling space are to complete the compartmentation to each apartment unit and to prevent smoke and fire spread via the concealed ceiling space.

### 3.11.6 Openings in cavity barriers

A cavity barrier shall have no opening in it except for:

- (a) A door which has at least half an hour fire resistance and shall be kept closed all time,
- (b) A pipe which complies with the provision under Cl. 3.9.3,
- (c) A cable or conduit containing one or more cables,
- (d) An opening fitted with suitably mounted automatic fire damper, and
- (e) A duct which is fitted with a suitably mounted fire damper where it passes through the cavity barrier.

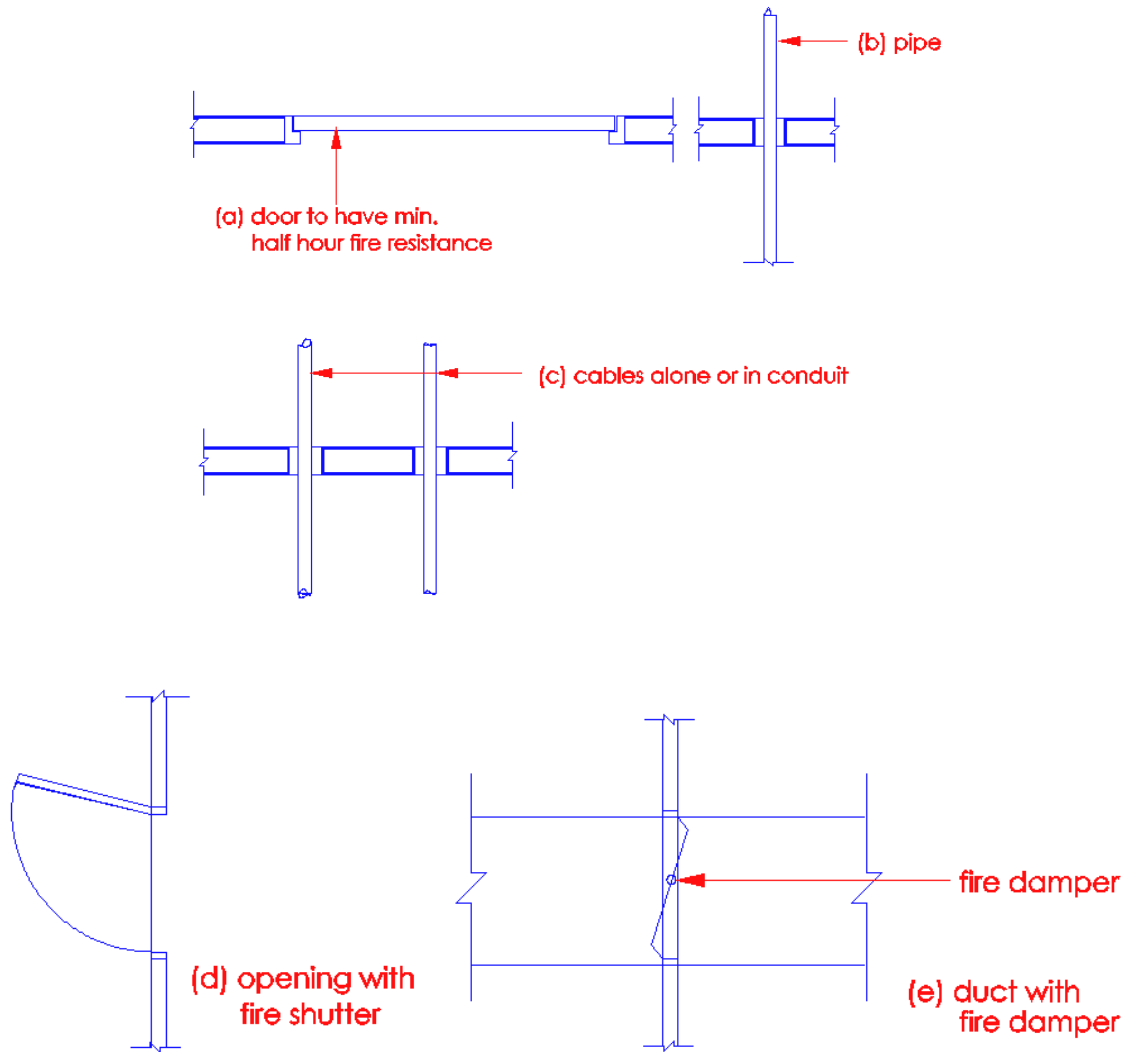

Diagram 3.11.6

*Penetrations of cavity barriers shall be restricted to those illustrated above. All openings through cavity barriers must be no larger than necessary and be fire stopped. The fire stopping shall not restrict thermal movement.*

### 3.11.7 Raised floors for fixed stages and display platforms

The construction of raised floors for fixed stages and display platforms shall comply with the following requirements :

- (a) The concealed space between the structural floor and raised floor shall not be used for storage purpose, and



- (b) No services or installation shall be permitted within the concealed space other than electrical wiring in conduit in compliance with the requirements of SS CP 5 Code of Practice for Wiring of Electrical Equipment of Buildings, and
- (c) All sides shall be properly sealed, and
- (d) The concealed space shall be sub-divided by cavity barriers in compliance with the requirements of Cl.3.11.4 and Table 3.11A.

Raised floor with exposed surfaces in cavity having Class '0' flame spread

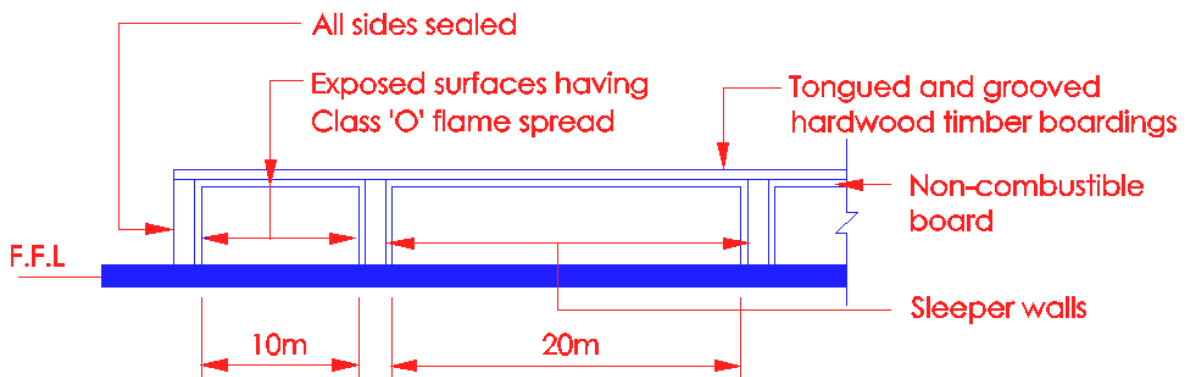

Diagram 3.11.7

*The space between the floor and the raised floor or platform shall not be used for storage purpose. Electrical wiring in the space shall be in conduit in accordance with SS CP 5. Under Table 3.11A, cavity barrier is to be provided at 20m dimension in any direction. Sleeper walls, which are provided for support to the floor or platform, act as a cavity barrier in the concealed space.*

Raised floor with exposed surfaces in cavity having other than Class '0' flame spread

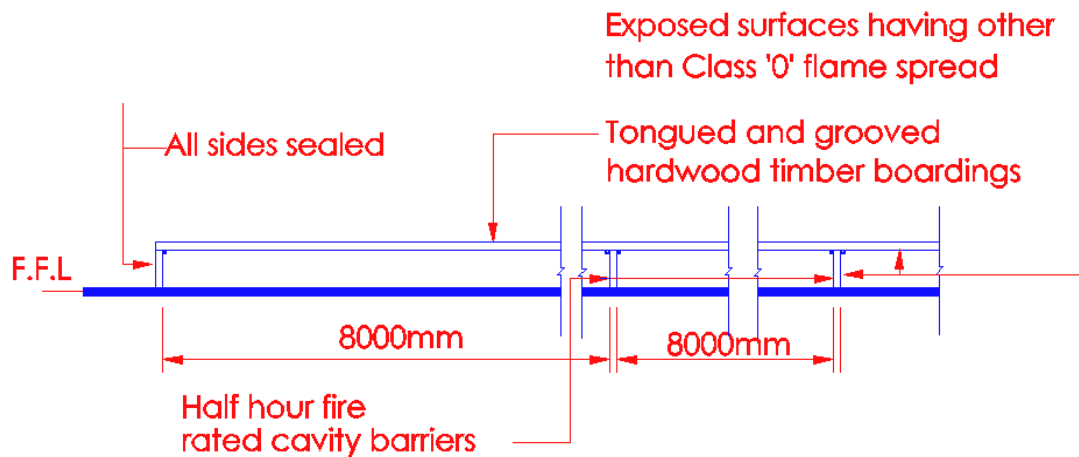

Diagram 3.11.7

The space between the floor and the raised floor or platform shall not be used for storage purpose. Electrical wiring in the concealed space shall be in conduit in accordance with SS CP 5. Under Table 3.11A, cavity barrier is to be provided at 8m dimension in any direction. As such, ½ hour fire rated cavity barriers are provided to sectionalise the concealed space.

3.11.8 Raised floors with or without accessible panels

The construction of raised floors with or without accessible panels shall comply with the following requirements :

- (a) The supporting structure shall be constructed of non-combustible materials having a melting point of at least 800°C, and
- (b) The concealed space between the structural floors and raised floor shall not be used for storage purpose, and
- (c) No services or installation shall be permitted within the concealed space other than
  - (i) electrical wiring in metal conduit and metal trunking in compliance with the requirements of SS CP 5 Code of Practice for Wiring of Electrical Equipment of Buildings;

- (ii) communication cables for computer equipment
- (iii) fire protection installations serving the area, and
- (d) Where the raised floor is used as a plenum, requirements in Cl.7.1.1(f) shall be satisfied, and

*(See clause 7.1.1(f) for illustration)*

- (e) Decking of the raised floor shall be constructed of non-combustible material or where combustible material is used as core material, if allowed in the case of sprinkler protected buildings, the top, bottom, all sides and cut edges shall be covered with material with surface property complying with Class 0 (excluding materials for floor finishes), and

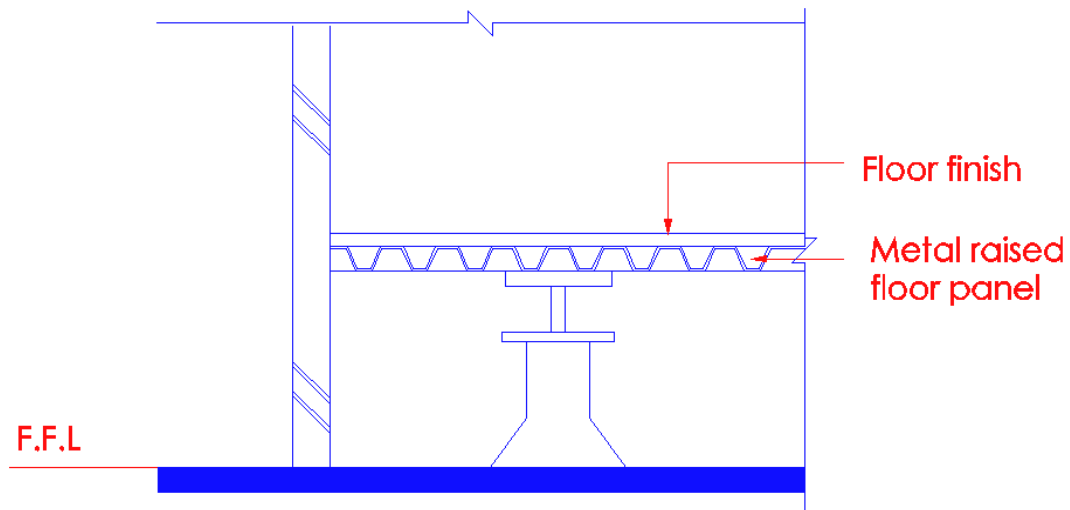

*Non-combustible raised floor panels and supports are allowed to be used in non-sprinkler or sprinkler protected buildings.*

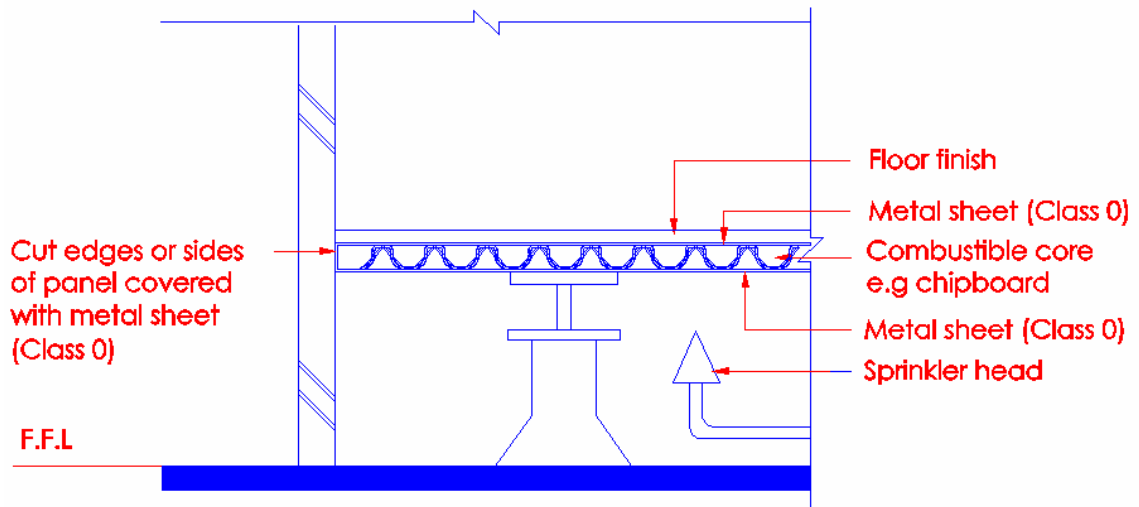

Diagram 3.11.8(e)

*Raised floor panel constructed of combustibile core, eg. chipboard, shall only be allowed to be used in buildings protected by sprinkler system and that the underside of the raised floor is adequately covered by the sprinkler system.*

- (f) In the case of raised floors with accessible panels, access sections or panels shall be provided such that all concealed spaces between the structural floor and raised floor are easily accessible, and
  - (g) Openings in the raised floor for entry of electrical cables shall be effectively closed to prevent entry of debris or other combustibile material into the concealed spaces, and
  - (h) All sides shall be properly sealed, and
  - (i) The concealed space shall be sub-divided by cavity barriers such that the maximum unobstructed area within the concealed space does not exceed 930m<sup>2</sup>, and
- (NB : The floor area of 930m<sup>2</sup> is excessive. To comply with Table 3.11A)*
- (j) Where the concealed space is fitted with an automatic sprinkler system which complies with the requirements in Chapter 6, cavity barriers are not required, and

- (k) The height of concealed space measured between the top of the structural floor and underside of the raised floor decking shall not exceed 400mm and shall be fitted with automatic smoke detection system complying with requirements of SS CP 10 Code of Practice for the Installation and Servicing of Electrical fire Alarm Systems; and in the case of sprinkler protected building, the height of concealed space may exceed 400mm if the space is fitted throughout with an automatic sprinkler system which complies with the requirements in Chapter 6.

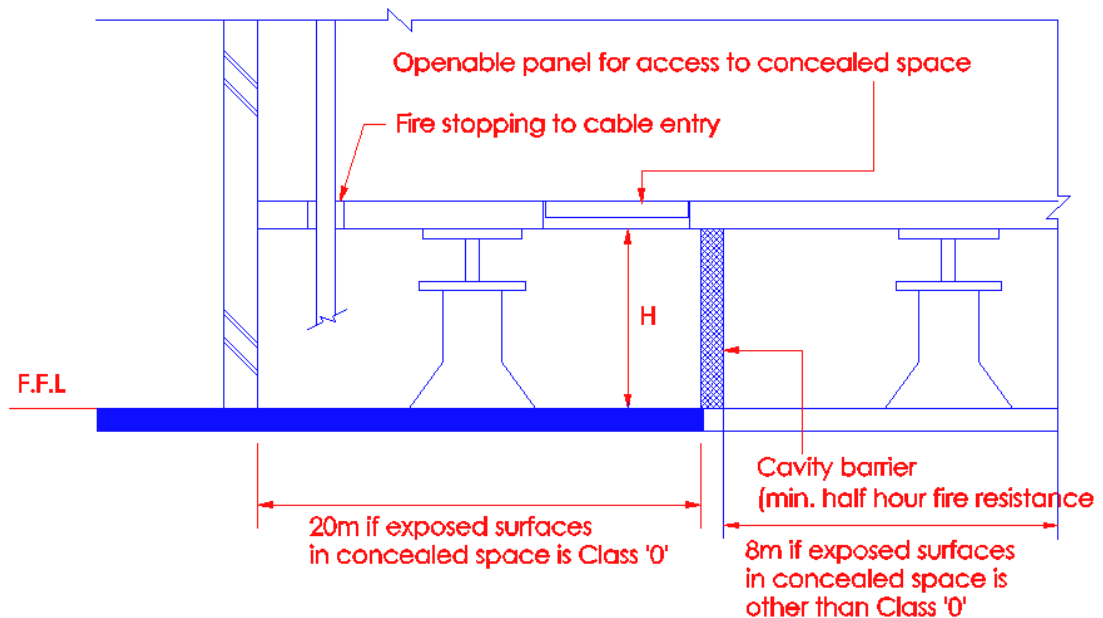

Diagram 3.11.8(g) – (k)

The provision of cavity barriers shall comply with Table 3.11A of the Fire Code.

Non-sprinkler protected building

Cavity barriers shall be provided in accordance with Table 3.11A. The height of concealed space (H), measured between the finished floor level and the underside of the raised floor decking shall not exceed 400mm. The concealed space shall be fitted with smoke detection system in accordance with SS CP 10 Code of Practice for the Installation and Servicing of Electrical fire Alarm Systems. SS CP 10 also allows that smoke detector system is not required to be provided in concealed space which does not exceed 150mm in height – cl.2.1.3.1(b). Sprinkler system is applicable if the height of concealed space exceeds 400mm.

Sprinkler protected building

*Cavity barriers shall be provided in accordance with Table 3.11A. Where the height of the concealed space does not exceed 400mm, smoke detection system complying with SS CP 10 shall be provided. The height of concealed space may exceed 400mm if the space is fitted throughout with sprinkler system. Where sprinkler system is provided inside the concealed space, cavity barriers are not required to be provided – subclause (j).*

3.11.9 Provision for concealed spaces between floor or roof and suspended ceilings

The Relevant Authority may consent to exempt from provision of cavity barriers within the concealed spaces of suspended ceiling, provided the following requirements are complied with :-

- (a) The concealed space shall not be used for storage purpose, and
- (b) The supporting elements shall be constructed of non-combustible material, and
- (c) The exposed surfaces within the concealed space is of class 0 flame spread, (excluding surfaces of any pipe, cable, conduit or insulation of any pipe) and
- (d) In the case of a detector protected building, if the concealed space does not exceed 800mm in depth or if the concealed space is fitted with detectors which comply with the requirements of Chapter 6.
- (e) In the case of a sprinkler protected building:
  - (i) if the concealed space does not exceed 400mm in depth, or
  - (ii) if the concealed space exceeds 400mm and does not exceed 800mm in depth and no combustible material is used within the concealed space, (where the combustible content is small in quantity, the Relevant Authority, may at its discretion, rule that such combustible content may be irrelevant in relation to this sub-clause), or
  - (iii) if the concealed space is fitted with an automatic sprinkler system which complies with the requirements of Chapter 6.

- (f) In the case of other buildings, if the concealed space does not exceed 800mm in depth.

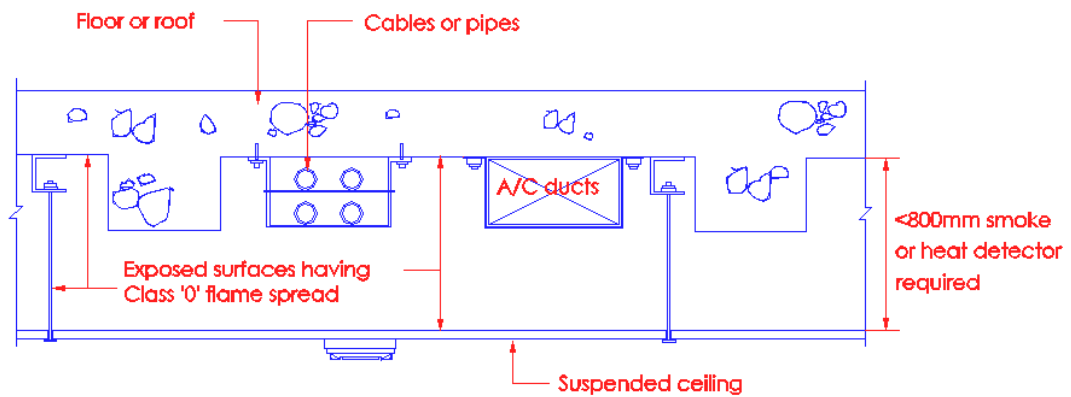

Diagram 3.11.9(d)

Provision of cavity barriers in concealed ceiling space may not be required if the following requirements are complied with :

- the space is not used for storage purpose; and
- the supporting elements eg. ceiling hangers or supports are constructed of non-combustible material; and
- the exposed surfaces within the concealed space is of Class 0 flame spread (excluding surfaces of any pipe, cable, conduit or insulation of any pipe or duct); and
- concealed space does not exceed 800mm in depth; if exceeds 800mm, it shall be fitted with smoke or heat detectors.

Sprinkler protected building - Depth of ceiling space does not exceed 400mm

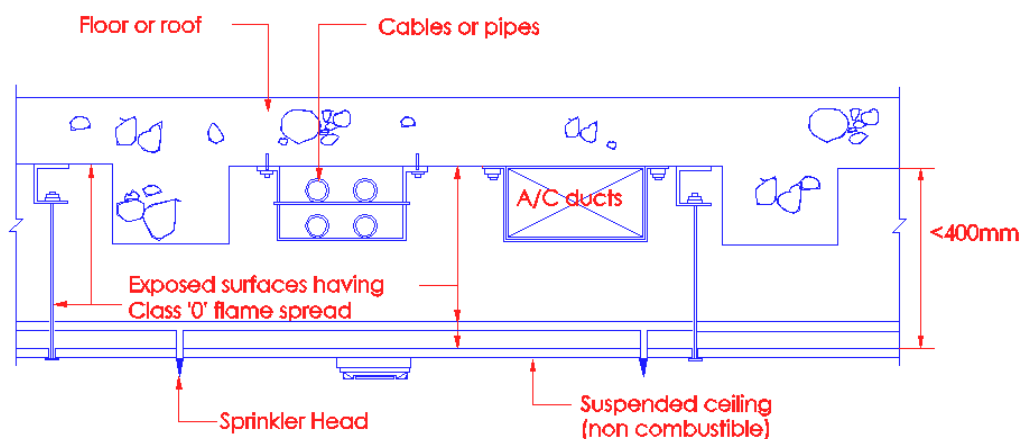

Diagram 3.11.9(e)(i)

Provision of cavity barriers in the concealed ceiling space may not required if the following are complied with :

- a) the space is not used for storage purpose; and
- b) the supporting elements eg. ceiling hangers or supports are constructed of non-combustible material; and
- c) the exposed surfaces within the concealed space is of Class 0 flame spread (excluding surfaces of any pipe, cable, conduit or insulation of any pipe or duct); and
- d) concealed space does not exceed 400mm in depth.

Sprinkler protected building - Depth of ceiling space exceeds 400mm but not exceeding 800mm

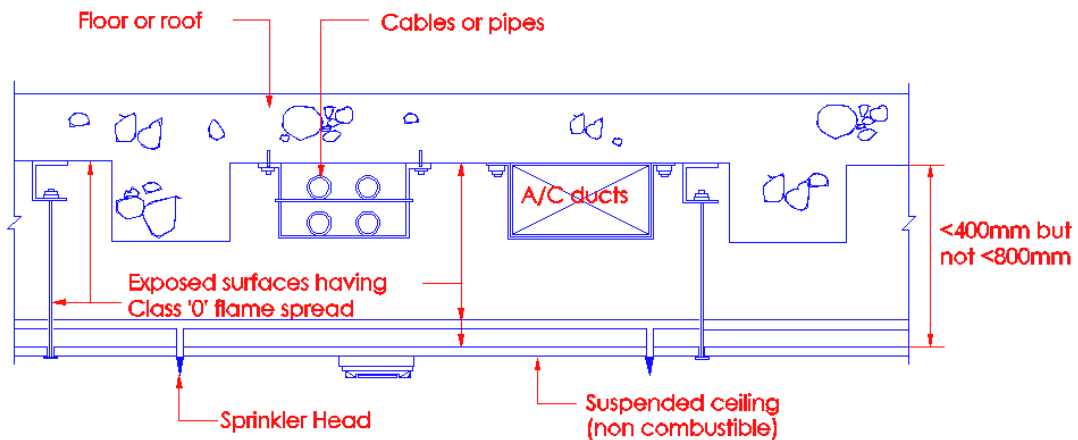

Diagram 3.11.9(e)(ii)

Provision of cavity barriers in the concealed ceiling space may not required if the following are complied with :

- a) the space is not used for storage purpose; and
- b) the supporting elements eg. ceiling hangers or supports are constructed of non-combustible material; and
- c) the exposed surfaces within the concealed space is of Class 0 flame spread (excluding surfaces of any pipe, cable, conduit or insulation of any pipe or duct); and
- d) no combustible material is used within the concealed space. However, where the combustible content is small in quantity, SCDF (FSSD) may, at its discretion grants exemption, provided the space is protected by sprinklers installed on the extended basis under sub-clause 6.6.1.2 of SS CP 52. (whole coverage to be extended to the ceiling)



Concealed space is sprinklered protected – in accordance with Chapter 6

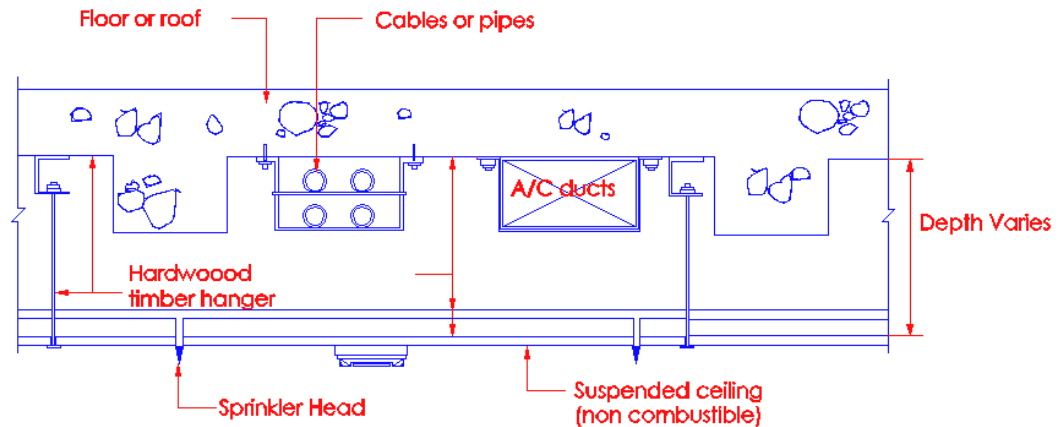

Diagram 3.11.9(e)(iii)

Provision of cavity barriers in the concealed ceiling is not required. See also cl.3.11.10 for further relaxation.

Other building – which neither requires detector nor sprinkler system

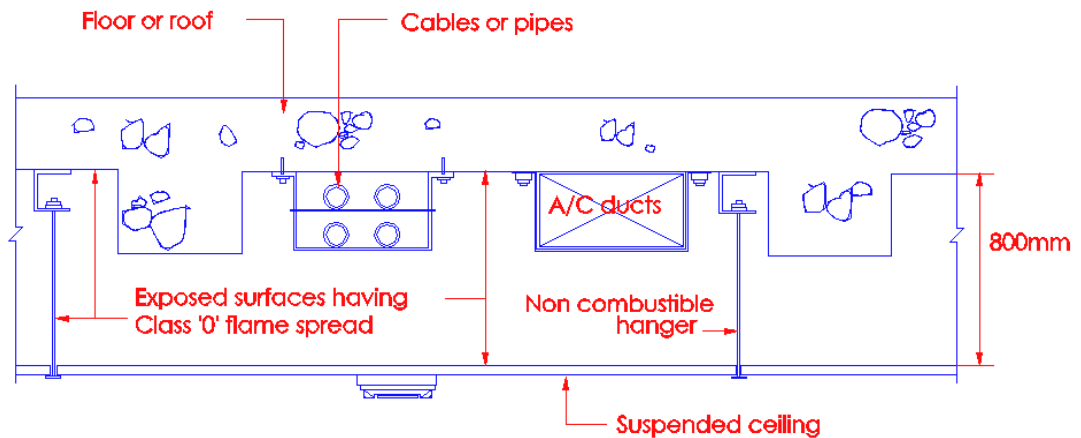

Diagram 3.11.9(f)

Provision of cavity barriers in the concealed ceiling space may not be required if the following are complied with :

- a) the space is not used for storage purpose; and
- b) the supporting elements eg. ceiling hangers or supports are constructed of non-combustible material; and
- c) the exposed surfaces within the concealed space is of Class 0 flame spread (excluding surfaces of any pipe, cable, conduit or insulation of any pipe or duct); and

- d) *concealed space does not exceed 800mm in depth; if exceeds 800mm, it shall be fitted with smoke or heat detectors.*

#### 3.11.10 Exemption of cavity barriers in ceiling space

Where the concealed space of suspended ceiling is fitted with an automatic sprinkler system which complies with the requirements in Chapter 6,

- (a) The concealed space may be exempted from provision of cavity barriers, and
- (b) Combustible materials and materials with other than Class 0 flame spread may be used for the supporting elements and exposed surfaces of materials within the concealed space, provided the ceiling is not situated over an exit passageway, smoke-stop lobby or other designated means of escape facilities.

*(No illustration)*

- i) Where the concealed ceiling space is protected by automatic sprinkler system,  
*the above clause allows the following :*
  - a) *Provision of cavity barrier is exempted;*
  - b) *Combustible materials such as hardwood timber hangers for ceiling; and*
  - c) *Exposed surfaces within the ceiling space may be of any class other than Class 0 flame spread ie. timber members.*
- ii) *The above relaxation shall not apply if the above ceiling construction is situated over an exit passageway, smoke-stop lobby or other designated means of escape facilities.*

#### 3.11.11 Suspended ceiling over protected areas

The concealed spaces of suspended ceiling over an exit passageway, smoke-stop lobby, exit staircase or other designated means of escape facilities, shall comply with the following:

- (a) the ceiling supporting elements and the ceiling shall be constructed of non-combustible materials; and
- (b) the exposed surfaces within the concealed space shall be of Class 0 surface flame spread.

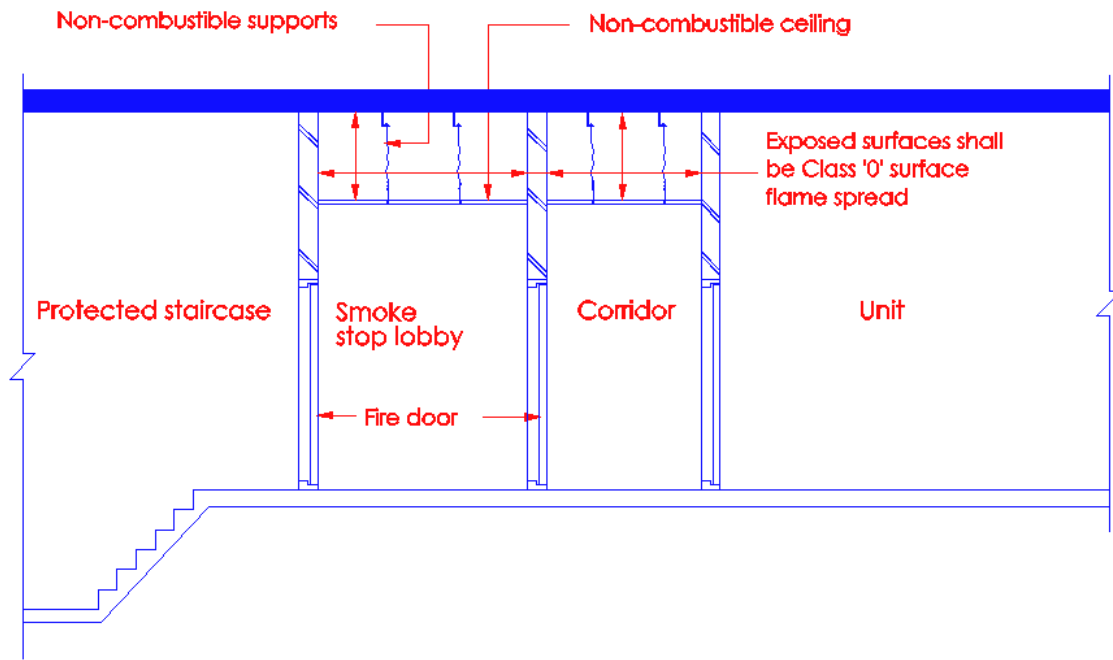

Diagram 3.11.11

The main concern is that spaces meant for safe escape of occupants shall be kept free of combustible materials. Common corridors are treated as escape routes. The exposed surfaces within ceiling space shall have a flame spread rating of Class '0'.

### 3.12 FIRE STOPPING

#### 3.12.1 General provision

Openings for pipes, ducts, conduits or cables which pass through any part of an Element of Structure (except for a part which does not serve as a fire resisting barrier) or Cavity Barrier, shall be :

- (a) Kept as few in number as possible, and
- (b) Kept as small as practicable, and
- (c) All gaps shall be filled with fire-stopping material.

Fire stopping to a pipe  
in a compartment wall

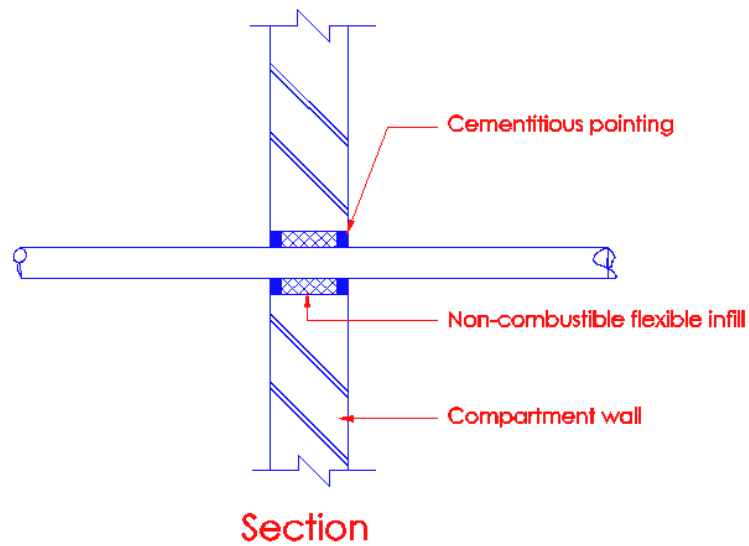

Diagram 3.12.1

Fire stopping is concerned with ensuring that the fire-resisting capability of a component, e.g. separating wall, compartment wall/floor, cavity barrier is not diminished or impaired when penetrated by services for example, a pipe, ducts etc. Therefore whenever gaps are created by the penetration of such pipes, ducts in the fire rated wall/floor, they must be kept as few and as small as possible. The spacing and internal diameter of pipes passing through any elements of structure or cavity barrier shall comply with Cl.3.9.3 and Table 3.9A.

### 3.12.2 Fire stopping

Fire stopping shall be of material having the necessary fire resistance when subjected to test under BS 476 Pt 20 or other acceptable standards.

*(No illustration)*

### 3.12.3 Materials for fire-stopping

Suitable fire stopping materials include:

- (a) Proprietary fire stopping and sealing systems (including those designed for service penetrations) which have been shown by test to maintain the fire resistance of the wall or other element, subject to approval by the Relevant Authority.

- (b) Other fire-stopping materials include:
- (i) cement mortar;
  - (ii) gypsum based plaster;
  - (iii) cement or gypsum based vermiculite/perlite mixes;
  - (iv) glass fibre, crushed rock, blast furnace slag or ceramic based products (with or without resin binders), and
  - (v) intumescent mastics.

The method of fire stopping and choice of materials should be appropriate to the situation and its application.

*(No illustration)*

*To prevent displacement, materials used for fire-stopping should be reinforced with (or supported by) materials of limited combustibility in the following circumstances:*

- (i) in all cases where the unsupported span is greater than 100mm, and*
- (ii) in any other cases where non-rigid materials are used (unless they have been shown to be satisfactory by test).*

*Preference should be given to proprietary fire-stopping and sealing system.*

*When cement mortar or gypsum board plaster or cement or gypsum based vermiculite/perlite mixes is used as fire stopping material, care should be exercised to ensure that workmen properly fill up the entire gaps with the appropriate fire stopping material instead of carrying cosmetic application by just filling up the gaps superficially.*

### 3.13.1 Requirements for Class 0

Any reference to a surface being Class 0 shall be construed as a requirement that -

- (a) The material of which the wall or ceiling is constructed shall be non-combustible throughout; or

- (b) The surface material (or, if it is bonded throughout to a substrate, the surface material in conjunction with the substrate) shall have a surface of Class 1 and if tested in accordance with BS 476: Part 6 shall have an index of performance (I) not exceeding 12 and a sub-index (I) not exceeding 6.

*(No illustration)*

*BS 476:Part 6 refers to a standard fire test for propagation of products. Under this test, there is a means of comparing the contribution of combustible building materials to the growth of a fire by providing a measure of the rate of heat evolution of the samples, exposed in a small combustion chamber.*

*The performance of each sample is expressed as a numerical index from 0 to 100 or more. Low values of the indexes indicate a low rate of heat release. Three to five specimens are tested.*

*Index of performance  $I = i_1 + i_2 + i_3$  where sub-index  $i_1$  is derived from the first three minutes of test,  $i_2$  from the following seven minutes, and  $i_3$  from the final ten minutes. A high index  $i_1$  indicates an initial rapid ignition and heat release.*

### 3.13.2 Requirements for a class other than Class 0 classification

Any reference to a surface being of a class other than Class 0 shall be construed as a requirement that the material which the wall or ceiling is constructed shall comply with the relevant test criteria as to surface spread of flame specified in relation to that class in BS 476: Part 7.

*(No illustration)*

*Test under BS 476: Part 7 refers to a standard fire test for the classification of the surface spread of flame of products.*

*This test is able to determine the tendency of surfaces of flat materials to support the spread of flame across their surfaces and specifies a method of classification appropriate to wall and ceiling linings. Class 1 represents the best performance, followed in descending order by Class 2, Class 3 and Class 4.*

### 3.13.3 Class 0 shall be regarded as the highest class followed in descending order by Class 1, Class 2, Class 3 and Class 4, as set hereunder:

- \* Class 0 - Surface of no Flame Spread. Those surfaces that conform to the requirements of Cl. 3.13.1.

- \* Class 1 - Surface of Very Low Flame Spread. Those surfaces on which not more than 150mm mean spread of flames occurs under the relevant test conditions.
- \* Class 2 - Surface of Low Flame Spread. Those surfaces on which during the first 1-1/2 minutes of test, the mean spread of flame is not more than 375 mm and the final spread does not exceed 450 mm under the relevant test conditions.
- \* Class 3 - Surface of Medium Flame Spread. Those surfaces on which during the first 1-1/2 minutes of test, the mean spread of flame is not more than 375 mm and during the first 10 minutes of test is not more than 825 mm under the relevant test conditions.
- \* Class 4 - Surface of Rapid Flame Spread. Those surfaces on which during the first 1-1/2 minutes of test the mean spread of flame is more than 375 mm and during the first 10 minutes of test is more than 825 mm under the relevant conditions.

*(No illustration)*

*The reason for having Class 0 is that Class 1 covered too wide a range of performance for use in critical areas. Where a higher degree of protection is required, for example in smoke stop lobbies, exit staircases, exit passageways (which constitute the escape route), Class 0 is specified.*

#### 3.13.4 Class of flame spread to be not lower than specified

The surface of a wall or ceiling in a room/space shall be of a class not lower than specified as relevant in the Table 3.13A, provided that -

- (a) Where an automatic sprinkler system is fitted throughout in the building in compliance with the requirements in Chapter 6, there is no control on the surface of flame rating in room / space, except for the following occupancies / usage:
  - (i) Health care facilities, including hospital, nursing home for handicapped, disabled, aged or persons with mental and / or mobility impairments.
  - (ii) Detention facilities.
  - (iii) Exit staircase, exit passageway and smoke-stop / fire fighting lobbies.

- (b) Where a building is not protected by automatic sprinkler system, surfaces of the walls and ceilings may be of a surface class not lower than class 3 to the extent permitted by CI 3.13.5 (a) and CI 3.13.5 (b) respectively.

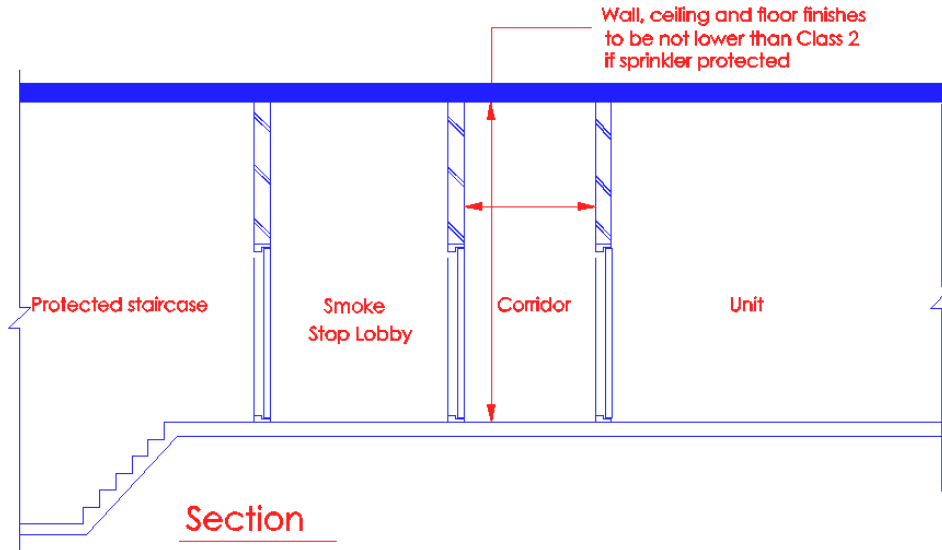

Diagram 3.13.4(b)-1

Wall and ceiling finishes to exit staircase (including exit passageway) shall be of non-combustible materials or Class 0 (if sprinkler protected). For rooms, the extent of wall and ceiling finishes (no control if sprinkler protected or class 1 if not sprinkler protected) shall comply to CI.3.13.5 (a) and (b) respectively.

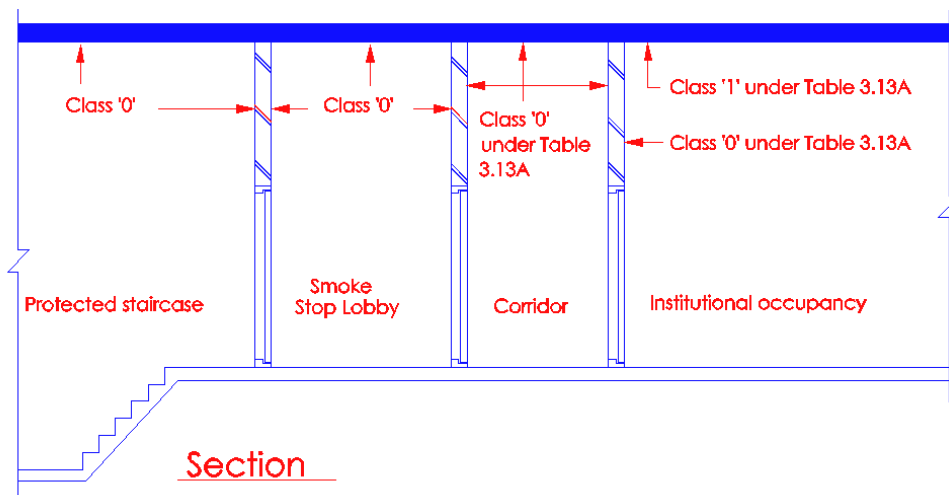

Diagram 3.13.4(b)-2

Where a building is protected by automatic sprinkler system, the surfaces of the walls and ceilings of the circulation space (corridor) and institutional occupancy area can be downgraded by 2 classes subject to Class 3 being the lowest.



For example, surfaces to walls and ceiling of circulation space (corridor) can be of Class 2; institutional occupancy, the surfaces to walls and ceilings can be of Class 2 and 3 respectively. For classification of surfaces of walls and ceilings relating to flame spread, Table 3.13A and cl.3.13.5 are to be cross-referred and complied with respectively.

- (c) If timber is used as the surface material for the walls along the side gangways of the auditorium which is not sprinkler protected, the requirements of this regulation pertaining to the requisite class of flame spread may be relaxed only in respect of those parts of such wall surfaces provided the aggregate area of such parts does not exceed 50 percent of the whole surface area of the side walls of the auditorium.

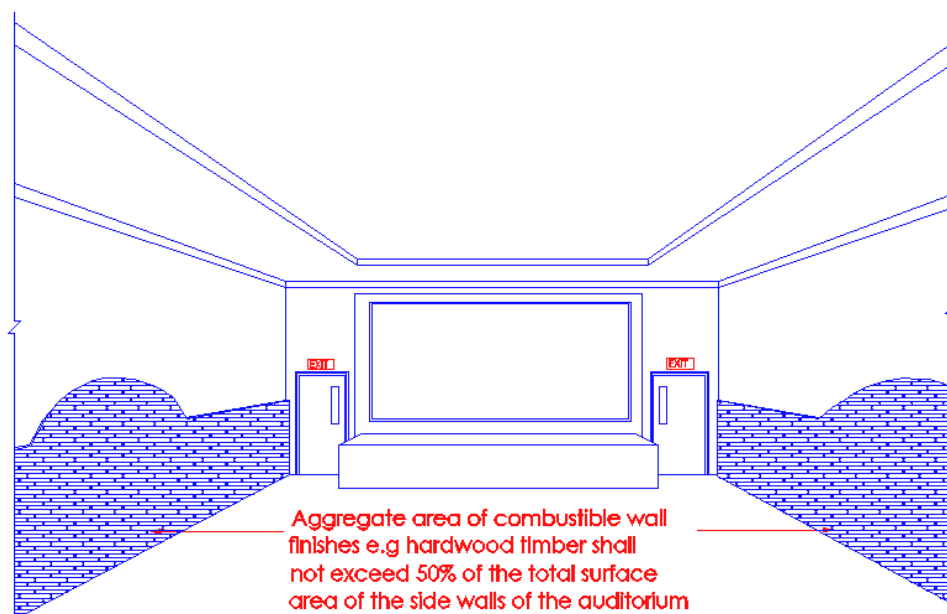

Diagram 3.13.4(d)

In the design of the auditorium, there is a need to meet the acoustic requirements. Timber was then considered as a preferred material for use. The above clause provides the relaxation for the use of timber as wall linings, provided the aggregate area of the timber linings does not exceed 50% of the whole surface area of the side walls of the auditorium. The other reason for the above relaxation is that each auditorium is required to be constructed as a fire compartment.

3.13.5 Where class of flame spread may be of any class not lower than class 3

(a) Any part of the surface of a wall in a room or compartment may be of any class not lower than Class 3 if the area of that part ( or if there are two or more such parts, the total area of those parts) does not exceed the following -

(i) in the case of a building or compartment of purpose group III, 20 m<sup>2</sup> ,

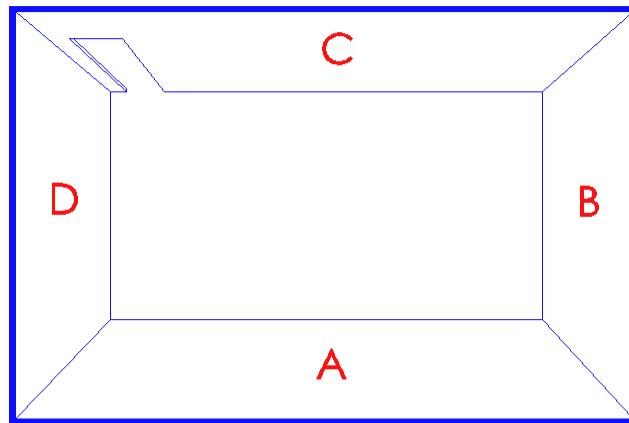

Planal/Isometric view

Diagram 3.13.5(a)(ii) - 1

Computation of 20m<sup>2</sup> will be based on total surface areas of walls in a room having not lower than Class 2, if sprinklered protected. In the above diagram, the total surface area of the 4 walls, if finished with Class 2 materials shall not exceed 20m<sup>2</sup>. (Please note that under Purpose Group III [Institutional], the class of flame spread for walls is Class 'O'. Therefore, if sprinkler system is provided, Class '2' would be the lowest)

Fig i)

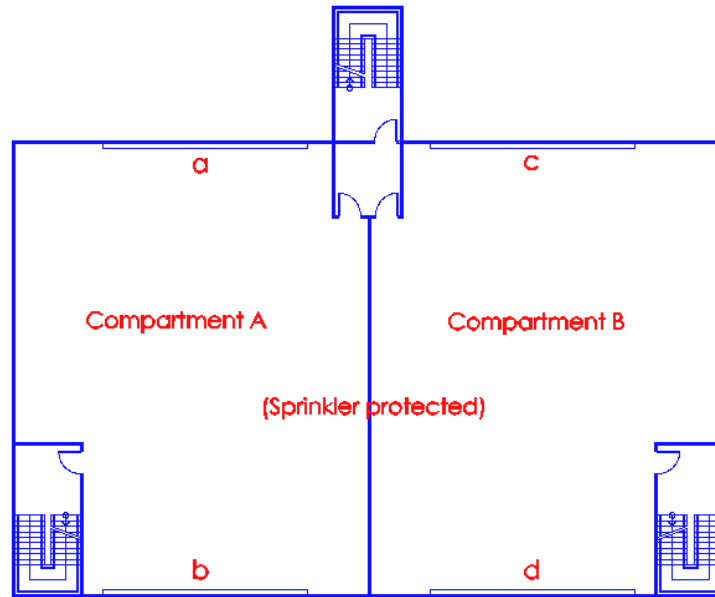

a + b = max. 60sq.m  
c + d = as above

Diagram 13.5(a)(ii) - 2

In the above diagram there are two compartments. Each compartment can have a total of 20m<sup>2</sup> of combustible wall finishes of not lower than Class 2. Subsequently, if the compartment wall is removed, there is a need to review the provision of wall finishes, subject to the total wall finishes to the whole floor shall not exceed 20m<sup>2</sup>. Area of wall finishes in excess of 20m<sup>2</sup> is required to be removed.

Fig ii)

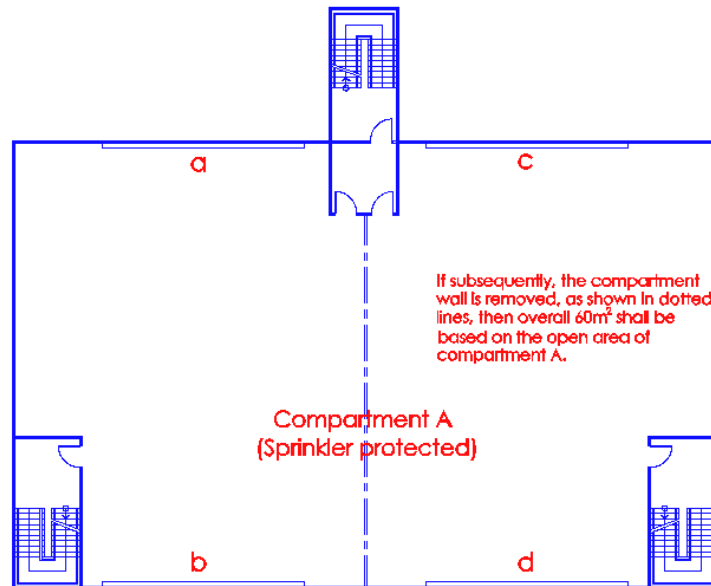

a + b = max. 60sq.m  
c + d = as above

Diagram 3.13.5(a)(ii) - 3

In the above diagram, if subsequently the compartment wall as shown in dotted lines is removed, the overall 20m<sup>2</sup> shall be based on total floor area of compartment A.

Fig (iii)

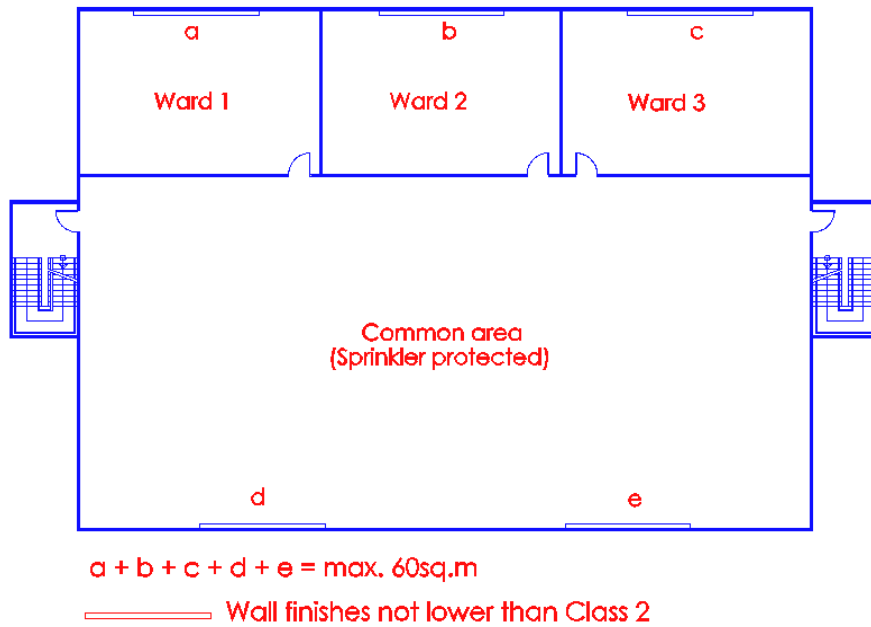

Diagram 3.13.5(a)(ii)

In the above diagram, a compartment is subdivided into rooms, the combustible wall finishes of max. 20m<sup>2</sup> per compartment will apply to the rooms and the common area.

For wall finishes, the total area of 20m<sup>2</sup> excludes :

- (i) door frames and unglazed parts of doors;
  - (ii) window frames and frames in which glazing is fitted;
  - (iii) architraves cover moulds, picture rails, skirtings and similar narrow members; and
  - (iv) fitted furniture.
- (b) Any part of the surface of a ceiling may be of any class not lower than Class 3 if that part of the surface is the face of a layer of material the other face of which is exposed to the external air (skylight included) and -

- (i) \* the ceiling is that of a room in a building or compartment of purpose group III or that of a circulation space excluding smoke-stop lobby, exit staircase and exit passageway in a building or compartment of any purpose group, and
- \* the area of that part does not exceed 2.5 m<sup>2</sup>, and
- \* the distance between that part and any other such part is not less than 3.5 m, or

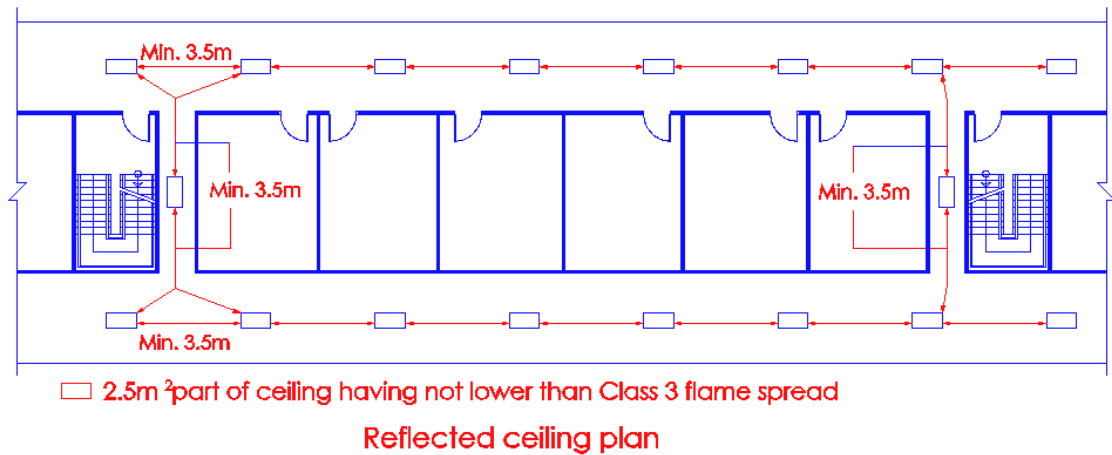

Diagram 3.13.5(b)(i)

The above clause is intended for lighting diffuser. Any part of a ceiling to circulation space eg. corridor may have not lower than class 3 flame spread, provided each part shall not exceed 2.5m<sup>2</sup> and is separated from other such part by minimum 3.5m.

- (iii) that part and all other such parts are evenly distributed over the whole area of the ceiling and together have an area which does not exceed 20% of the floor area of the room, or

Unenclosed loading/unloading platform

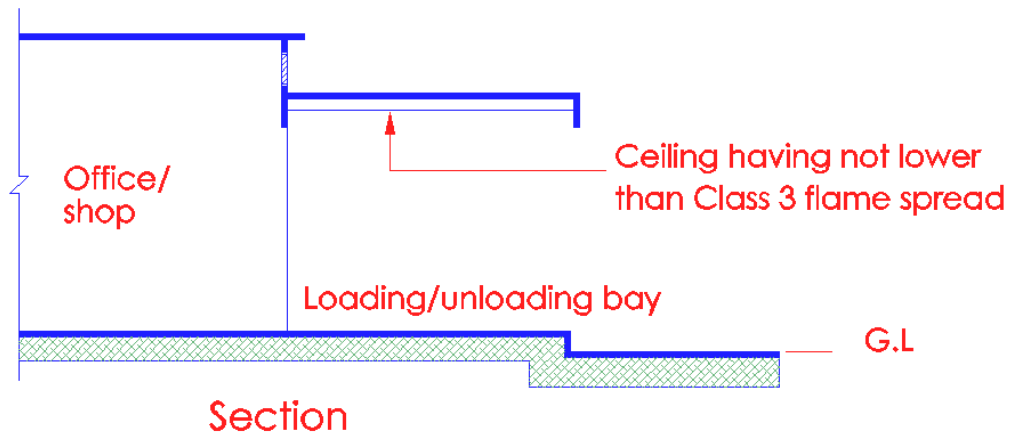

Diagram 3.13.5(b)(iii)

Covered linkway connecting 2 buildings

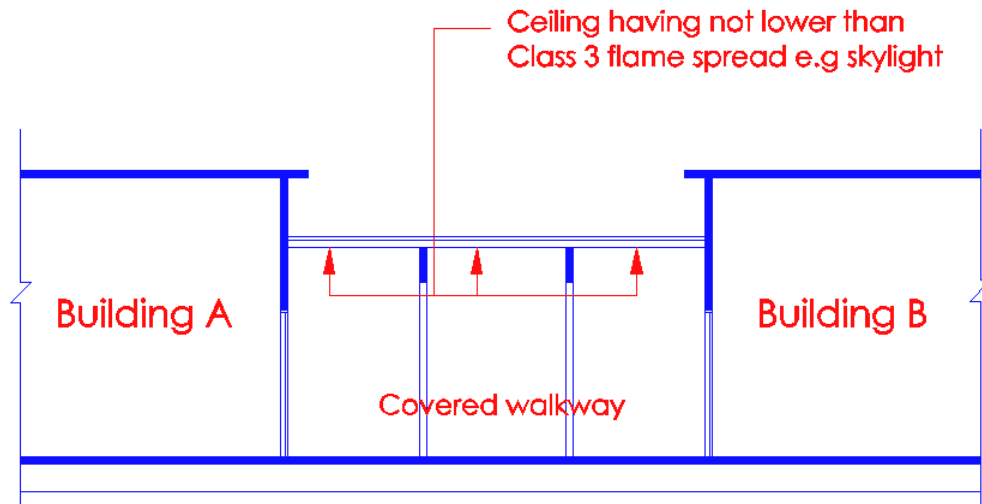

Diagram 3.13.5(b)(iii) - 2

In-addition to the above, ceilings to balcony, verandah, open carport are also allowed to have not lower than Class 3 flame spread. The above relaxation is allowed as the ceilings are located at the periphery of the building where smoke and heat could easily be dispersed into the exterior air.

Any material, including gypsum board or plaster board, which satisfies the requirements under clause 1.2.42 as non-combustible material is to be treated as acceptable under the above clause, regardless of the presence of the 0.5mm thick paper facing.

- (iv) the ceiling is that of a balcony, verandah, open carport, covered way or loading bay which (irrespective of its floor area) has at least one of its longer sides wholly and permanently open, or
- (v) the ceiling is that of a garage or outbuilding which (irrespective of whether it forms part of a building or is a building which is attached to another building or wholly detached) has floor area not exceeding 40 m<sup>2</sup>.

### 3.13.6 Exception

Wall and ceiling finishes in the form of thin sheet of not more than 1.0 mm thickness mounted on a non-combustible substrate will not be subject to the requirement of surface spread of flame provisions provided that this exception shall not apply to smoke-stop / fire fighting lobbies, exit staircases and passageways.

*(No illustration)*

*The above clause grants relaxation on the control of wall and ceiling finishes which are not more than 1.0mm thick mounted on non-combustible substrate, provided these finishes are not used in smoke-stop lobbies, exit staircases and exit passageways. The main concern is that all protected routes meant for escape of occupants shall be kept free of combustible finishes. The above finishes include material such as gypsum board.*

*Non-combustible boards, for example gypsum board, which meet the requirements of Cl.1.2.42 would be allowed to be used for the construction of smoke-stop lobbies, exit staircases and exit passageways.*

## 3.14 ROOFS

### 3.14.1 Roof construction

Surface of materials for roof covering and roof construction shall have a surface spread of flame rating not lower than class 1, except in the case of buildings that are protected throughout with automatic sprinkler system in compliance with Chapter 6.

*(No illustration)*

### 3.14.2 Provision for buildings not exceeding four storeys

The Relevant Authority may consent to the use of combustible material for roof construction for buildings of purpose group III, which satisfy the following requirements :

- (a) Building does not exceed four storeys, and
- (b) Roof space between the roof and the ceiling shall be sub-divided by cavity barriers where required to comply with the relevant provisions of Cl. 3.11, and openings in cavity barriers shall be fire-stopped to comply with the requirements of Cl. 3.12, and

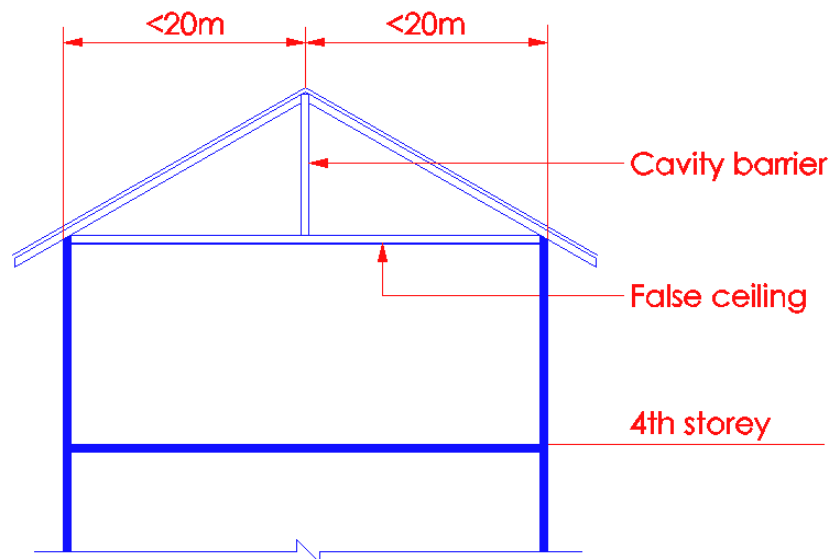

Diagram 3.14.2(b)

*The provision of cavity area barrier is to prevent the spread of fire in the roof spaces. Any service penetration to the cavity barrier shall be fire stopped.*

*The cavity barrier shall have minimum ½ hour fire resistance rating.*

- (c) If the underside of the roof serves as the ceiling to a room or space, the elements of the underside of the roof shall comply with the relevant provisions of Cl. 3.13 for restriction of spread of flame.



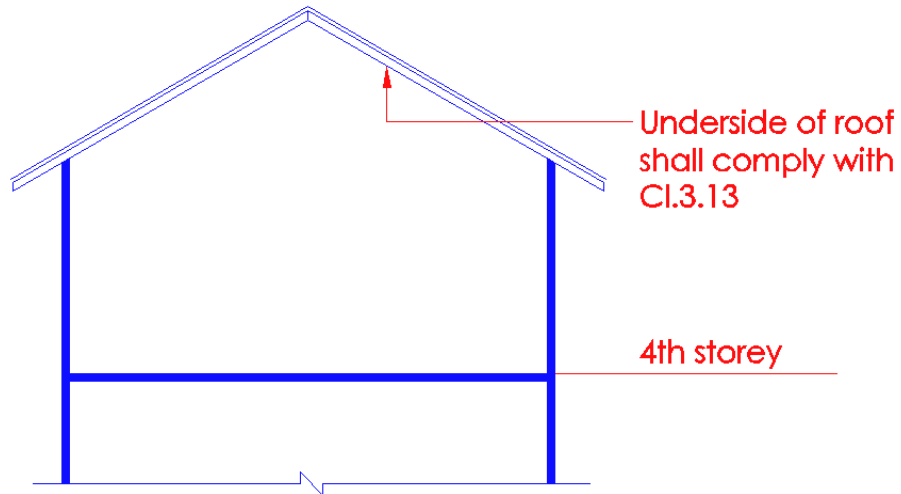

Diagram 3.14.2(c)

Where false ceiling is not provided, the underside of the roof would be considered as the ceiling to the space below. Hence, there is a need to control the surface flame spread of the exposed underside of the roof construction.

#### 3.14.3 Roof junction with separating wall and compartment wall

At the junctions with separating wall or compartment wall, roof construction shall comply with the relevant requirements under Cl.3.6.3 and Cl.3.7.4 respectively.

*(See illustration and comments under Cl.3.6.3)*

#### 3.14.4 Roof terrace

Roof terrace shall not be roofed over. If it is either partially or fully roofed over, it shall be considered as a habitable floor.

Not acceptable

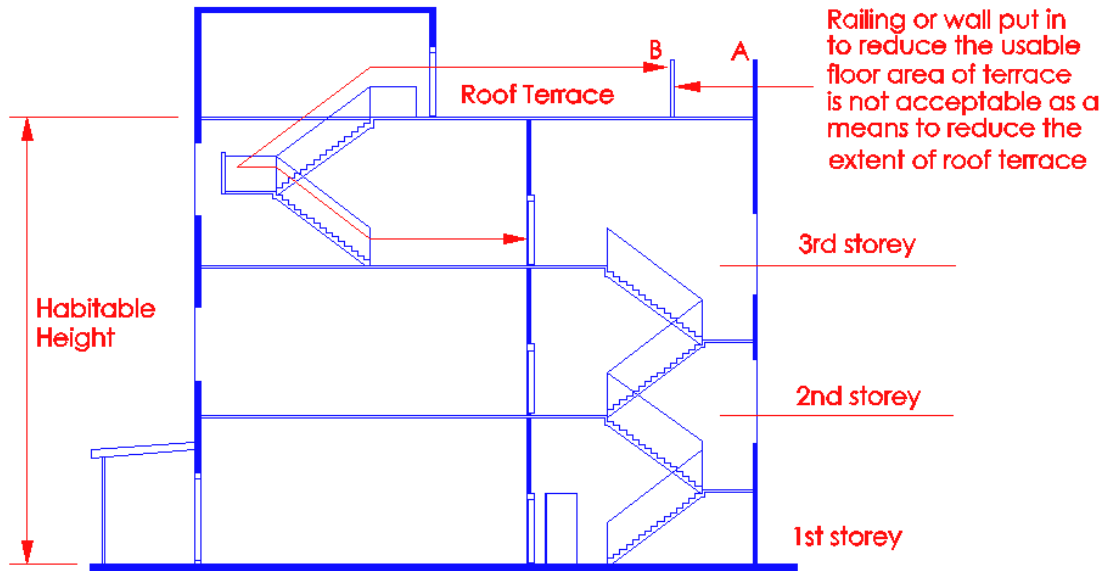

Diagram 3.14.4

Roof Terrace

a) Means of escape

Roof terrace even if not roofed over could be used by building owners to hold private functions. In this respect, the roof terrace would attract additional occupant load, which could be sizeable, depending on the type of function proposed, for example, a private dinner function could be held on the open roof terrace. The guests and the hosts that are attending the private function on the roof terrace would be subject to the risk of a fire that could break out in any of the floor space below the roof terrace. For this reason, roof terrace, whether roof over or not should be subjected to compliance with exit capacity and travel distance requirements under the fire code. Roof terrace which exceeds the floor area of 60sq. m shall be provided with a separate exit at terrace level.

b) Habitable height

For the purpose of determining the habitable height of a building, roof terrace that is either partially or fully roofed over shall be considered as a habitable floor. Thus, if the roof terrace is the highest habitable floor, the habitable height of a building shall be measured from the lowest level of the fire engine access road to the finished floor level of the highest habitable floor.

In the above diagram, the habitable height of the building shall be measured up to the finished floor level of the terrace. Otherwise it shall be measured up to the finished floor level of the 3<sup>rd</sup> storey.

### 3.15 MATERIALS FOR CONSTRUCTION

3.15.1 (a) Materials used in the construction of building elements shall comply with the provisions stated under this section in addition to the performance requirements such as for fire resistance and limit to spread of flame as stipulated in other relevant sections of the code.

(b) Intumescent Paints

Intumescent paints is allowed to be used for protection of structured steel members of all buildings, to achieve the required fire resistance, provided :

- (i) the paint shall be of a proprietary system that has been demonstrated to achieve the fire resistance performance as required in BS 476 Part 20/21 or its equivalent, together with the specified weathering tests as specified in the BS 8282: Part 2 – 1992;
- (ii) they shall be used to protect structural beams only, excluding load transfer beams, if the habitable height of the building exceeds 24m.
- (iii) coating of intumescent paint onto structural steel, and subsequent maintenance shall conform to BS 8202: Part 2: 1992; and
- (iv) all requirements stipulated in the Appendix to this clause: "Notes on the use of Intumescent Paints for Protection to Structural Steel Members of Buildings" shall be complied with. (Please see Appendix (F))

*(No illustration)*

*The above sub-clause specifically prohibits the use of intumescent paints. In the construction of mezzanine floor where steel joists may be used, other form of fire protection to the steel members should be used, for example, sprayed-on protection. The main concern for not accepting intumescent paints for steel work protection is the durability of the material in our climatic conditions. The intumescent paints work well in climatic condition where the percentage of humidity does not exceed 75%.*

- (c) Flame retardant chemicals are permitted to be used for upgrading of fire resistance rating or surface spread of flame of timber or any combustible materials, subject to the following:
- (i) The chemical treatment process is part and parcel of the manufacturing process to produce the finished product ;
  - (ii) The chemical treatment is by means of pressure impregnation conforming to SS CP: 1 – Use of Timber in Building Construction, or the manufacturer's specification in accordance to the prototype test, for timber and other combustible materials respectively.
  - (iii) The treated materials/products have been subjected to fire test as required under Cl 3.4.1 or Cl 3.13.1

*(No illustration)*

*For lining of walls and ceilings, and construction of mezzanine floor, flame retardant chemicals shall not be used to treat the timber members or other combustible materials to meet surface flame spread and fire resistance rating requirements respectively.*

*The main concerns for not accepting flame retardant chemicals are :*

- i) there is no guarantee of the permanency of the flame retardant chemicals in the wood or other combustible materials;*
- ii) the flame retardant chemicals are toxic elements, which when subjected to flaming would produce large quantities of toxic gases.*

3.15.2 All elements of structure shall be constructed of non-combustible materials in addition to the relevant provisions as follows:

Cl.3.3 for fire resistance of elements of structure,

Cl.3.5.1, 3.5.2 & 3.5.4 for External Walls,

Cl.3.6.1 (c)/(d) & 3.6.5 for Separating Walls,

Cl.3.7.1 (c)/(d), 3.7.5 & 3.7.6 for Compartment Walls and Compartment Floors,

Cl.3.8.2(c), 3.8.4, 3.8.7(c), 3.8.8(b), 3.8.8(e) and 3.8.9(a) for Protected shafts.

- 3.15.3 Materials used for the protection of openings shall comply with the relevant provisions of cl.3.9 of the code for protections of openings.
- 3.15.4 Exit staircases shall be constructed of non-combustible materials to comply with the provision of cl.3.10.1.  
*(See Cl.3.10.1 to 3.10.4 for illustration and explanation)*
- 3.15.5 Materials used for the construction of raised floors shall comply with provisions of cl.3.11.8(a) and cl.3.11.8(e).
- 3.15.6 Materials used for construction of ceiling and its supports shall comply with Table 3.13B, except for supports that are required to comply with cl.3.11.9 (b).
- 3.15.7 Construction of ceilings and ceiling support located within sprinkler protected building shall comply with the provisions of cl.3.11.10(b).
- 3.15.8 Materials used for fire stopping shall comply with the relevant provisions of cl.3.12.2 and 3.12.3.
- 3.15.9 Materials used on the surfaces of walls and ceilings are required to meet the requirements for restriction of spread of flame and to comply with the performance requirements as stipulated under cl.3.13.
- 3.15.10 Materials used for roof construction shall comply with the provisions of cl.3.14.1 & 3.14.2.
- 3.15.11 Internal non-load bearing walls in buildings shall be constructed of non-combustible material and the materials for surface finishes of internal non-load bearing walls shall not be treated as part of the wall and shall comply with the relevant provisions of Cl.3.13.  
*(No illustration)*  
*Materials for surface finishes of all the walls, non-loading bearing, separating and compartment walls shall comply with Cl.3.13.5 and Cl.3.13.6.*
- 3.15.12 (a) Composite panels which consist of plastic core shall not be used either for the construction of internal non-load bearing walls, ceilings, external walls or as cladding to external walls of all buildings unless prior approval has been obtained from the Relevant Authority.

- (b) Materials with surface flame spread rating of not lower than Class 2 shall be permitted to be used for the construction of partition for toilet cubicles only.

*(No illustration)*

*There are many types of composite panels, having different thickness and properties of combustible core. The main concern is the combustible core of the panels, which could readily ignite and help fire spread externally from floor to floor of a building.*

*Qps shall consult and obtain SCDF (FSSD)'s approval on the use of any composite panels in their building project before making submission of building plans.*

- 3.15.13 Fire rated glass wall/door to compartment walls, compartment floors, smoke stop lobby and fire fighting lobby, and protected shafts not containing exit staircase and fire lift.

In buildings which are protected by an automatic sprinkler system, fire rated glass can be used for the construction of compartment walls, compartment floors, enclosures to smoke stop lobby and fire fighting lobby, and protected shafts not containing exit staircase and fire lift, subject to the following:

- (a) The walls and doors shall have the necessary fire resistance, including insulation, when subject to test under BS 476: Part 20-23; and
- (b) The walls and doors shall meet the class A of the Impact Performance requirements when subject to test under BS 6206 or AS 2208.

- 3.15.14 Internal non-load bearing walls, ceilings and finishes shall not contain any plastic material.